



**THE DATASHEET OF  
NCP715SQ18T2G**



# NCP715

## 50 mA Ultra-Low Iq, Wide Input Voltage, Low Dropout Linear Voltage Regulator

The NCP715 is 50 mA LDO Linear Voltage Regulator. It is a very stable and accurate device with ultra-low ground current consumption (4.7  $\mu\text{A}$  over the full output load range) and a wide input voltage range (up to 24 V). The regulator incorporates several protection features such as Thermal Shutdown and Current Limiting.

### Features

- Operating Input Voltage Range: 2.5 V to 24 V
- Fixed Voltage Options Available: 1.2 V to 5.3 V
- Ultra Low Quiescent Current: Max. 4.7  $\mu\text{A}$  Over Full Load and Temperature
- $\pm 2\%$  Accuracy Over Full Load, Line and Temperature Variations
- PSRR: 52 dB at 100 kHz
- Noise: 190  $\mu\text{V}_{\text{RMS}}$  from 200 Hz to 100 kHz
- Thermal Shutdown and Current Limit protection
- Available in XDFN6 1.5 x 1.5 mm and SC-70 (SC-88A) Package
- These are Pb-Free Devices

### Typical Applications

- Portable Equipment
- Communication Systems

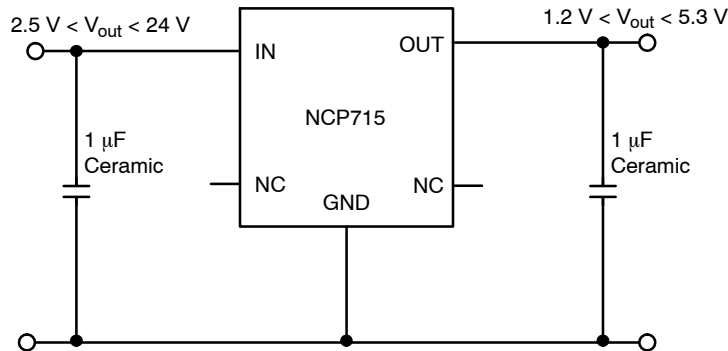

Figure 1. Typical Application Schematic



ON Semiconductor®

[www.onsemi.com](http://www.onsemi.com)

### MARKING DIAGRAMS

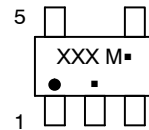
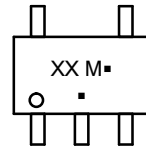
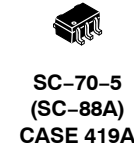
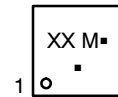

XX = Specific Device Code  
M = Date Code  
▪ = Pb-Free Package  
(Note: Microdot may be in either location)

### ORDERING INFORMATION

See detailed ordering and shipping information in the package dimensions section on page 18 of this data sheet.

# NCP715

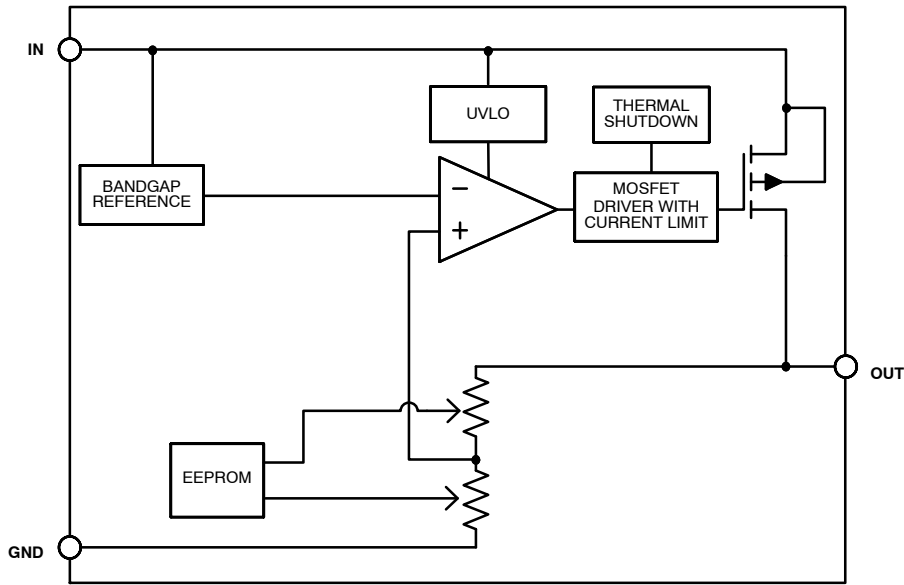

Figure 2. Simplified Block Diagram

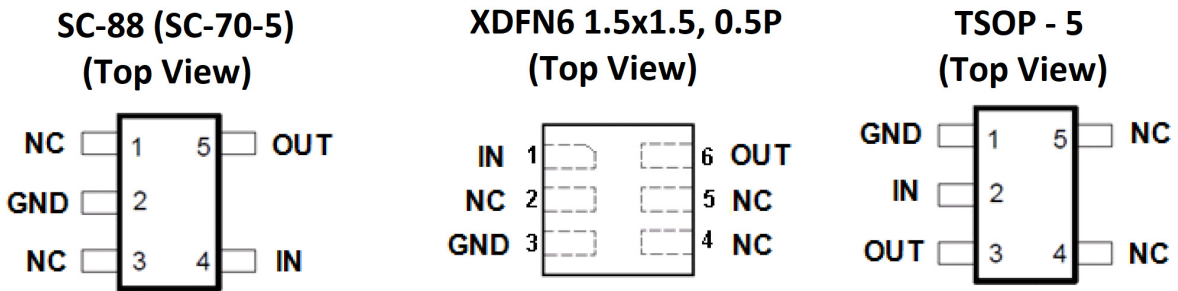

Figure 3. Pin Description

## PIN FUNCTION DESCRIPTION

Pin No.			Pin Name	Description
SC-70	XDFN6	TSOP-5		
5	6	3	OUT	Regulated output voltage pin. A small 0.47 $\mu$ F ceramic capacitor is needed from this pin to ground to assure stability.
1	2	4	N/C	No connection. This pin can be tied to ground to improve thermal dissipation or left disconnected.
2	3	1	GND	Power supply ground.
3	4	5	N/C	No connection. This pin can be tied to ground to improve thermal dissipation or left disconnected.
-	5	-	N/C	No connection. This pin can be tied to ground to improve thermal dissipation or left disconnected.
4	1	2	IN	Input pin. A small capacitor is needed from this pin to ground to assure stability.

# NCP715

## ABSOLUTE MAXIMUM RATINGS

Rating	Symbol	Value	Unit
Input Voltage (Note 1)	$V_{IN}$	-0.3 to 24	V
Output Voltage	$V_{OUT}$	-0.3 to 6	V
Output Short Circuit Duration	$t_{SC}$	Indefinite	s
Maximum Junction Temperature	$T_{J(MAX)}$	150	°C
Operating Ambient Temperature Range	$T_A$	-40 to 125	°C
Storage Temperature Range	$T_{STG}$	-55 to 150	°C
ESD Capability, Human Body Model (Note 2)	ESD <sub>HBM</sub>	2000	V
ESD Capability, Machine Model (Note 2)	ESD <sub>MM</sub>	200	V

Stresses exceeding those listed in the Maximum Ratings table may damage the device. If any of these limits are exceeded, device functionality should not be assumed, damage may occur and reliability may be affected.

1. Refer to ELECTRICAL CHARACTERISTICS and APPLICATION INFORMATION for Safe Operating Area.
2. This device series incorporates ESD protection and is tested by the following methods:
  - ESD Human Body Model tested per EIA/JESD22-A114
  - ESD Machine Model tested per EIA/JESD22-A115
  - ESD Charged Device Model tested per EIA/JESD22-C101E
  - Latch up Current Maximum Rating tested per JEDEC standard: JESD78.

## THERMAL CHARACTERISTICS

Rating	Symbol	Value	Unit
Thermal Characteristics, SC-70 Thermal Resistance, Junction-to-Air	$R_{\theta JA}$	390	°C/W
Thermal Characteristics, XDFN6 Thermal Resistance, Junction-to-Air	$R_{\theta JA}$	260	°C/W
Thermal Characteristics, TSOP-5 Thermal Resistance, Junction-to-Air	$R_{\theta JA}$	250	°C/W

# NCP715

## ELECTRICAL CHARACTERISTICS – Voltage Version 1.2 V

$-40^{\circ}\text{C} \leq T_J \leq 125^{\circ}\text{C}$ ;  $V_{IN} = 2.5\text{ V}$ ;  $I_{OUT} = 1\text{ mA}$ ,  $C_{IN} = C_{OUT} = 1.0\ \mu\text{F}$ , unless otherwise noted. Typical values are at  $T_J = +25^{\circ}\text{C}$ . (Note 5)

Parameter	Test Conditions	Symbol	Min	Typ	Max	Unit		
Operating Input Voltage	$I_{OUT} \leq 10\text{ mA}$	$V_{IN}$	2.5		24	V		
	$10\text{ mA} < I_{OUT} < 50\text{ mA}$		3.0		24			
Output Voltage Accuracy	$2.5\text{ V} < V_{IN} < 24\text{ V}$ , $0 < I_{OUT} \leq 10\text{ mA}$	$V_{OUT}$	1.164	1.2	1.236	V		
	$3.0\text{ V} < V_{IN} < 24\text{ V}$ , $0\text{ mA} < I_{OUT} < 50\text{ mA}$	$V_{OUT}$	1.164	1.2	1.236	V		
	$3.0\text{ V} < V_{IN} < 24\text{ V}$ , $1\text{ mA} < I_{OUT} < 50\text{ mA}$ , $-20^{\circ}\text{C} < T_J < 125^{\circ}\text{C}$ ;	$V_{OUT}$	1.176	1.2	1.224	V		
Line Regulation	$2.5\text{ V} \leq V_{IN} \leq 24\text{ V}$ , $I_{OUT} = 1\text{ mA}$	$\text{Reg}_{LINE}$		2		mV		
Load Regulation	$I_{OUT} = 0\text{ mA}$ to $50\text{ mA}$	$\text{Reg}_{LOAD}$		5		mV		
Dropout Voltage (Note 3)		$V_{DO}$			-	mV		
Maximum Output Current	(Note 6)	$I_{OUT}$	100		200	mA		
	$0 < I_{OUT} < 50\text{ mA}$ , $-40 < T_A < 85^{\circ}\text{C}$		$I_{GND}$		3.2		4.2	$\mu\text{A}$
	$0 < I_{OUT} < 50\text{ mA}$ , $V_{IN} = 24\text{ V}$						5.8	
Power Supply Rejection Ratio	$V_{IN} = 3.0\text{ V}$ , $V_{OUT} = 1.2\text{ V}$ $V_{PP} = 200\text{ mV}$ modulation $I_{OUT} = 1\text{ mA}$ , $C_{OUT} = 10\ \mu\text{F}$	$f = 100\text{ kHz}$	$\text{PSRR}$		60		dB	
Output Noise Voltage	$V_{OUT} = 1.2\text{ V}$ , $I_{OUT} = 50\text{ mA}$ $f = 200\text{ Hz}$ to $100\text{ kHz}$ , $C_{OUT} = 10\ \mu\text{F}$		$V_N$		65		$\mu\text{V}_{rms}$	
Thermal Shutdown Temperature (Note 4)	Temperature increasing from $T_J = +25^{\circ}\text{C}$		$T_{SD}$		170		$^{\circ}\text{C}$	
Thermal Shutdown Hysteresis (Note 4)	Temperature falling from $T_{SD}$		$T_{SDH}$		-	15	-	$^{\circ}\text{C}$

3. Not Characterized at  $V_{IN} = 3.0\text{ V}$ ,  $V_{OUT} = 1.2\text{ V}$ ,  $I_{OUT} = 50\text{ mA}$ .

4. Guaranteed by design and characterization.

5. Performance guaranteed over the indicated operating temperature range by design and/or characterization production tested at  $T_J = T_A = 25^{\circ}\text{C}$ . Low duty cycle pulse techniques are used during testing to maintain the junction temperature as close to ambient as possible.

6. Respect SOA.

# NCP715

## ELECTRICAL CHARACTERISTICS – Voltage Version 1.5 V

$-40^{\circ}\text{C} \leq T_J \leq 125^{\circ}\text{C}$ ;  $V_{IN} = 2.5\text{ V}$ ;  $I_{OUT} = 1\text{ mA}$ ,  $C_{IN} = C_{OUT} = 1.0\text{ }\mu\text{F}$ , unless otherwise noted. Typical values are at  $T_J = +25^{\circ}\text{C}$ . (Note 9)

Parameter	Test Conditions	Symbol	Min	Typ	Max	Unit
Operating Input Voltage	$I_{OUT} \leq 10\text{ mA}$	$V_{IN}$	2.5		24	V
	$10\text{ mA} < I_{OUT} < 50\text{ mA}$		3.0		24	
Output Voltage Accuracy	$2.5\text{ V} < V_{IN} < 24\text{ V}$ , $0 < I_{OUT} \leq 10\text{ mA}$	$V_{OUT}$	1.455	1.5	1.545	V
	$3.0\text{ V} < V_{IN} < 24\text{ V}$ , $0 < I_{OUT} < 50\text{ mA}$	$V_{OUT}$	1.455	1.5	1.545	V
	$3.0\text{ V} < V_{IN} < 24\text{ V}$ , $1\text{ mA} < I_{OUT} < 50\text{ mA}$ , $-20^{\circ}\text{C} < T_J < 125^{\circ}\text{C}$ ;	$V_{OUT}$	1.470	1.5	1.530	V
Line Regulation	$V_{OUT} + 1\text{ V} \leq V_{IN} \leq 24\text{ V}$ , $I_{OUT} = 1\text{ mA}$	$\text{Reg}_{LINE}$		2		mV
Load Regulation	$I_{OUT} = 0\text{ mA}$ to $50\text{ mA}$	$\text{Reg}_{LOAD}$		5		mV
Dropout Voltage (Note 7)		$V_{DO}$			-	mV
Maximum Output Current	(Note 10)	$I_{OUT}$	100		200	mA
Ground Current	$0 < I_{OUT} < 50\text{ mA}$ , $-40 < T_A < 85^{\circ}\text{C}$	$I_{GND}$		3.2	4.2	$\mu\text{A}$
	$0 < I_{OUT} < 50\text{ mA}$ , $V_{IN} = 24\text{ V}$				5.8	$\mu\text{A}$
Power Supply Rejection Ratio	$V_{IN} = 3.0\text{ V}$ , $V_{OUT} = 1.5\text{ V}$ $V_{PP} = 200\text{ mV}$ modulation $I_{OUT} = 1\text{ mA}$ , $C_{OUT} = 10\text{ }\mu\text{F}$	$f = 100\text{ kHz}$		56		dB
Output Noise Voltage	$V_{OUT} = 1.5\text{ V}$ , $I_{OUT} = 50\text{ mA}$ $f = 200\text{ Hz}$ to $100\text{ kHz}$ , $C_{OUT} = 10\text{ }\mu\text{F}$	$V_N$		75		$\mu\text{V}_{rms}$
Thermal Shutdown Temperature (Note 8)	Temperature increasing from $T_J = +25^{\circ}\text{C}$	$T_{SD}$		170		$^{\circ}\text{C}$
Thermal Shutdown Hysteresis (Note 8)	Temperature falling from $T_{SD}$	$T_{SDH}$	-	15	-	$^{\circ}\text{C}$

7. Not Characterized at  $V_{IN} = 3.0\text{ V}$ ,  $V_{OUT} = 1.5\text{ V}$ ,  $I_{OUT} = 50\text{ mA}$ .

8. Guaranteed by design and characterization.

9. Performance guaranteed over the indicated operating temperature range by design and/or characterization production tested at

$T_J = T_A = 25^{\circ}\text{C}$ . Low duty cycle pulse techniques are used during testing to maintain the junction temperature as close to ambient as possible.

10. Respect SOA.

# NCP715

## ELECTRICAL CHARACTERISTICS – Voltage Version 1.8 V

$-40^{\circ}\text{C} \leq T_J \leq 125^{\circ}\text{C}$ ;  $V_{IN} = 2.8\text{V}$ ;  $I_{OUT} = 1\text{ mA}$ ,  $C_{IN} = C_{OUT} = 1.0\ \mu\text{F}$ , unless otherwise noted. Typical values are at  $T_J = +25^{\circ}\text{C}$ . (Note 13)

Parameter	Test Conditions	Symbol	Min	Typ	Max	Unit
Operating Input Voltage	$I_{OUT} \leq 10\text{ mA}$	$V_{IN}$	2.8		24	V
	$10\text{ mA} < I_{OUT} < 50\text{ mA}$		3.0		24	
Output Voltage Accuracy	$2.8\text{ V} < V_{IN} < 24\text{ V}$ , $0 < I_{OUT} < 10\text{ mA}$	$V_{OUT}$	1.746	1.8	1.854	V
	$3.0\text{ V} < V_{IN} < 24\text{ V}$ , $1\text{ mA} < I_{OUT} < 50\text{ mA}$ , $-20^{\circ}\text{C} < T_J < 125^{\circ}\text{C}$ ;	$V_{OUT}$	1.764	1.8	1.836	V
Line Regulation	$3\text{ V} \leq V_{IN} \leq 24\text{ V}$ , $I_{OUT} = 1\text{ mA}$	$\text{Reg}_{LINE}$		3		mV
Load Regulation	$I_{OUT} = 0\text{ mA to } 50\text{ mA}$	$\text{Reg}_{LOAD}$		10		mV
Dropout Voltage (Note 11)		$V_{DO}$				mV
Maximum Output Current	(Note 14)	$I_{OUT}$	100		200	mA
Ground Current	$0 < I_{OUT} < 50\text{ mA}$ , $-40 < T_A < 85^{\circ}\text{C}$	$I_{GND}$		3.2	4.2	$\mu\text{A}$
	$0 < I_{OUT} < 50\text{ mA}$ , $V_{IN} = 24\text{ V}$				5.8	$\mu\text{A}$
Power Supply Rejection Ratio	$V_{IN} = 3.0\text{ V}$ , $V_{OUT} = 1.8\text{ V}$ $V_{PP} = 200\text{ mV modulation}$ $I_{OUT} = 1\text{ mA}$ , $C_{OUT} = 10\ \mu\text{F}$	$f = 100\text{ kHz}$		60		dB
Output Noise Voltage	$V_{OUT} = 1.8\text{ V}$ , $I_{OUT} = 50\text{ mA}$ $f = 200\text{ Hz to } 100\text{ kHz}$ , $C_{OUT} = 10\ \mu\text{F}$	$V_N$		95		$\mu\text{V}_{rms}$
Thermal Shutdown Temperature (Note 12)	Temperature increasing from $T_J = +25^{\circ}\text{C}$	$T_{SD}$		170		$^{\circ}\text{C}$
Thermal Shutdown Hysteresis (Note 12)	Temperature falling from $T_{SD}$	$T_{SDH}$	–	15	–	$^{\circ}\text{C}$

11. Not characterized at  $V_{IN} = 3.0\text{ V}$ ,  $V_{OUT} = 1.8\text{ V}$ ,  $I_{OUT} = 50\text{ mA}$

12. Guaranteed by design and characterization.

13. Performance guaranteed over the indicated operating temperature range by design and/or characterization production tested at  $T_J = T_A = 25^{\circ}\text{C}$ . Low duty cycle pulse techniques are used during testing to maintain the junction temperature as close to ambient as possible.

14. Respect SOA.

# NCP715

## ELECTRICAL CHARACTERISTICS – Voltage Version 2.5 V

$-40^{\circ}\text{C} \leq T_J \leq 125^{\circ}\text{C}$ ;  $V_{IN} = 3.5\text{ V}$ ;  $I_{OUT} = 1\text{ mA}$ ,  $C_{IN} = C_{OUT} = 1.0\text{ }\mu\text{F}$ , unless otherwise noted. Typical values are at  $T_J = +25^{\circ}\text{C}$ . (Note 17)

Parameter	Test Conditions	Symbol	Min	Typ	Max	Unit
Operating Input Voltage	$0 < I_{OUT} < 50\text{ mA}$	$V_{IN}$	3.5		24	V
Output Voltage Accuracy	$3.5\text{ V} < V_{IN} < 24\text{ V}$ , $0 < I_{OUT} < 50\text{ mA}$	$V_{OUT}$	2.45	2.5	2.55	V
Line Regulation	$V_{OUT} + 1\text{ V} \leq V_{IN} \leq 24\text{ V}$ , $I_{OUT} = 1\text{ mA}$	Reg <sub>LINE</sub>		3		mV
Load Regulation	$I_{OUT} = 0\text{ mA}$ to $50\text{ mA}$	Reg <sub>LOAD</sub>		10		mV
Dropout Voltage (Note 15)	$V_{DO} = V_{IN} - (V_{OUT(NOM)} - 75\text{ mV})$ $I_{OUT} = 50\text{ mA}$	$V_{DO}$		260	450	mV
Maximum Output Current	(Note 18)	$I_{OUT}$	100		200	mA
Ground Current	$0 < I_{OUT} < 50\text{ mA}$ , $-40 < T_A < 85^{\circ}\text{C}$	$I_{GND}$		3.2	4.2	$\mu\text{A}$
	$0 < I_{OUT} < 50\text{ mA}$ , $V_{IN} = 24\text{ V}$				5.8	$\mu\text{A}$
Power Supply Rejection Ratio	$V_{IN} = 3.5\text{ V}$ , $V_{OUT} = 2.5\text{ V}$ $V_{PP} = 200\text{ mV}$ modulation $I_{OUT} = 1\text{ mA}$ , $C_{OUT} = 10\text{ }\mu\text{F}$	$f = 100\text{ kHz}$	PSRR	60		dB
Output Noise Voltage	$V_{OUT} = 2.5\text{ V}$ , $I_{OUT} = 50\text{ mA}$ $f = 200\text{ Hz}$ to $100\text{ kHz}$ , $C_{OUT} = 10\text{ }\mu\text{F}$	$V_N$		115		$\mu\text{V}_{rms}$
Thermal Shutdown Temperature (Note 16)	Temperature increasing from $T_J = +25^{\circ}\text{C}$	$T_{SD}$		170		$^{\circ}\text{C}$
Thermal Shutdown Hysteresis (Note 16)	Temperature falling from $T_{SD}$	$T_{SDH}$	–	15	–	$^{\circ}\text{C}$

15. Characterized when  $V_{OUT}$  falls 75 mV below the regulated voltage and only for devices with  $V_{OUT} = 2.5\text{ V}$ .

16. Guaranteed by design and characterization.

17. Performance guaranteed over the indicated operating temperature range by design and/or characterization production tested at

$T_J = T_A = 25^{\circ}\text{C}$ . Low duty cycle pulse techniques are used during testing to maintain the junction temperature as close to ambient as possible.

18. Respect SOA.

# NCP715

## ELECTRICAL CHARACTERISTICS – Voltage Version 3.0 V

$-40^{\circ}\text{C} \leq T_J \leq 125^{\circ}\text{C}$ ;  $V_{IN} = 4.0\text{ V}$ ;  $I_{OUT} = 1\text{ mA}$ ,  $C_{IN} = C_{OUT} = 1.0\text{ }\mu\text{F}$ , unless otherwise noted. Typical values are at  $T_J = +25^{\circ}\text{C}$ . (Note 21)

Parameter	Test Conditions	Symbol	Min	Typ	Max	Unit
Operating Input Voltage	$0 < I_{OUT} < 50\text{ mA}$	$V_{IN}$	4.0		24	V
Output Voltage Accuracy	$4.0\text{ V} < V_{IN} < 24\text{ V}$ , $0 < I_{OUT} < 50\text{ mA}$	$V_{OUT}$	2.94	3.0	3.06	V
Line Regulation	$V_{OUT} + 1\text{ V} \leq V_{IN} \leq 24\text{ V}$ , $I_{OUT} = 1\text{ mA}$	$\text{Reg}_{LINE}$		3		mV
Load Regulation	$I_{OUT} = 0\text{ mA to } 50\text{ mA}$	$\text{Reg}_{LOAD}$		10		mV
Dropout voltage (Note 19)	$V_{DO} = V_{IN} - (V_{OUT(NOM)} - 90\text{ mV})$ $I_{OUT} = 50\text{ mA}$	$V_{DO}$		250	400	mV
Maximum Output Current	(Note 22)	$I_{OUT}$	100		200	mA
Ground current	$0 < I_{OUT} < 50\text{ mA}$ , $-40 < T_A < 85^{\circ}\text{C}$	$I_{GND}$		3.2	4.2	$\mu\text{A}$
	$0 < I_{OUT} < 50\text{ mA}$ , $V_{IN} = 24\text{ V}$				5.8	$\mu\text{A}$
Power Supply Rejection Ratio	$V_{IN} = 4.0\text{ V}$ , $V_{OUT} = 3.0\text{ V}$ $V_{PP} = 100\text{ mV modulation}$ $I_{OUT} = 1\text{ mA}$ , $C_{OUT} = 10\text{ }\mu\text{F}$	$f = 100\text{ kHz}$	$\text{PSRR}$		60	dB
Output Noise Voltage	$V_{OUT} = 3\text{ V}$ , $I_{OUT} = 50\text{ mA}$ , $f = 200\text{ Hz to } 100\text{ kHz}$ , $C_{OUT} = 10\text{ }\mu\text{F}$	$V_N$		135		$\mu\text{V}_{rms}$
Thermal Shutdown Temperature (Note 20)	Temperature increasing from $T_J = +25^{\circ}\text{C}$	$T_{SD}$		170		$^{\circ}\text{C}$
Thermal Shutdown Hysteresis (Note 20)	Temperature falling from $T_{SD}$	$T_{SDH}$	-	25	-	$^{\circ}\text{C}$

19. Characterized when  $V_{OUT}$  falls 90 mV below the regulated voltage and only for devices with  $V_{OUT} = 3.0\text{ V}$

20. Guaranteed by design and characterization.

21. Performance guaranteed over the indicated operating temperature range by design and/or characterization production tested

at  $T_J = T_A = 25^{\circ}\text{C}$ . Low duty cycle pulse techniques are used during testing to maintain the junction temperature as close to ambient as possible.

22. Respect SOA

# NCP715

## ELECTRICAL CHARACTERISTICS – Voltage Version 3.3 V

$-40^{\circ}\text{C} \leq T_J \leq 125^{\circ}\text{C}$ ;  $V_{IN} = 4.3\text{ V}$ ;  $I_{OUT} = 1\text{ mA}$ ,  $C_{IN} = C_{OUT} = 1.0\text{ }\mu\text{F}$ , unless otherwise noted. Typical values are at  $T_J = +25^{\circ}\text{C}$ . (Note 25)

Parameter	Test Conditions	Symbol	Min	Typ	Max	Unit	
Operating Input Voltage	$0 < I_{OUT} < 50\text{ mA}$	$V_{IN}$	4.3		24	V	
Output Voltage Accuracy	$4.3\text{ V} < V_{IN} < 24\text{ V}$ , $0 < I_{OUT} < 50\text{ mA}$	$V_{OUT}$	3.234	3.3	3.366	V	
Line Regulation	$V_{OUT} + 1\text{ V} \leq V_{IN} \leq 24\text{ V}$ , $I_{OUT} = 1\text{ mA}$	Reg <sub>LINE</sub>		3	10	mV	
Load Regulation	$I_{OUT} = 0\text{ mA}$ to $50\text{ mA}$	Reg <sub>LOAD</sub>		10		mV	
Dropout Voltage (Note 23)	$V_{DO} = V_{IN} - (V_{OUT(NOM)} - 99\text{ mV})$ $I_{OUT} = 50\text{ mA}$	$V_{DO}$		230	350	mV	
Maximum Output Current	(Note 26)	$I_{OUT}$	100		200	mA	
Ground Current	$0 < I_{OUT} < 50\text{ mA}$ , $-40 < T_A < 85^{\circ}\text{C}$	$I_{GND}$		3.2	4.2	$\mu\text{A}$	
	$0 < I_{OUT} < 50\text{ mA}$ , $V_{IN} = 24\text{ V}$				5.8	$\mu\text{A}$	
Power Supply Rejection Ratio	$V_{IN} = 4.3\text{ V}$ , $V_{OUT} = 3.3\text{ V}$ $V_{PP} = 200\text{ mV}$ modulation $I_{OUT} = 1\text{ mA}$ , $C_{OUT} = 10\text{ }\mu\text{F}$	$f = 100\text{ kHz}$	PSRR		60		dB
Output Noise Voltage	$V_{OUT} = 4.3\text{ V}$ , $I_{OUT} = 50\text{ mA}$ $f = 200\text{ Hz}$ to $100\text{ kHz}$ , $C_{OUT} = 10\text{ }\mu\text{F}$	$V_N$		140		$\mu\text{V}_{rms}$	
Thermal Shutdown Temperature (Note 24)	Temperature increasing from $T_J = +25^{\circ}\text{C}$	$T_{SD}$		170		$^{\circ}\text{C}$	
Thermal Shutdown Hysteresis (Note 24)	Temperature falling from $T_{SD}$	$T_{SDH}$	–	15	–	$^{\circ}\text{C}$	

23. Characterized when  $V_{OUT}$  falls 99 mV below the regulated voltage and only for devices with  $V_{OUT} = 3.3\text{ V}$ .

24. Guaranteed by design and characterization.

25. Performance guaranteed over the indicated operating temperature range by design and/or characterization production tested at  $T_J = T_A = 25^{\circ}\text{C}$ . Low duty cycle pulse techniques are used during testing to maintain the junction temperature as close to ambient as possible.

26. Respect SOA.

# NCP715

## ELECTRICAL CHARACTERISTICS – Voltage Version 5.0 V

$-40^{\circ}\text{C} \leq T_J \leq 125^{\circ}\text{C}$ ;  $V_{IN} = 6.0\text{ V}$ ;  $I_{OUT} = 1\text{ mA}$ ,  $C_{IN} = C_{OUT} = 1\text{ }\mu\text{F}$ , unless otherwise noted. Typical values are at  $T_J = +25^{\circ}\text{C}$ . (Note 29)

Parameter	Test Conditions	Symbol	Min	Typ	Max	Unit
Operating Input Voltage	$0 < I_{OUT} < 50\text{ mA}$	$V_{IN}$	6.0		24	V
Output Voltage Accuracy	$6.0\text{V} < V_{IN} < 24\text{V}$ , $0 < I_{OUT} < 50\text{ mA}$	$V_{OUT}$	4.9	5.0	5.1	V
Line Regulation	$V_{OUT} + 1\text{ V} \leq V_{IN} \leq 24\text{ V}$ , $I_{OUT} = 1\text{ mA}$	$Reg_{LINE}$		3	10	mV
Load Regulation	$I_{OUT} = 0\text{ mA}$ to $50\text{ mA}$	$Reg_{LOAD}$		10	30	mV
Dropout Voltage (Note 27)	$V_{DO} = V_{IN} - (V_{OUT(NOM)} - 150\text{ mV})$ $I_{OUT} = 50\text{ mA}$	$V_{DO}$		230	350	mV
Maximum Output Current	(Note 30)	$I_{OUT}$	90		200	mA
Ground Current	$0 < I_{OUT} < 50\text{ mA}$ , $-40 < T_A < 85^{\circ}\text{C}$	$I_{GND}$		3.2	4.2	$\mu\text{A}$
	$0 < I_{OUT} < 50\text{ mA}$ , $V_{IN} = 24\text{ V}$				5.8	$\mu\text{A}$
Power Supply Rejection Ratio	$V_{IN} = 6.0\text{ V}$ , $V_{OUT} = 5.0\text{ V}$ $V_{PP} = 200\text{ mV}$ modulation $I_{OUT} = 1\text{ mA}$ , $C_{OUT} = 10\text{ }\mu\text{F}$	$f = 100\text{ kHz}$		56		dB
Output Noise Voltage	$V_{OUT} = 5.0\text{ V}$ , $I_{OUT} = 50\text{ mA}$ $f = 200\text{ Hz}$ to $100\text{ kHz}$ , $C_{OUT} = 10\text{ }\mu\text{F}$	$V_N$		190		$\mu\text{V}_{rms}$
Thermal Shutdown Temperature (Note 28)	Temperature increasing from $T_J = +25^{\circ}\text{C}$	$T_{SD}$		170		$^{\circ}\text{C}$
Thermal Shutdown Hysteresis (Note 28)	Temperature falling from $T_{SD}$	$T_{SDH}$	–	15	–	$^{\circ}\text{C}$

27. Characterized when  $V_{OUT}$  falls 150 mV below the regulated voltage and only for devices with  $V_{OUT} = 5.0\text{ V}$ .

28. Guaranteed by design and characterization.

29. Performance guaranteed over the indicated operating temperature range by design and/or characterization production tested at  $T_J = T_A = 25^{\circ}\text{C}$ . Low duty cycle pulse techniques are used during testing to maintain the junction temperature as close to ambient as possible.

30. Respect SOA.

# NCP715

## ELECTRICAL CHARACTERISTICS – Voltage Version 5.3 V

$-40^{\circ}\text{C} \leq T_J \leq 125^{\circ}\text{C}$ ;  $V_{IN} = 6.3\text{ V}$ ;  $I_{OUT} = 1\text{ mA}$ ,  $C_{IN} = C_{OUT} = 1\text{ }\mu\text{F}$ , unless otherwise noted. Typical values are at  $T_J = +25^{\circ}\text{C}$ . (Note 33)

Parameter	Test Conditions	Symbol	Min	Typ	Max	Unit
Operating Input Voltage	$0 < I_{OUT} < 50\text{ mA}$	$V_{IN}$	6.3		24	V
Output Voltage Accuracy	$6.3\text{V} < V_{IN} < 24\text{V}$ , $0.1\text{ mA} < I_{OUT} < 50\text{ mA}$	$V_{OUT}$	5.194	5.3	5.406	V
Line Regulation	$V_{OUT} + 1\text{ V} \leq V_{IN} \leq 24\text{ V}$ , $I_{OUT} = 1\text{ mA}$	Reg <sub>LINE</sub>		20	60	mV
Load Regulation	$I_{OUT} = 0.1\text{ mA}$ to $50\text{ mA}$	Reg <sub>LOAD</sub>		20		mV
Dropout Voltage (Note 31)	$V_{DO} = V_{IN} - (V_{OUT(NOM)} - 159\text{ mV})$ $I_{OUT} = 50\text{ mA}$	$V_{DO}$		230	350	mV
Maximum Output Current	(Note 34)	$I_{OUT}$	90		200	mA
Ground Current	$0 < I_{OUT} < 50\text{ mA}$ , $-40 < T_A < 85^{\circ}\text{C}$	$I_{GND}$		3.2	4.2	$\mu\text{A}$
	$0 < I_{OUT} < 50\text{ mA}$ , $V_{IN} = 24\text{ V}$				5.8	$\mu\text{A}$
Power Supply Rejection Ratio	$V_{IN} = 6.3\text{ V}$ , $V_{OUT} = 5.3\text{ V}$ $V_{PP} = 200\text{ mV}$ modulation $I_{OUT} = 1\text{ mA}$ , $C_{OUT} = 10\text{ }\mu\text{F}$	$f = 100\text{ kHz}$	PSRR	55		dB
Output Noise Voltage	$V_{OUT} = 5.3\text{ V}$ , $I_{OUT} = 50\text{ mA}$ $f = 200\text{ Hz}$ to $100\text{ kHz}$ , $C_{OUT} = 10\text{ }\mu\text{F}$	$V_N$		195		$\mu\text{V}_{rms}$
Thermal Shutdown Temperature (Note 32)	Temperature increasing from $T_J = +25^{\circ}\text{C}$	$T_{SD}$		170		$^{\circ}\text{C}$
Thermal Shutdown Hysteresis (Note 32)	Temperature falling from $T_{SD}$	$T_{SDH}$	–	15	–	$^{\circ}\text{C}$

31. Characterized when  $V_{OUT}$  falls 159 mV below the regulated voltage and only for devices with  $V_{OUT} = 5.3\text{ V}$ .

32. Guaranteed by design and characterization.

33. Performance guaranteed over the indicated operating temperature range by design and/or characterization production tested at  $T_J = T_A = 25^{\circ}\text{C}$ . Low duty cycle pulse techniques are used during testing to maintain the junction temperature as close to ambient as possible.

34. Respect SOA.

# NCP715

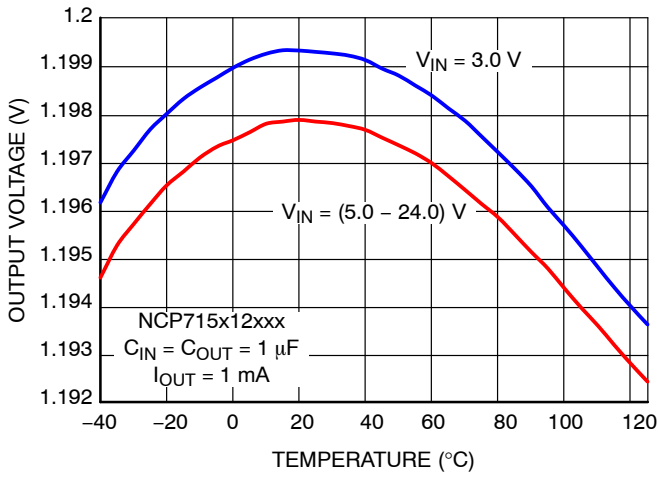

Figure 4. Output Voltage vs. Temperature

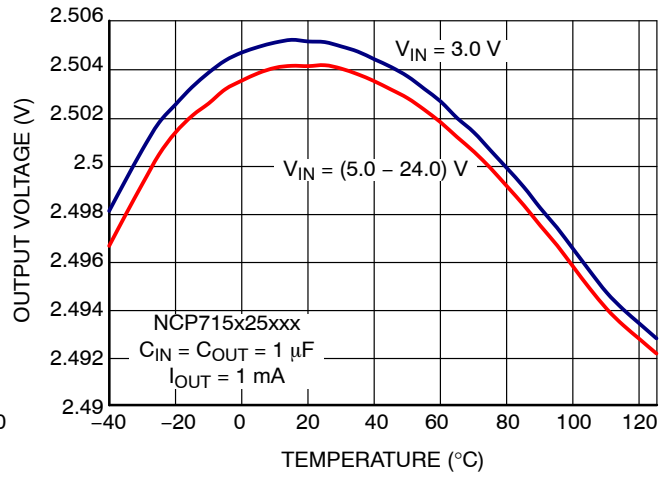

Figure 5. Output Voltage vs. Temperature

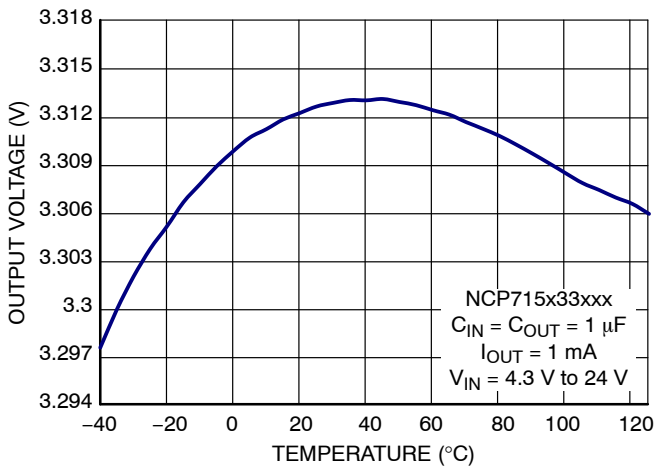

Figure 6. Output Voltage vs. Temperature

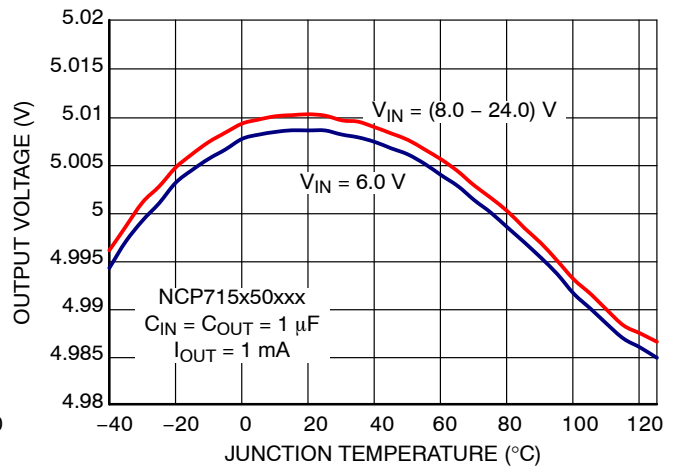

Figure 7. Output Voltage vs. Temperature

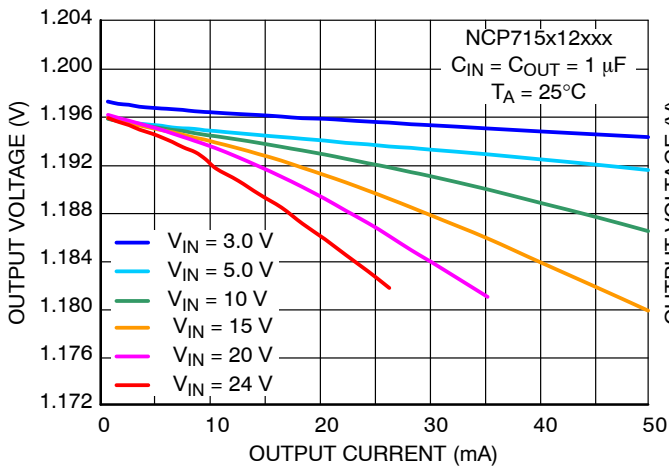

Figure 8. Output Voltage vs. Output Current

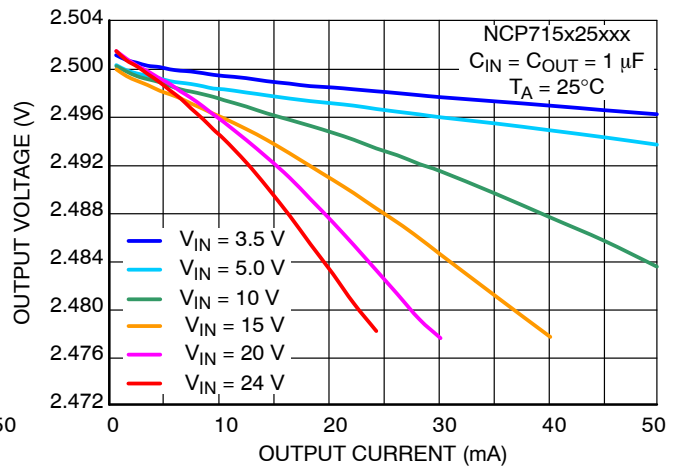

Figure 9. Output Voltage vs. Output Current

# NCP715

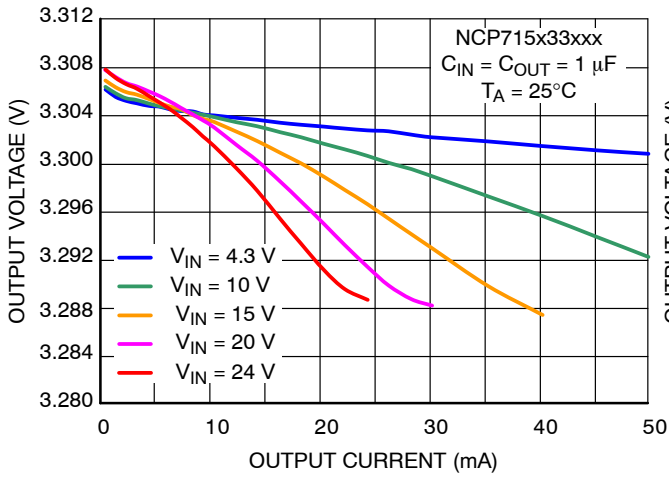

Figure 10. Output Voltage vs. Output Current

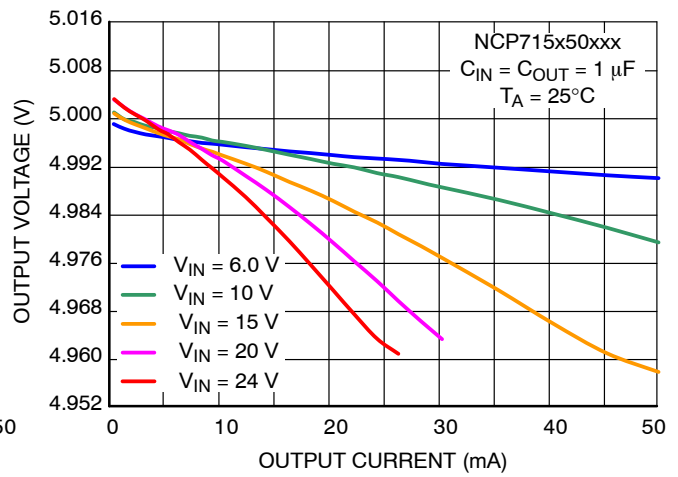

Figure 11. Output Voltage vs. Output Current

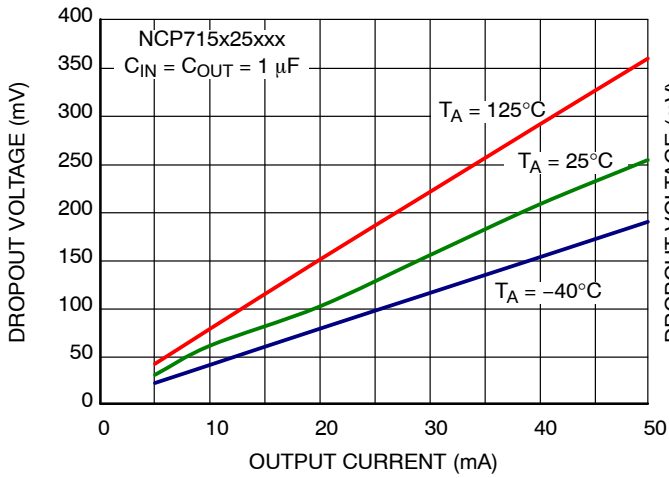

Figure 12. Dropout Voltage vs. Output Current

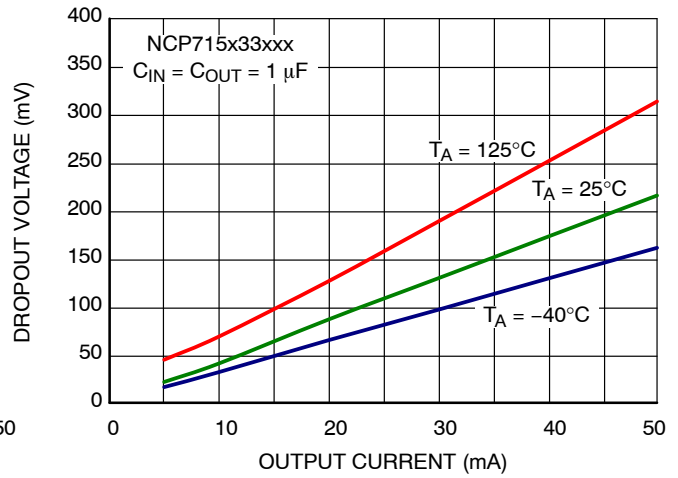

Figure 13. Dropout Voltage vs. Output Current

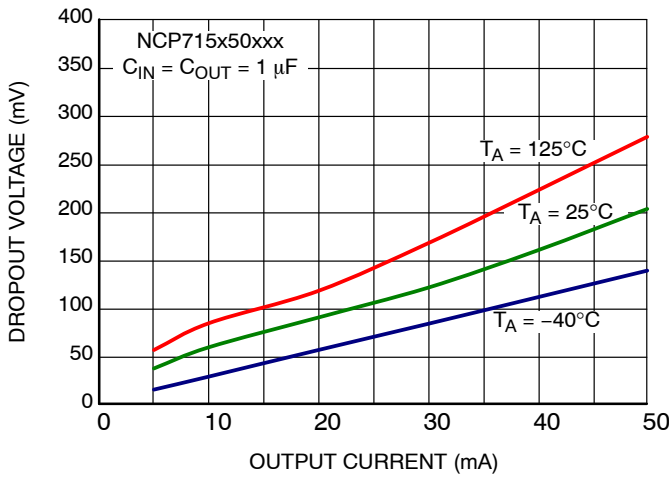

Figure 14. Dropout Voltage vs. Output Current

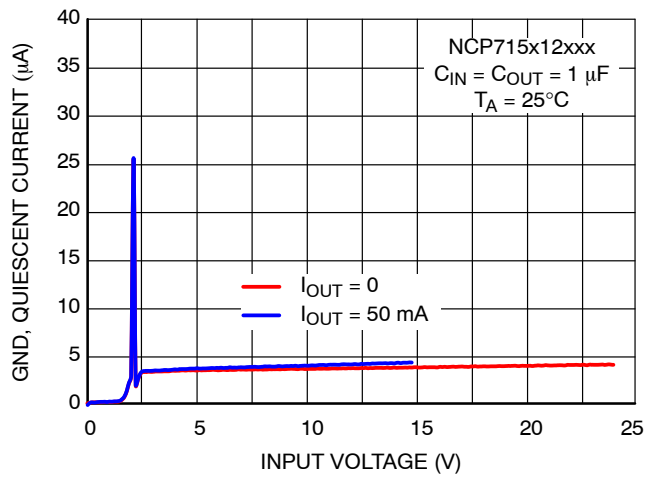

Figure 15. Ground Current vs. Input Voltage

# NCP715

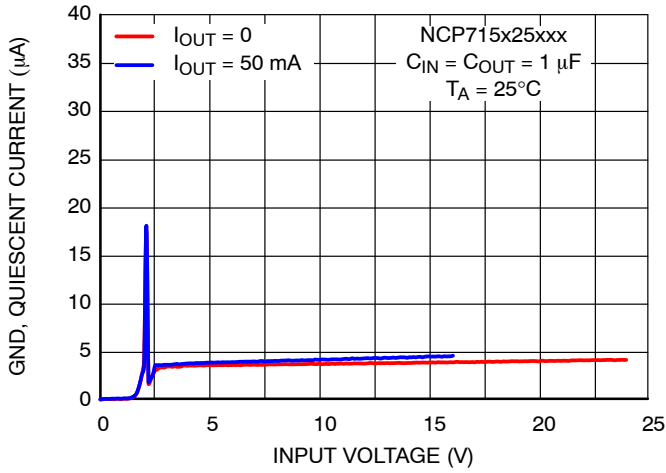

Figure 16. Ground Current vs. Input Voltage

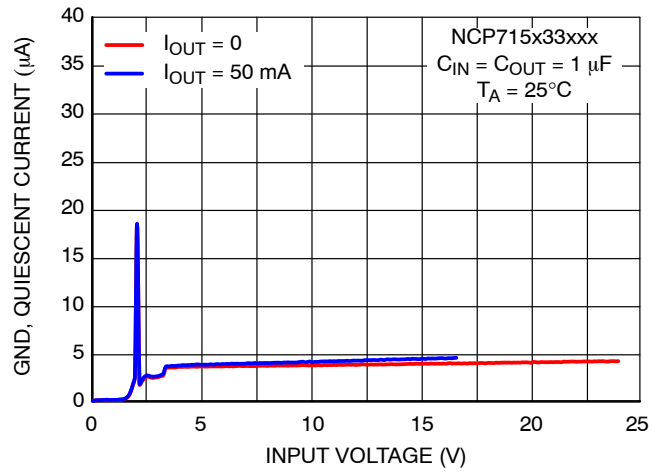

Figure 17. Ground Current vs. Input Voltage

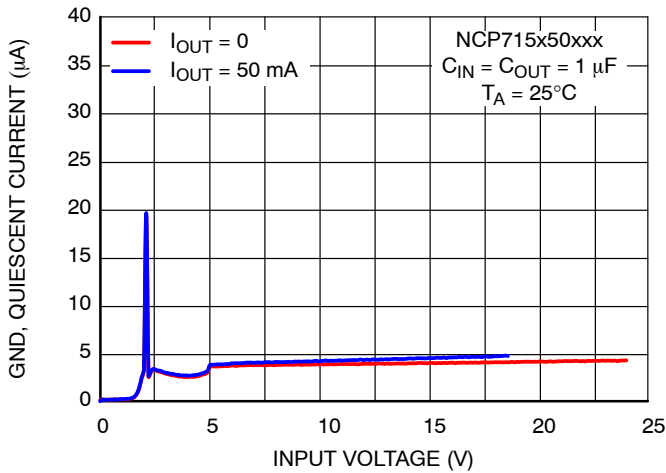

Figure 18. Ground Current vs. Input Voltage

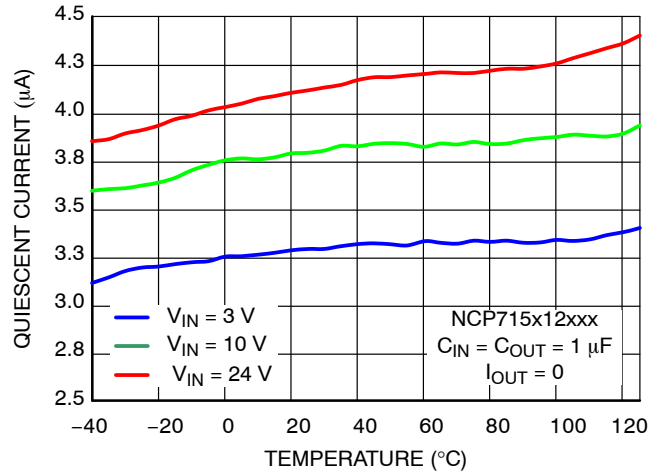

Figure 19. Quiescent Current vs. Temperature

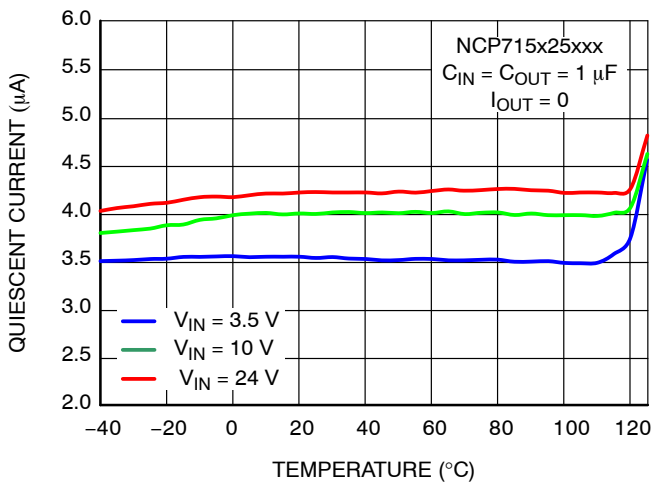

Figure 20. Quiescent Current vs. Temperature

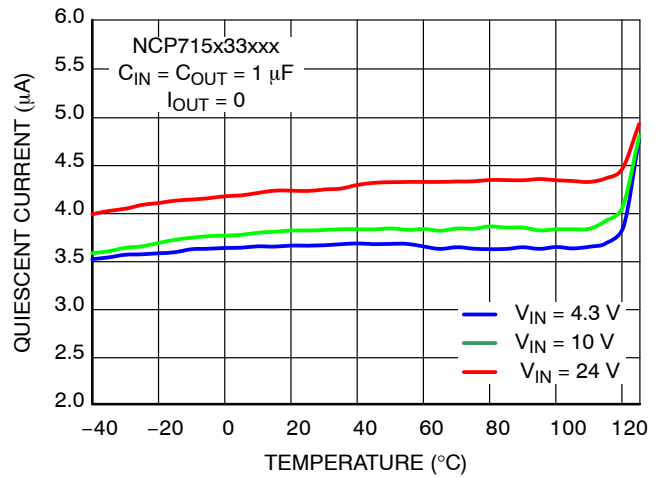

Figure 21. Quiescent Current vs. Temperature

# NCP715

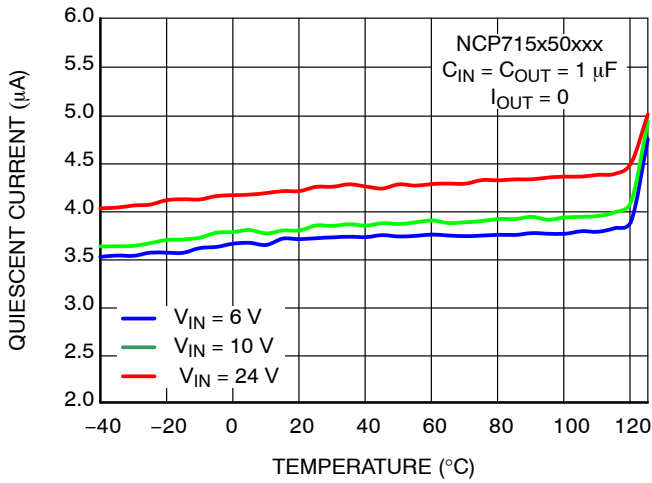

Figure 22. Quiescent Current vs. Temperature

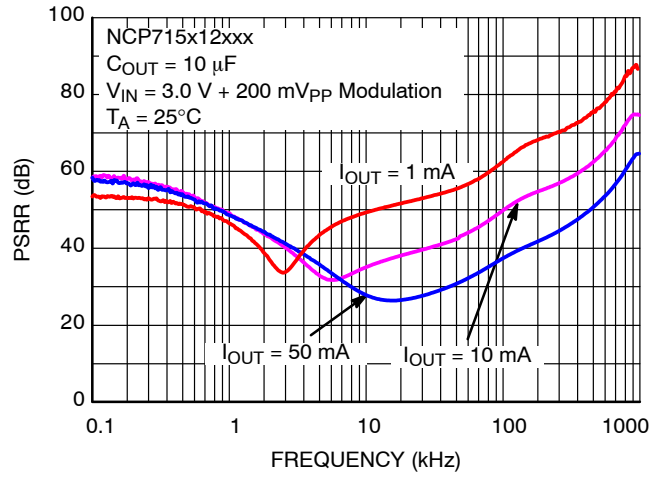

Figure 23. PSRR vs. Frequency

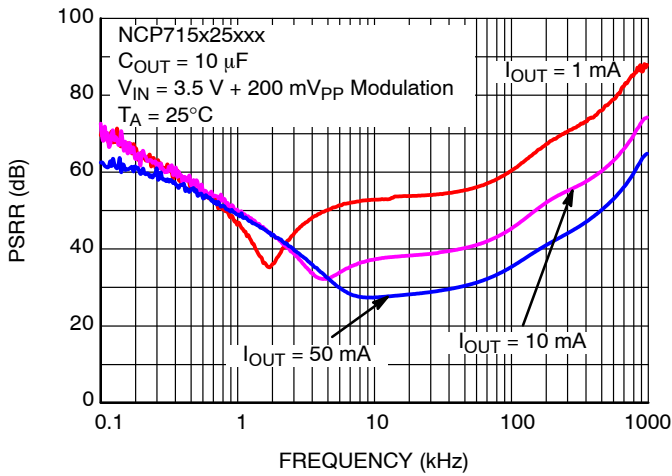

Figure 24. PSRR vs. Frequency

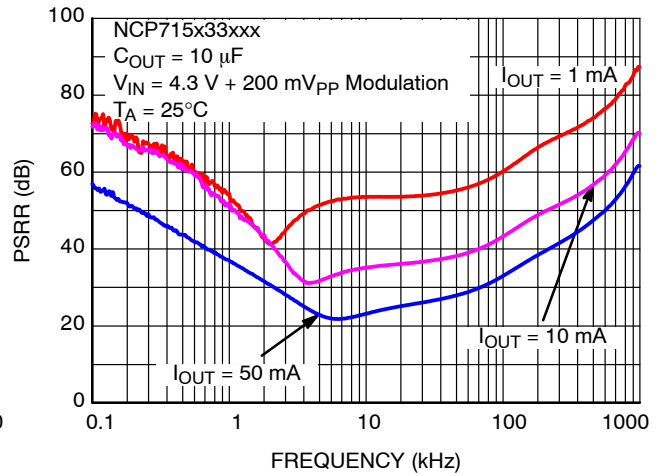

Figure 25. PSRR vs. Frequency

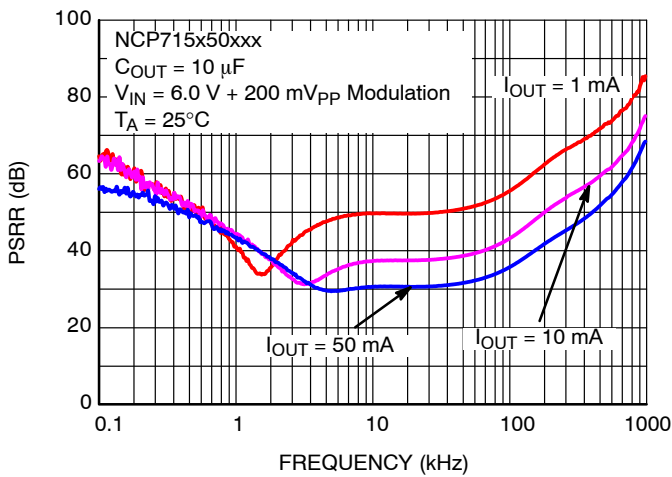

Figure 26. PSRR vs. Frequency

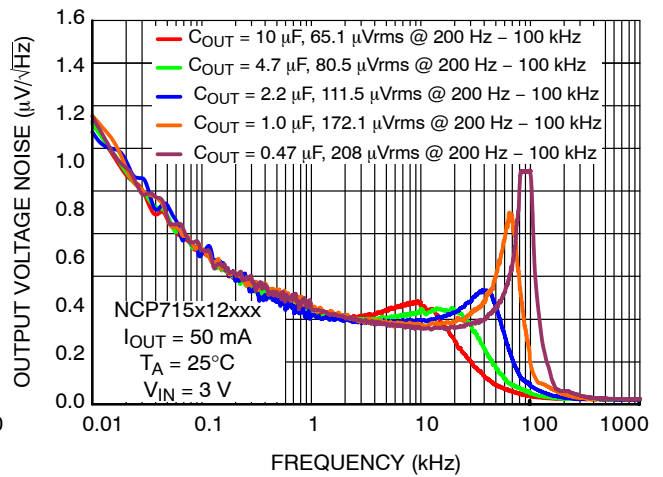

Figure 27. Output Spectral Noise Density vs. Frequency

# NCP715

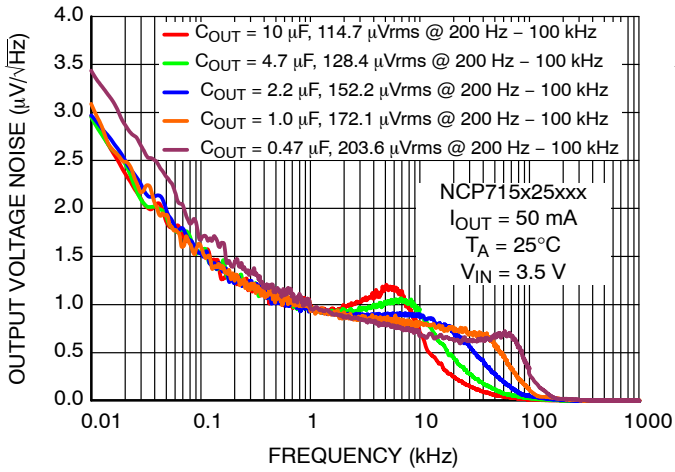

Figure 28. Output Spectral Noise Density vs. Frequency

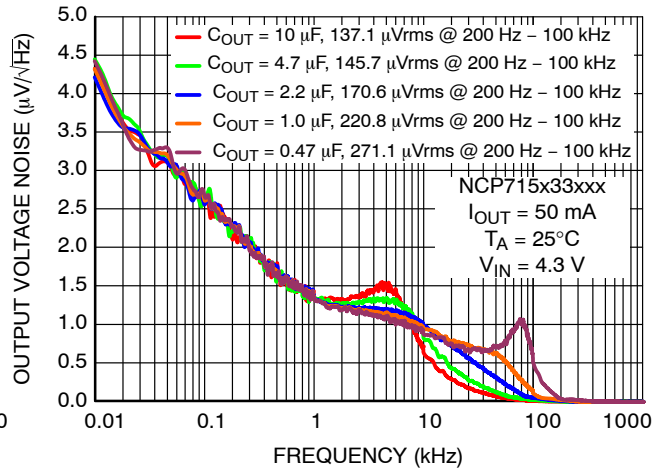

Figure 29. Output Spectral Noise Density vs. Frequency

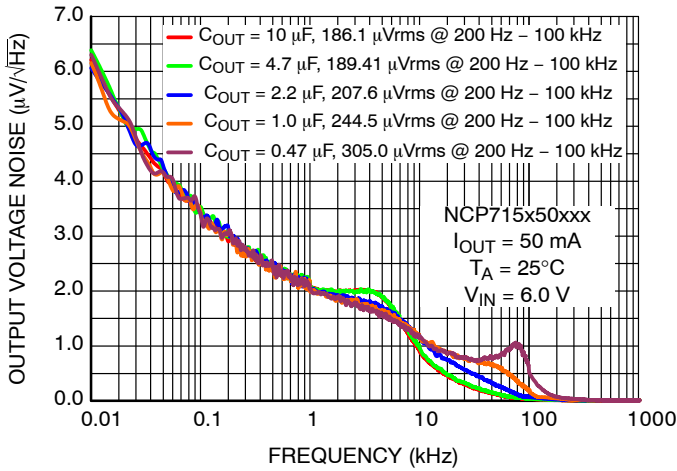

Figure 30. Output Spectral Noise Density vs. Frequency

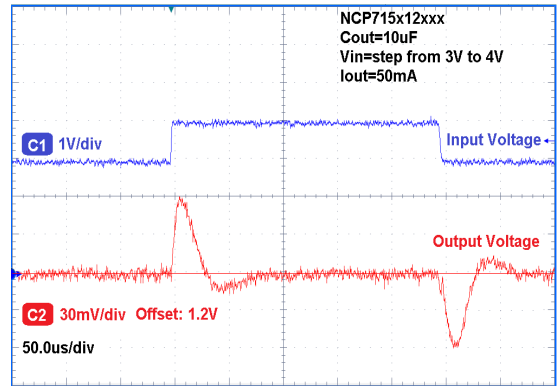

Figure 31. Line Transient Response

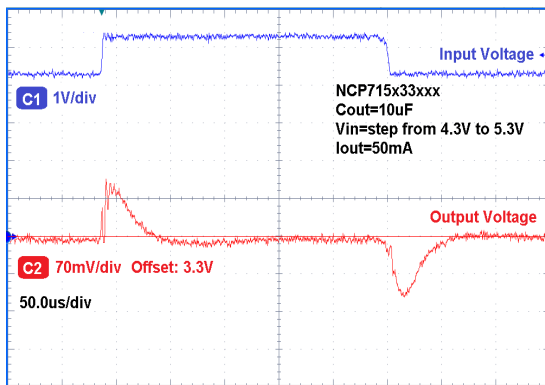

Figure 32. Line Transient Response

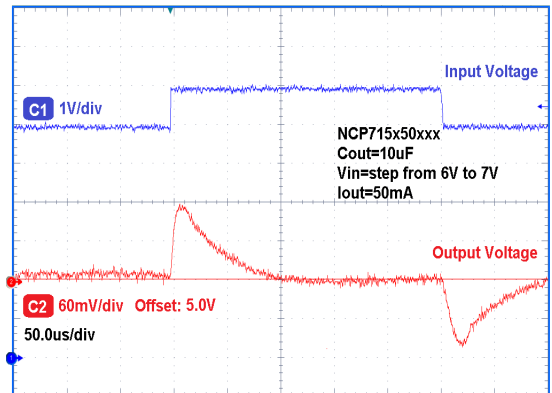

Figure 33. Line Transient Response

# NCP715

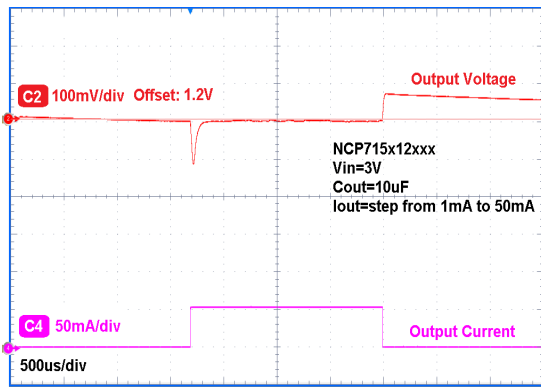

Figure 34. Load Transient Response

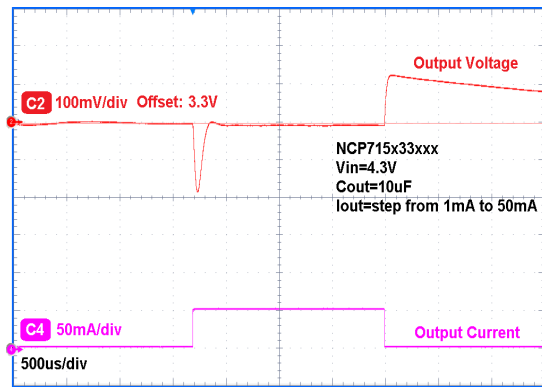

Figure 35. Load Transient Response

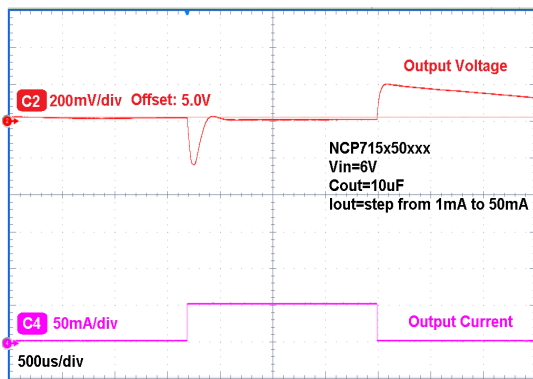

Figure 36. Load Transient Response

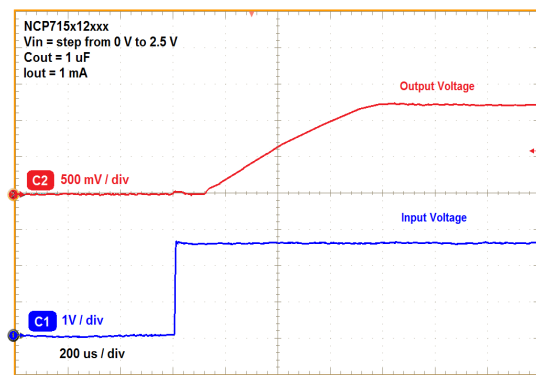

Figure 37. Input Voltage Turn-On Response

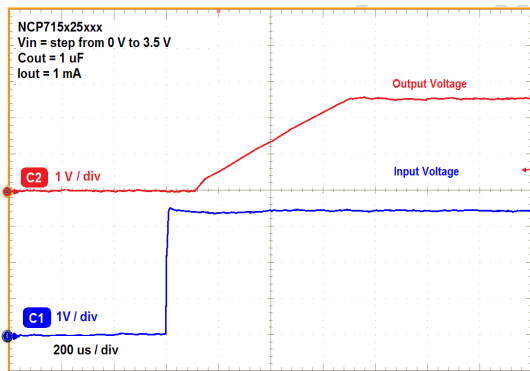

Figure 38. Input Voltage Turn-On Response

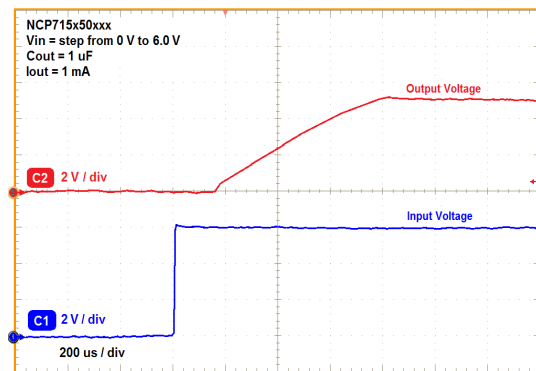

Figure 39. Input Voltage Turn-On Response

# NCP715

## APPLICATIONS INFORMATION

The NCP715 is the member of new family of Wide Input Voltage Range Low Dropout Regulators which delivers Ultra Low Ground Current consumption, Good Noise and Power Supply Rejection Ratio Performance.

### Input Decoupling (C<sub>IN</sub>)

It is recommended to connect at least 0.1 μF Ceramic X5R or X7R capacitor between IN and GND pin of the device. This capacitor will provide a low impedance path for any unwanted AC signals or Noise superimposed onto constant Input Voltage. The good input capacitor will limit the influence of input trace inductances and source resistance during sudden load current changes.

Higher capacitance and lower ESR Capacitors will improve the overall line transient response.

### Output Decoupling (C<sub>OUT</sub>)

The NCP715 does not require a minimum Equivalent Series Resistance (ESR) for the output capacitor. The device is designed to be stable with standard ceramics capacitors with values of 0.47 μF or greater up to 10 μF. The X5R and X7R types have the lowest capacitance variations over temperature thus they are recommended.

### Power Dissipation and Heat sinking

The maximum power dissipation supported by the device is dependent upon board design and layout. Mounting pad configuration on the PCB, the board material, and the

ambient temperature affect the rate of junction temperature rise for the part. The maximum power dissipation the NCP715 can handle is given by:

$$P_{D(MAX)} = \frac{[T_{J(MAX)} - T_A]}{R_{\theta JA}} \quad (\text{eq. 1})$$

The power dissipated by the NCP715 for given application conditions can be calculated from the following equations:

$$P_D \approx V_{IN}(I_{GND}(I_{OUT})) + I_{OUT}(V_{IN} - V_{OUT}) \quad (\text{eq. 2})$$

or

$$V_{IN(MAX)} \approx \frac{P_{D(MAX)} + (V_{OUT} \times I_{OUT})}{I_{OUT} + I_{GND}} \quad (\text{eq. 3})$$

For reliable operation, junction temperature should be limited to +125°C maximum.

### Hints

V<sub>IN</sub> and GND printed circuit board traces should be as wide as possible. When the impedance of these traces is high, there is a chance to pick up noise or cause the regulator to malfunction. Place external components, especially the output capacitor, as close as possible to the NCP715, and make traces as short as possible.

## ORDERING INFORMATION

Device	Nominal Output Voltage	Marking	Marking Rotation	Package	Shipping <sup>†</sup>
NCP715SQ12T2G	1.2 V	5A	-	SC88A/SC70 (Pb-Free)	3000 / Tape & Reel
NCP715SQ15T2G	1.5 V	5C			
NCP715SQ18T2G	1.8 V	5D			
NCP715SQ25T2G	2.5 V	5E			
NCP715SQ30T2G	3.0 V	5F			
NCP715SQ33T2G	3.3 V	5G			
NCP715SQ50T2G	5.0 V	5H			
NCP715MX12TBG	1.2 V	Q	0°	XDFN6 1.5 x 1.5 (Pb-Free)	
NCP715MX15TBG	1.5 V	R			
NCP715MX18TBG	1.8 V	T			
NCP715MX25TBG	2.5 V	V			
NCP715MX30TBG	3.0 V	Y			
NCP715MX33TBG	3.3 V	2			
NCP715MX50TBG	5.0 V	5			
NCP715MX53TBG	5.3 V	5	+180°		
NCP715SN33T1G	3.3 V	PZJ	-	TSOP-5 (Pb-Free)	

<sup>†</sup>For information on tape and reel specifications, including part orientation and tape sizes, please refer to our Tape and Reel Packaging Specifications Brochure, BRD8011/D.

# NCP715

## PACKAGE DIMENSIONS

**XDFN6 1.5x1.5, 0.5P**  
**CASE 711AE**  
**ISSUE B**

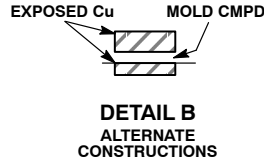
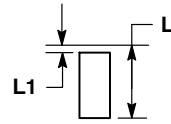
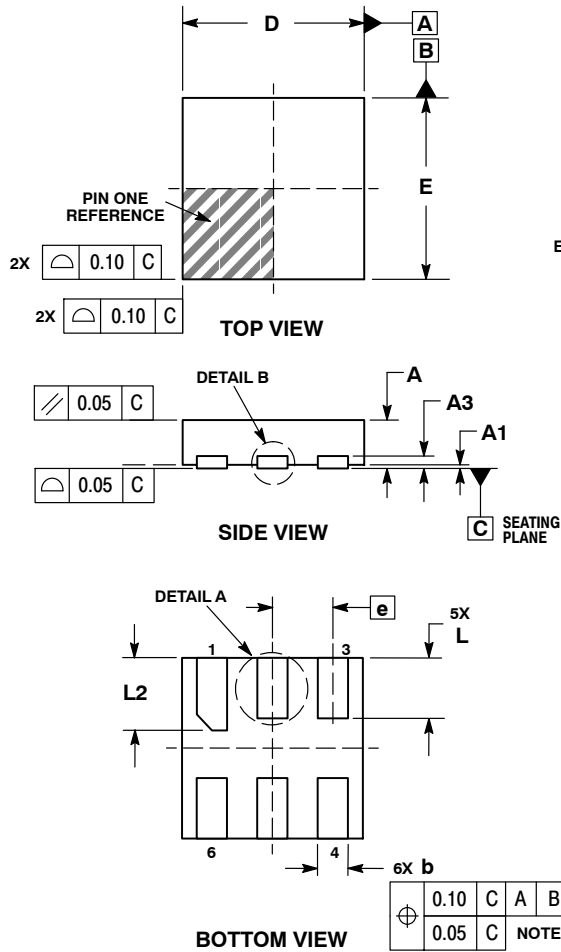

**NOTES:**

1. DIMENSIONING AND TOLERANCING PER ASME Y14.5M, 1994.
2. CONTROLLING DIMENSION: MILLIMETERS.
3. DIMENSION b APPLIES TO PLATED TERMINAL AND IS MEASURED BETWEEN 0.10 AND 0.20mm FROM TERMINAL TIP.

DIM	MILLIMETERS	
	MIN	MAX
A	0.35	0.45
A1	0.00	0.05
A3	0.13 REF	
b	0.20	0.30
D	1.50 BSC	
E	1.50 BSC	
e	0.50 BSC	
L	0.40	0.60
L1	---	0.15
L2	0.50	0.70

**RECOMMENDED MOUNTING FOOTPRINT\***

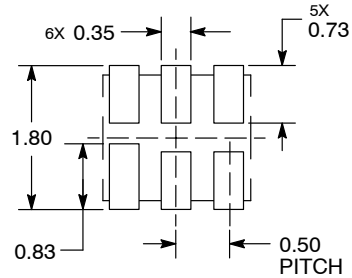

DIMENSIONS: MILLIMETERS

\*For additional information on our Pb-Free strategy and soldering details, please download the ON Semiconductor Soldering and Mounting Techniques Reference Manual, SOLDERRM/D.

# NCP715

## PACKAGE DIMENSIONS

**SC-88A (SC-70-5/SOT-353)**  
CASE 419A-02  
ISSUE L

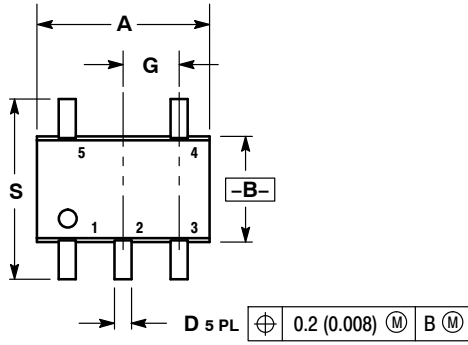

**NOTES:**

1. DIMENSIONING AND TOLERANCING PER ANSI Y14.5M, 1982.
2. CONTROLLING DIMENSION: INCH.
3. 419A-01 OBSOLETE. NEW STANDARD 419A-02.
4. DIMENSIONS A AND B DO NOT INCLUDE MOLD FLASH, PROTRUSIONS, OR GATE BURRS.

DIM	INCHES		MILLIMETERS	
	MIN	MAX	MIN	MAX
A	0.071	0.087	1.80	2.20
B	0.045	0.053	1.15	1.35
C	0.031	0.043	0.80	1.10
D	0.004	0.012	0.10	0.30
G	0.026 BSC		0.65 BSC	
H	---	0.004	---	0.10
J	0.004	0.010	0.10	0.25
K	0.004	0.012	0.10	0.30
N	0.008 REF		0.20 REF	
S	0.079	0.087	2.00	2.20

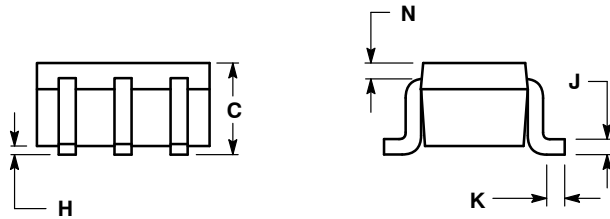

### SOLDER FOOTPRINT\*

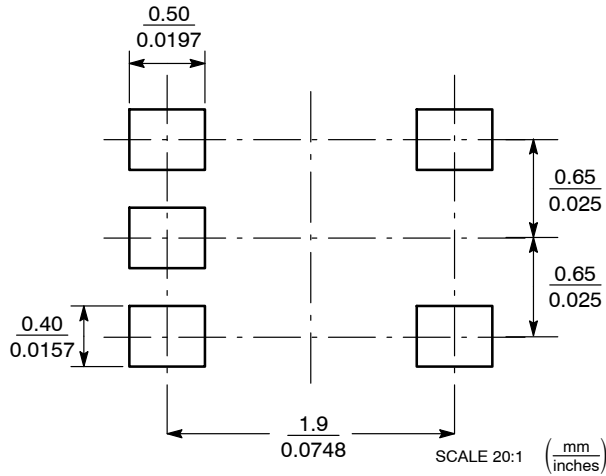

\*For additional information on our Pb-Free strategy and soldering details, please download the ON Semiconductor Soldering and Mounting Techniques Reference Manual, SOLDERRM/D.

# NCP715

## PACKAGE DIMENSIONS

TSOP-5  
CASE 483  
ISSUE M

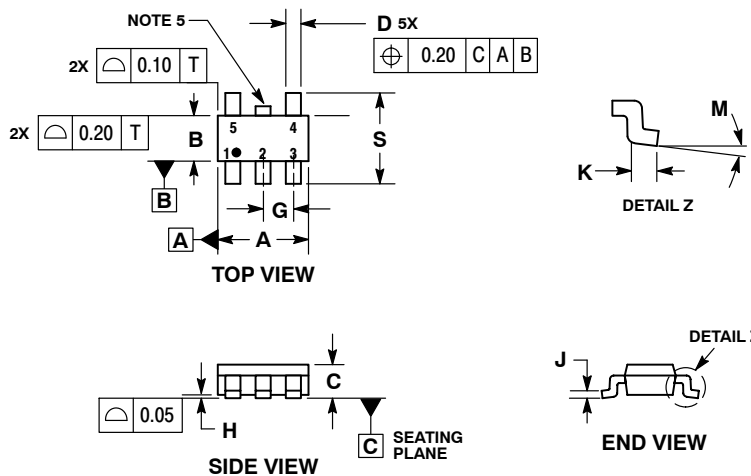

**NOTES:**

1. DIMENSIONING AND TOLERANCING PER ASME Y14.5M, 1994.
2. CONTROLLING DIMENSION: MILLIMETERS.
3. MAXIMUM LEAD THICKNESS INCLUDES LEAD FINISH THICKNESS. MINIMUM LEAD THICKNESS IS THE MINIMUM THICKNESS OF BASE MATERIAL.
4. DIMENSIONS A AND B DO NOT INCLUDE MOLD FLASH, PROTRUSIONS, OR GATE BURRS. MOLD FLASH, PROTRUSIONS, OR GATE BURRS SHALL NOT EXCEED 0.15 PER SIDE. DIMENSION A.
5. OPTIONAL CONSTRUCTION: AN ADDITIONAL TRIMMED LEAD IS ALLOWED IN THIS LOCATION. TRIMMED LEAD NOT TO EXTEND MORE THAN 0.2 FROM BODY.

DIM	MILLIMETERS	
	MIN	MAX
A	2.85	3.15
B	1.35	1.65
C	0.90	1.10
D	0.25	0.50
G	0.95 BSC	
H	0.01	0.10
J	0.10	0.26
K	0.20	0.60
M	0° 10°	
S	2.50	3.00

### SOLDERING FOOTPRINT\*

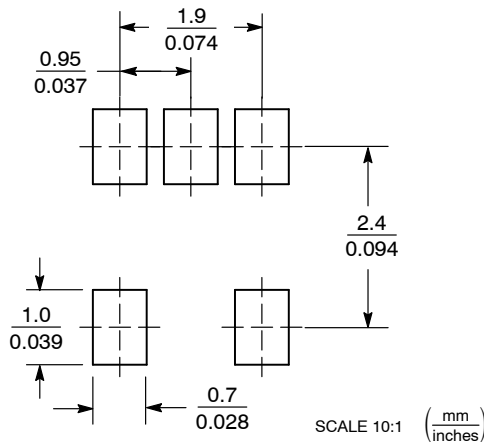

\*For additional information on our Pb-Free strategy and soldering details, please download the ON Semiconductor Soldering and Mounting Techniques Reference Manual, SOLDERRM/D.

ON Semiconductor and are trademarks of Semiconductor Components Industries, LLC dba ON Semiconductor or its subsidiaries in the United States and/or other countries. ON Semiconductor owns the rights to a number of patents, trademarks, copyrights, trade secrets, and other intellectual property. A listing of ON Semiconductor's product/patent coverage may be accessed at [www.onsemi.com/site/pdf/Patent-Marking.pdf](http://www.onsemi.com/site/pdf/Patent-Marking.pdf). ON Semiconductor reserves the right to make changes without further notice to any products herein. ON Semiconductor makes no warranty, representation or guarantee regarding the suitability of its products for any particular purpose, nor does ON Semiconductor assume any liability arising out of the application or use of any product or circuit, and specifically disclaims any and all liability, including without limitation special, consequential or incidental damages. Buyer is responsible for its products and applications using ON Semiconductor products, including compliance with all laws, regulations and safety requirements or standards, regardless of any support or applications information provided by ON Semiconductor. "Typical" parameters which may be provided in ON Semiconductor data sheets and/or specifications can and do vary in different applications and actual performance may vary over time. All operating parameters, including "Typicals" must be validated for each customer application by customer's technical experts. ON Semiconductor does not convey any license under its patent rights nor the rights of others. ON Semiconductor products are not designed, intended, or authorized for use as a critical component in life support systems or any FDA Class 3 medical devices or medical devices with a same or similar classification in a foreign jurisdiction or any devices intended for implantation in the human body. Should Buyer purchase or use ON Semiconductor products for any such unintended or unauthorized application, Buyer shall indemnify and hold ON Semiconductor and its officers, employees, subsidiaries, affiliates, and distributors harmless against all claims, costs, damages, and expenses, and reasonable attorney fees arising out of, directly or indirectly, any claim of personal injury or death associated with such unintended or unauthorized use, even if such claim alleges that ON Semiconductor was negligent regarding the design or manufacture of the part. ON Semiconductor is an Equal Opportunity/Affirmative Action Employer. This literature is subject to all applicable copyright laws and is not for resale in any manner.

### PUBLICATION ORDERING INFORMATION

**LITERATURE FULFILLMENT:**

Literature Distribution Center for ON Semiconductor  
19521 E. 32nd Pkwy, Aurora, Colorado 80011 USA  
Phone: 303-675-2175 or 800-344-3860 Toll Free USA/Canada  
Fax: 303-675-2176 or 800-344-3867 Toll Free USA/Canada  
Email: [orderlit@onsemi.com](mailto:orderlit@onsemi.com)

**N. American Technical Support:** 800-282-9855 Toll Free  
USA/Canada  
**Europe, Middle East and Africa Technical Support:**  
Phone: 421 33 790 2910

**ON Semiconductor Website:** [www.onsemi.com](http://www.onsemi.com)  
**Order Literature:** <http://www.onsemi.com/orderlit>

For additional information, please contact your local Sales Representative

## Looking for pricing, stock, or lifecycle information?

Click below to explore more details on WIN SOURCE:

- ⊖ [View NCP715SQ18T2G on WIN SOURCE](#)
- ⊖ [ON Semiconductor Information](#)

## Optimize Your Supply Chain with WIN SOURCE Solutions

- ✓ Global Sourcing Solution
- ✓ Obsolete Management
- ✓ Cost Control Management
- ✓ Shortage Management
- ✓ Alternative Solution
- ✓ Excess Inventory Management