



**THE DATASHEET OF
NCV5662DSADJR4G**



NCP5662, NCV5662

Low Output Voltage, Ultra-Fast 2.0 A Low Dropout Linear Regulator with Enable

The NCP5662/NCV5662 is a high performance, low dropout linear regulator designed for high power applications that require up to 2.0 A current. It is offered in both fixed and adjustable output versions. With output voltages as low as 0.9 V and ultra-fast response times for load transients, the NCP5662/NCV5662 also provides additional features such as Enable and Error Flag (for the fixed output version), increasing the utility of these devices. A thermally robust, 5 pin D²PAK or DFN8 package, combined with an architecture that offers low ground current (independent of load), provides for a superior high-current LDO solution.

Features

- Ultra-Fast Transient Response (Settling Time: 1–3 μ s)
- Low Noise Without Bypass Capacitor (26 μ V_{rms})
- Low Ground Current Independent of Load (3.0 mA Maximum)
- Fixed/Adjustable Output Voltage Versions
- Enable Function
- Error Flag (Fixed Output Version)
- Current Limit Protection
- Thermal Shutdown Protection (160°C)
- 0.9 V Reference Voltage for Ultra-Low Output Operation
- Power Supply Rejection Ratio > 65 dB
- NCV Prefix for Automotive and Other Applications Requiring Unique Site and Control Change Requirements; AEC-Q100 Qualified and PPAP Capable
- These are Pb-Free Devices

Applications

- Servers
- ASIC Power Supplies
- Post Regulation for Power Supplies
- Constant Current Source
- Networking Equipment
- Gaming and STB Modules



ON Semiconductor®

www.onsemi.com

MARKING DIAGRAMS AND PIN ASSIGNMENTS

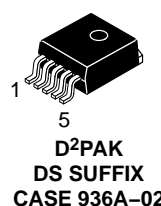

Tab = GND
Pin 1 = EN
2 = V_{in}
3 = GND
4 = V_{out}
5 = ADJ/EF

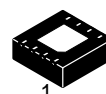

DFN8
MN SUFFIX
CASE 488AF

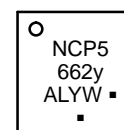

Fixed Version

Pin 1 = EF
2 = GND
3 = N/C
4 = EN
5, 6 = V_{in}
7, 8 = V_{out}

Adjustable Version

Pin 1 = ADJ
2 = GND
3 = N/C
4 = EN
5, 6 = V_{in}
7 = V_{out}
8 = N/C

x = P or V
y = A for Adjustable Version
B for Fixed 1.5 V Version
C for Fixed 3.3 V Version
D for Fixed 1.2 V Version
E for Fixed 1.8 V Version
F for Fixed 2.5 V Version
G for Fixed 2.8 V Version
H for Fixed 3.0 V Version
A = Assembly Location
L = Wafer Lot
Y = Year
WW = Work Week
G or ■ = Pb-Free Package

(Note: Microdot may be in either location)

ORDERING INFORMATION

See detailed ordering and shipping information in the package dimensions section on page 13 of this data sheet.

NCP5662, NCV5662

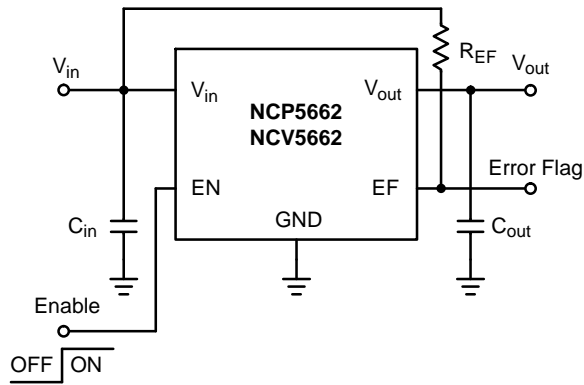

Figure 1. Typical Application Schematic, Fixed Output

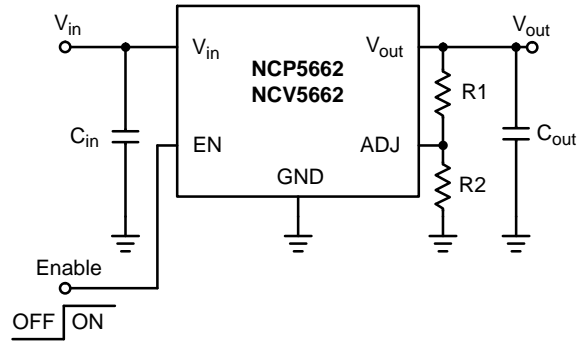

Figure 2. Typical Application Schematic, Adjustable Output

PIN FUNCTION DESCRIPTION

Pin Adj/Fixed D ² PAK	Pin Adj/Fixed DFN8	Pin Name	Description
1	4	EN	Enable. This pin allows for on/off control of the regulator. To disable the device, connect to Ground. If this function is not in use, connect to V_{in} .
2	5, 6*	V_{in}	Positive Power Supply Input Voltage
3, TAB	2	GND	Power Supply Ground
4	7, 8	V_{out}	Regulated Output Voltage
5	1	ADJ (Adjustable Version)	This pin is connected to the resistor divider network and programs the output voltage.
5	1	EF (Fixed Version)	An Error Flag is triggered when the output voltage is out of regulation excluding transient signals that may occur. Requires a pullup resistor $\approx 100\text{ k}\Omega$.
-	3, 8	Pin 3 N/C on Fixed & ADJ Version while Pin 8 N/C on ADJ Version only	No connection. True no connect. PCB runs allowable.
-	EPAD	EPAD	Exposed thermal pad should be connected to ground.

*Pins 5 and 6 must be connected together externally for output current full range operation.

NCP5662, NCV5662

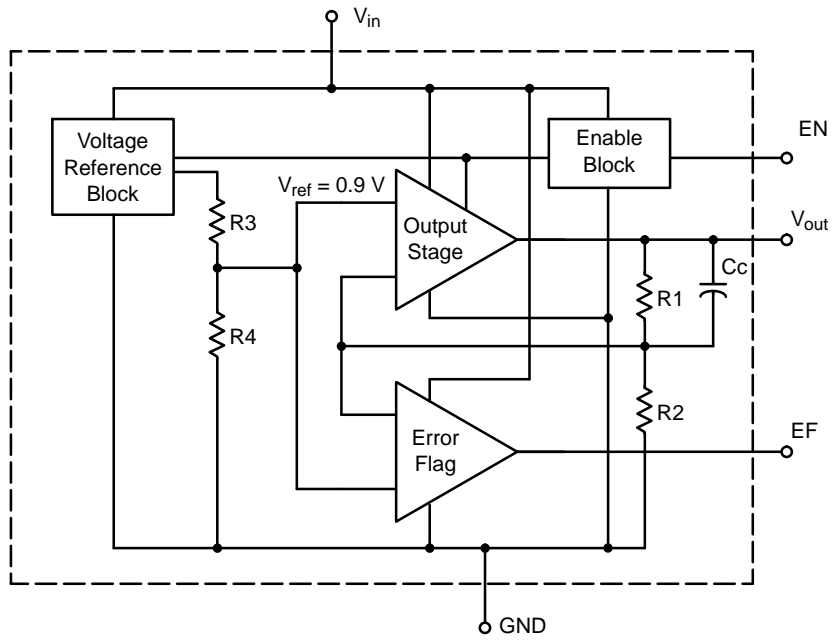

Figure 3. Block Diagram, Fixed Output

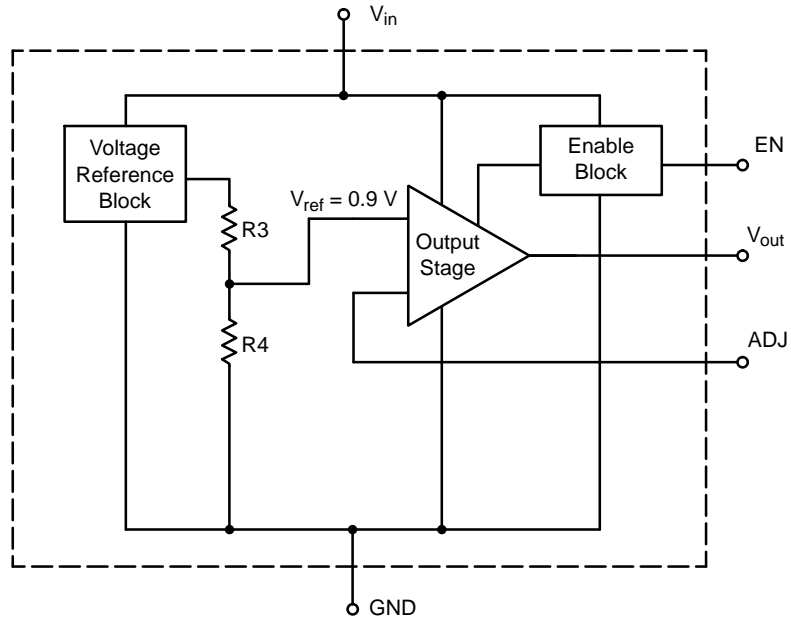

Figure 4. Block Diagram, Adjustable Output

NCP5662, NCV5662

ABSOLUTE MAXIMUM RATINGS

Rating	Symbol	Value	Unit
Input Voltage (Note 1)	V_{in}	18	V
Output Pin Voltage	V_{out}	-0.3 to ($V_{in} + 0.3$)	V
Adjust Pin Voltage	V_{ADJ}	-0.3 to ($V_{in} + 0.3$)	V
Enable Pin Voltage	V_{EN}	-0.3 to ($V_{in} + 0.3$)	V
Error Flag Voltage	V_{EF}	-0.3 to ($V_{in} + 0.3$)	V
Error Flag Current	I_{EF}	3.0	mA
Maximum Junction Temperature	$T_{J(max)}$	150	°C

Stresses exceeding those listed in the Maximum Ratings table may damage the device. If any of these limits are exceeded, device functionality should not be assumed, damage may occur and reliability may be affected.

NOTE: This device series contains ESD protection and exceeds the following tests:

Human Body Model (HBM), Class 3A, 2000 V

Machine Model (MM), Class C, 200 V

Charge Device Model (CDM), Class IV, 2000 V.

1. Refer to Electrical Characteristics and Application Information for Safe Operating Area.

THERMAL CHARACTERISTICS

Rating	Symbol	Value	Unit
Thermal Characteristics, D ² PAK (Notes 1 and 2)			°C/W
Thermal Resistance, Junction-to-Ambient	$R_{\theta JA}$	45	
Thermal Resistance, Junction-to-Case	$R_{\theta JC}$	5.0	
Thermal Reference, Junction-to-Lead	$R_{\psi JL}$	7.0	
Thermal Characteristics, DFN8 (Notes 1 and 2)			°C/W
Thermal Resistance, Junction-to-Ambient	$R_{\theta JA}$	78	
Thermal Reference, Junction-to-Lead (Note 3)	$R_{\psi JL}$	14	

2. As measured using a copper heat spreading area of 1 sq in copper, 1 oz copper thickness.

3. Lead 6.

OPERATING RANGES

Rating	Symbol	Value	Unit
Operating Input Voltage (Note 1)	V_{in}	($V_{out} + V_{DO}$), 2 to 9 (Note 4)	V
Operating Ambient Temperature Range	T_A	-40 to +85 -40 to +125	°C
Storage Temperature Range	T_{stg}	-55 to +150	°C

4. Minimum $V_{in} = (V_{out} + V_{DO})$ or 2 V, whichever is higher.

NCP5662, NCV5662

ELECTRICAL CHARACTERISTICS ($V_{in} = V_{out} + 1.5\text{ V}$, for typical values $T_A = 25^\circ\text{C}$, for min/max values $T_A = -40^\circ\text{C}$ to 85°C (NCP version), $T_A = -40^\circ\text{C}$ to 125°C (NCV version), $C_{in} = C_{out} = 150\ \mu\text{F}$ unless otherwise noted. (Note 5))

Characteristic	Symbol	Min	Typ	Max	Unit
ADJUSTABLE OUTPUT VERSION					
Output Noise Voltage	V_n	–	26	–	μV_{rms}
Output Voltage $T_A = 25^\circ\text{C}$ ($V_{in} = V_{out} + 1.5\text{ V}$ to 7.0 V , $I_{out} = 10\text{ mA}$ to 2.0 A) $T_A = -20$ to $+125^\circ\text{C}$ ($V_{in} = V_{out} + 1.5\text{ V}$ to 7.0 V , $I_{out} = 10\text{ mA}$ to 2.0 A) $T_A = -40$ to $+150^\circ\text{C}$ ($V_{in} = V_{out} + 1.5\text{ V}$ to 7.0 V , $I_{out} = 10\text{ mA}$ to 2.0 A)	V_{out}	(–1%) (–1.5%) (–2%)	– 0.9 –	(+1%) (+1.5%) (+2%)	V
Adjustable Pin Input Current	I_{ADJ}	–	40	–	nA
Line Regulation ($I_{out} = 10\text{ mA}$, $V_{out} + 1.5\text{ V} < V_{in} < 7.0\text{ V}$)	REG_{line}	–	0.03	–	%
Load Regulation ($10\text{ mA} < I_{out} < 2.0\text{ A}$)	REG_{load}	–	0.03	–	%
Dropout Voltage ($I_{out} = 2.0\text{ A}$)	V_{DO}	–	1.0	1.3	V
Peak Output Current Limit	$I_{out(\text{peak})}$	2.0	–	–	A
Internal Current Limitation	I_{LIM}	–	3.0	–	A
Ripple Rejection (120 Hz) Ripple Rejection (1 kHz)	RR	–	70 65	–	dB
Ground Current $I_{out} = 2.0\text{ A}$ Disabled State	I_{GND} $I_{GND(\text{DIS})}$	–	1.3 10	3.0 300	mA μA
Enable Input Threshold Voltage Voltage Increasing, On state, Logic High Voltage Decreasing, Off state, Logic Low	V_{EN}	1.3 –	– –	– 0.3	V
Enable Input Current Enable Pin Voltage = $0.3\text{ V}_{\text{max}}$ Enable Pin Voltage = $1.3\text{ V}_{\text{min}}$	I_{EN}	– –	0.5 0.5	– –	μA

5. Performance guaranteed over specified operating conditions by design, guard banded test limits, and/or characterization, production tested at $T_J = T_A = 25^\circ\text{C}$. Low duty cycle pulse techniques are used during testing to maintain the junction temperature as close to ambient as possible.

NCP5662, NCV5662

ELECTRICAL CHARACTERISTICS ($V_{in} = V_{out} + 1.5$ V, for typical values $T_A = 25^\circ\text{C}$, for min/max values $T_A = -40^\circ\text{C}$ to 85°C (NCP version), $T_A = -40^\circ\text{C}$ to 125°C (NCV version), $C_{in} = C_{out} = 150$ μF unless otherwise noted. (Note 6))

Characteristic	Symbol	Min	Typ	Max	Unit
FIXED OUTPUT VOLTAGE					
Output Noise Voltage ($V_{out} = 0.9$ V)	V_n	–	26	–	μV_{rms}
Output Voltage (Note 7) $T_A = 25^\circ\text{C}$ ($V_{in} = V_{out} + 1.5$ V to 7.0 V, $I_{out} = 10$ mA to 2.0 A) $T_A = -20$ to $+125^\circ\text{C}$ ($V_{in} = V_{out} + 1.5$ V to 7.0 V, $I_{out} = 10$ mA to 2.0 A) $T_A = -40$ to $+150^\circ\text{C}$ ($V_{in} = V_{out} + 1.5$ V to 7.0 V, $I_{out} = 10$ mA to 2.0 A)	V_{out}	(–1%) (–1.5%) (–2%)	– $V_{out(nom)}$ –	(+1%) (+1.5%) (+2%)	V
Line Regulation ($I_{out} = 10$ mA, $V_{out} + 1.5$ V < V_{in} < 7.0 V)	REG_{line}	–	0.03	–	%
Load Regulation (10 mA < I_{out} < 2.0 A)	REG_{load}	–	0.2	–	%
Dropout Voltage ($I_{out} = 2.0$ A)	V_{DO}	–	1.0	1.3	V
Peak Output Current Limit	$I_{out(peak)}$	2.0	–	–	A
Internal Current Limitation	I_{LIM}	–	3.0	–	A
Ripple Rejection (120 Hz)	RR	–	70	–	dB
Ripple Rejection (1 kHz)		–	65	–	
Ground Current $I_{out} = 2.0$ A Disabled State	I_{GND} $I_{GND(DIS)}$	– –	1.3 30	3.0 300	mA μA
Enable Input Threshold Voltage Voltage Increasing, On state, Logic High Voltage Decreasing, Off state, Logic Low	V_{EN}	1.3 –	– –	– 0.3	V
Enable Input Current Enable Pin Voltage = 0.3 V_{max} Enable Pin Voltage = 1.3 V_{min}	I_{EN}	– –	0.5 0.5	– –	μA
Error Flag Voltage Threshold (Fixed Output)	$V_{EF(VT)}$	91	94	97	% of V_{out}
Error Flag Output Low Voltage Saturation ($I_{EF} = 1.0$ mA)	$V_{EF(SAT)}$	–	200	–	mV
Error Flag Leakage	$I_{EF(leakage)}$	–	1.0	–	μA
Error Flag Blanking Time (Note 8)	t_{EF}	–	50	–	μs

6. Performance guaranteed over specified operating conditions by design, guard banded test limits, and/or characterization, production tested at $T_J = T_A = 25^\circ\text{C}$. Low duty cycle pulse techniques are used during testing to maintain the junction temperature as close to ambient as possible.
7. Fixed output voltage available at 0.9 V per request.
8. Can be disabled per customer request.

NCP5662, NCV5662

TYPICAL CHARACTERISTICS

(Typical characteristics were measured with the same conditions as electrical characteristics, unless otherwise noted)

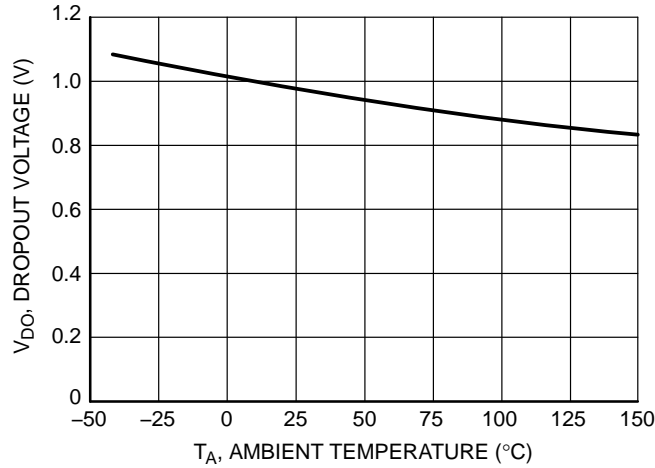

Figure 5. Dropout Voltage vs. Temperature

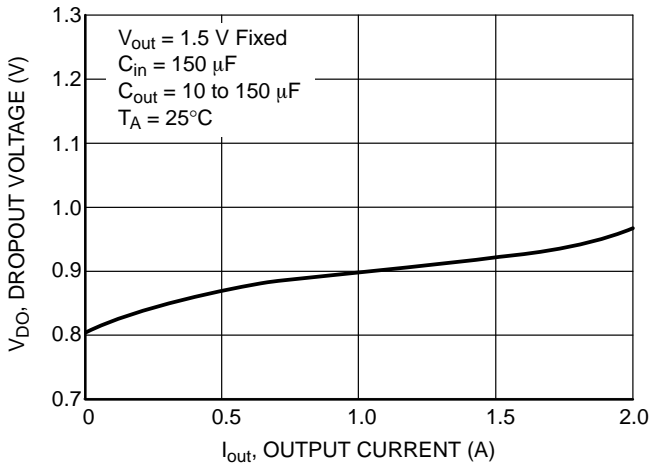

Figure 6. 1.5 V Dropout Voltage vs. Output Current

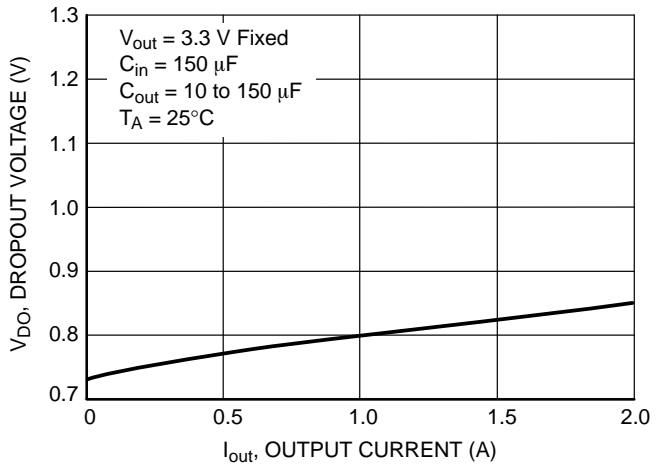

Figure 7. 3.3 V Dropout Voltage vs. Output Current

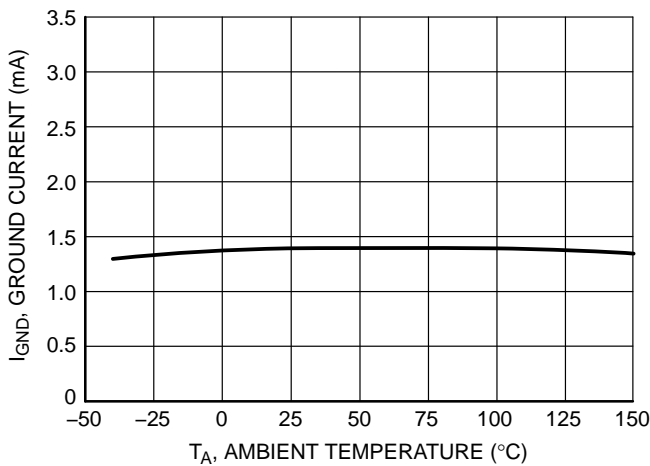

Figure 8. Ground Current vs. Temperature

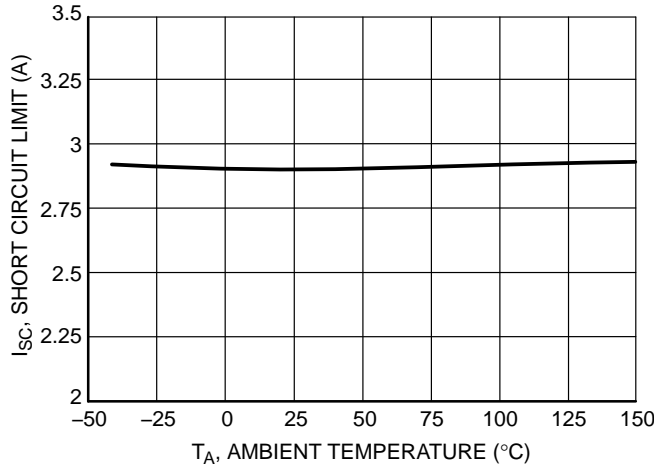

Figure 9. Short Circuit Current Limit vs. Temperature

TYPICAL CHARACTERISTICS

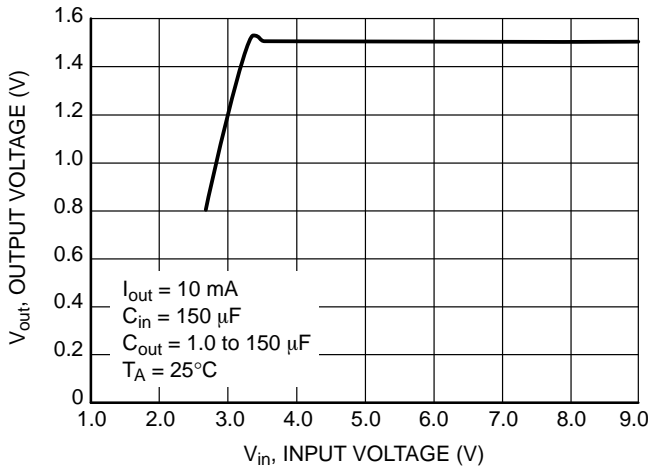

Figure 10. 1.5 V Output Voltage vs. Input Voltage

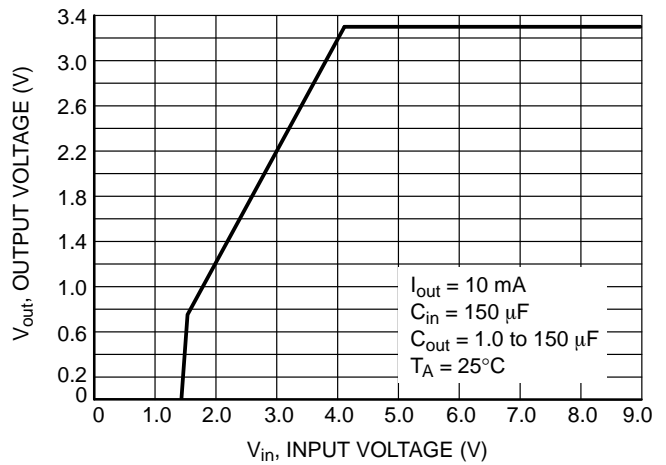

Figure 11. 3.3 V Output Voltage vs. Input Voltage

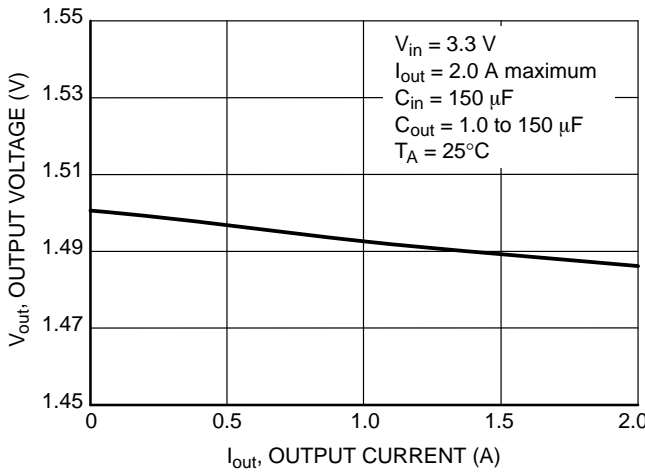

Figure 12. 1.5 V Output Voltage vs. Output Load Current

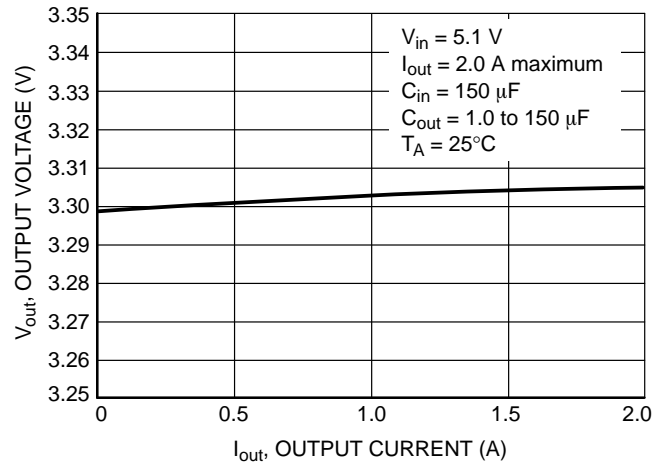

Figure 13. 3.3 V Output Voltage vs. Output Load Current

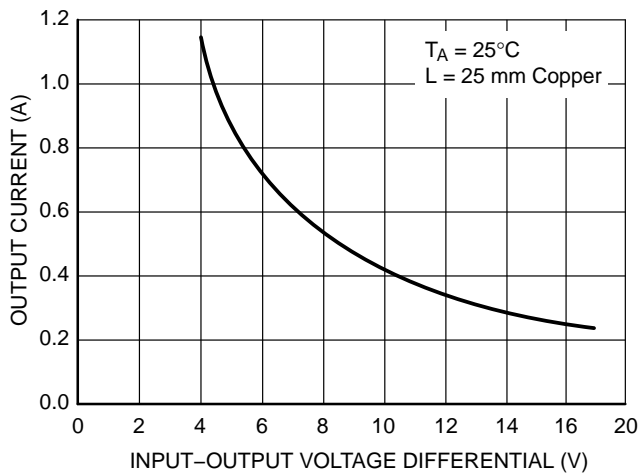

Figure 14. Output Current vs. Input-Output Voltage Differential

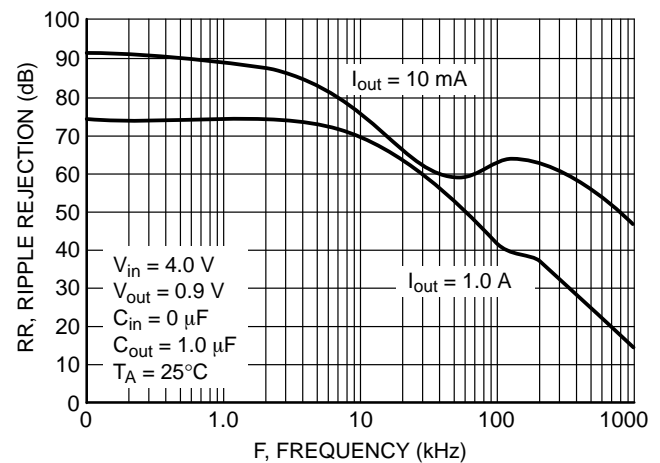

Figure 15. Ripple Rejection vs. Frequency

NCP5662, NCV5662

TYPICAL CHARACTERISTICS

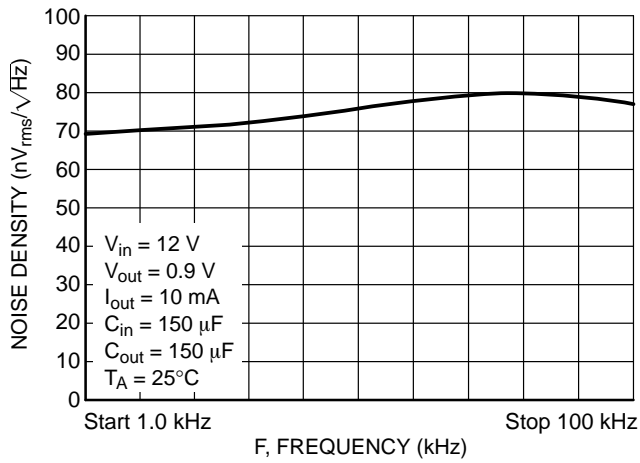

Figure 16. Noise Density vs. Frequency

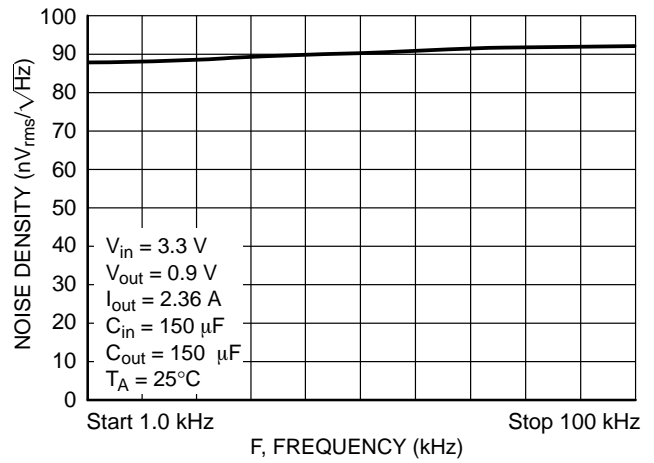

Figure 17. Noise Density vs. Frequency

TYPICAL CHARACTERISTICS

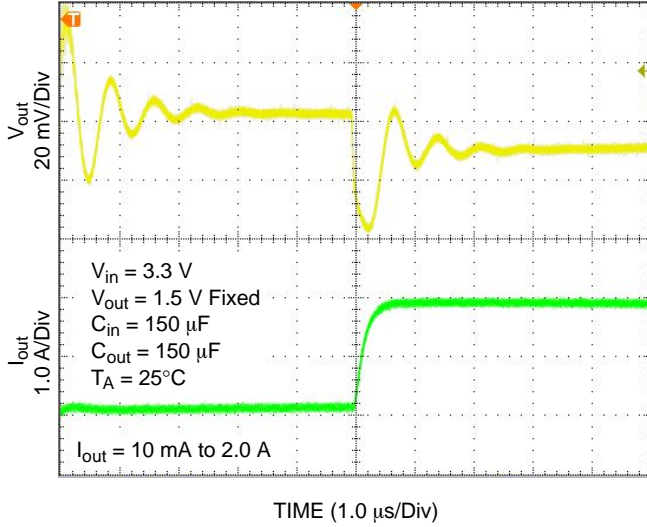

Figure 18. Load Transient Response

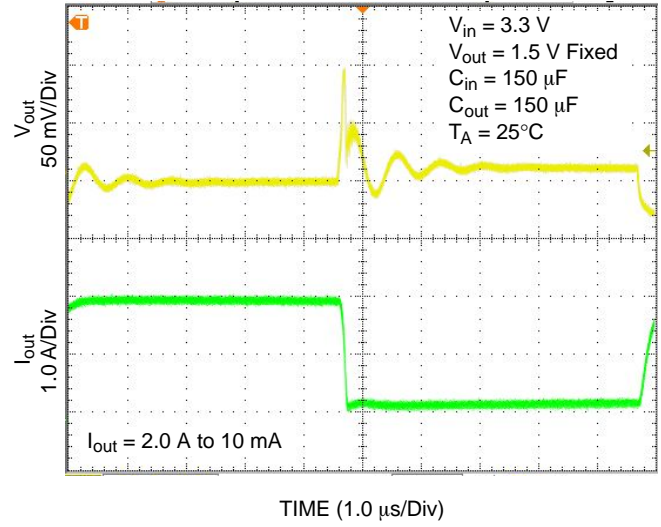

Figure 19. Load Transient Response

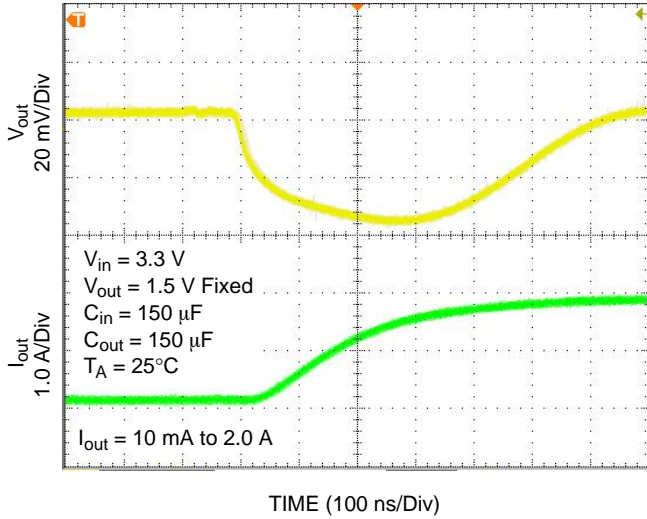

Figure 20. Load Transient Response

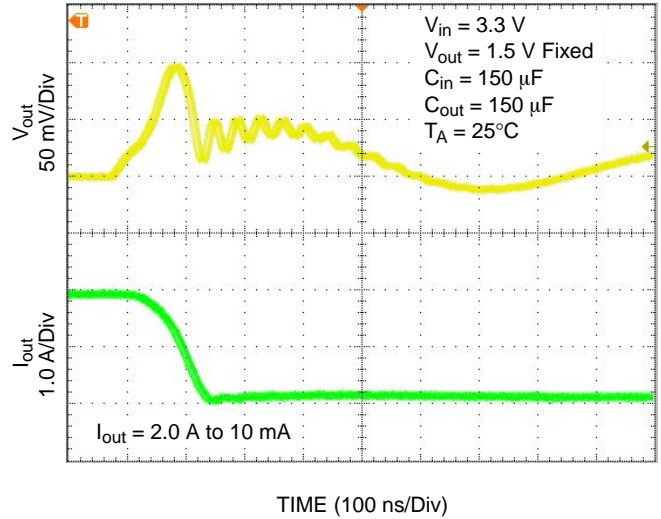

Figure 21. Load Transient Response

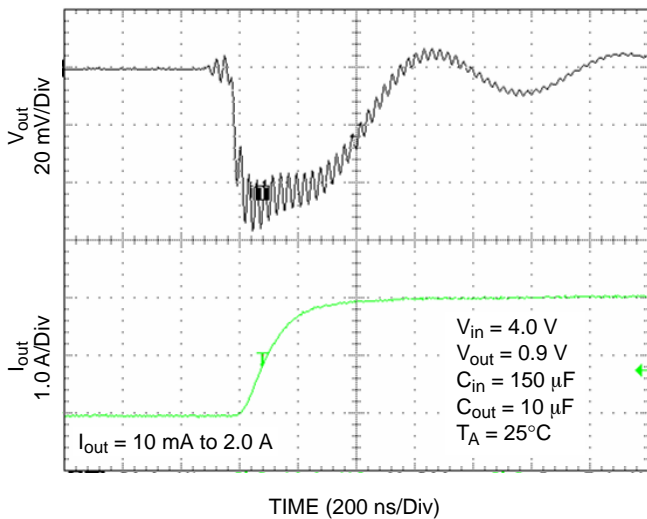

Figure 22. Load Transient Response

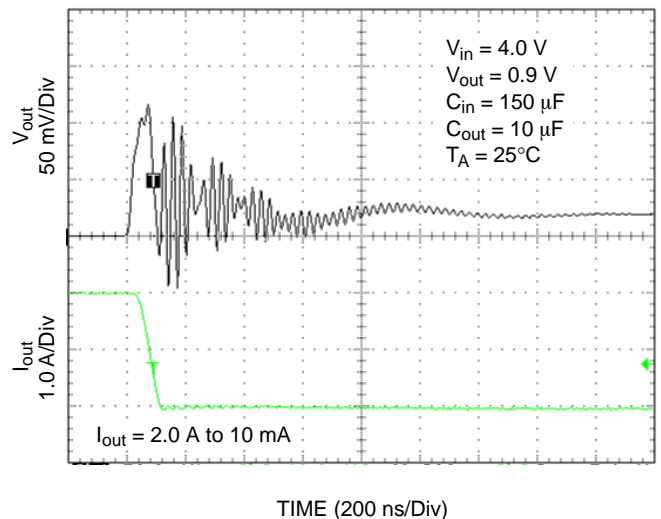

Figure 23. Load Transient Response

APPLICATION INFORMATION

The NCP5662 is a high performance low dropout 2.0 A linear regulator suitable for high power applications, featuring an ultra-fast response time and low noise without a bypass capacitor. It is offered in both fixed and adjustable output versions with voltages as low as 0.9 V. Additional features, such as Enable and Error Flag (fixed output version) increase the utility of the NCP5662. It is thermally robust and includes the safety features necessary during a fault condition, which provide for an attractive high current LDO solution for server, ASIC power supplies, networking equipment applications, and many others.

Input Capacitor

The recommended input capacitor value is a 150 µF OSCON with an Equivalent Series Resistance (ESR) of 50 mΩ. It is especially required if the power source is located more than a few inches from the NCP5662. This capacitor will reduce device sensitivity and enhance the output transient response time. The PCB layout is very important and in order to obtain the optimal solution, the Vin and GND traces should be sufficiently wide to minimize noise and unstable operation.

Output Capacitor

Proper output capacitor selection is required to maintain stability. The NCP5662 is guaranteed to be stable at an output capacitance of, C_{out} > 10 µF with an ESR between 50 mΩ and 300 mΩ over the output current range of 10 mA to 2.0 A. For PCB layout considerations, place the recommended ceramic capacitor close to the output pin and keep the leads short. This should help ensure ultra-fast transient response times.

Adjustable Output Operation

The application circuit for the adjustable output version is shown in Figure 2. The reference voltage is 0.9 V and the adjustable pin current is typically 40 nA. A resistor divider network, R1 and R2, is calculated using the following formula:

$$R1 = R2 \left(\frac{V_{out}}{V_{ref}} - 1 \right)$$

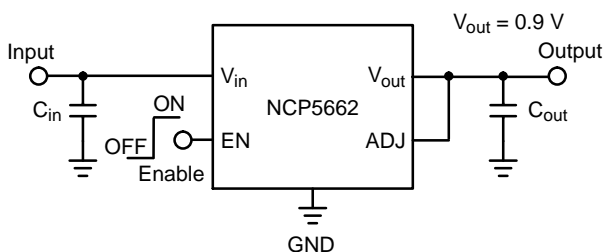

Figure 24. To achieve the minimum output voltage, ADJ to V_{out} has to be connected together

Current Limit Operation

As the peak output current increases beyond its limitation, the device is internally clamped to 3.0 A, thus causing the output voltage to decrease and go out of regulation. This allows the device never to exceed the maximum power dissipation.

Error Flag Operation

The Error Flag pin on the NCP5662 will produce a logic Low when it drops below the nominal output voltage. Refer to the electrical characteristics for the threshold values at which point the Error Flag goes Low. When the NCP5662 is above the nominal output voltage, the Error Flag will remain at logic High.

The external pullup resistor needs to be connected between V_{in} and the Error Flag pin. A resistor of approximately 100 kΩ is recommended to minimize the current consumption. No pullup resistor is required if the Error Flag output is not being used.

Thermal Consideration

The maximum package power dissipation is:

$$P_D = \frac{T_{J(max)} - T_A}{R_{\theta JA}}$$

The bipolar process employed for this IC is fully characterized and rated for reliable 18 V operation. To avoid damaging the part or degrading its reliability, power dissipation transients should be limited to under 30 W for D²PAK. For open-circuit to short-circuit transient,

$$P_{DTransient} = V_{in(operating\ max)} * I_{SC}$$

NCP5662, NCV5662

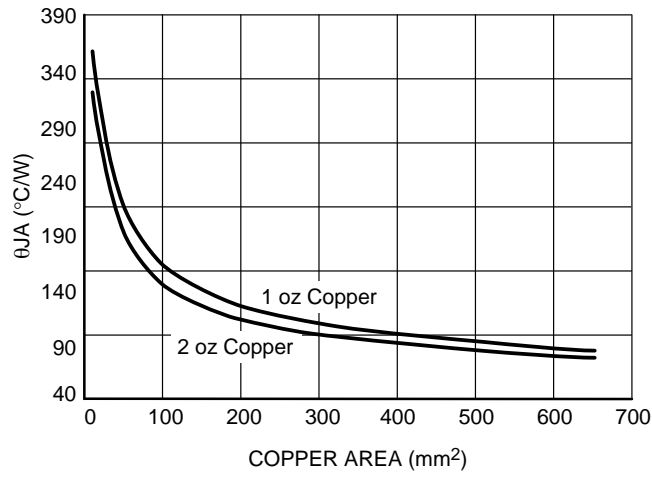

Figure 25. DFN8 Thermal Resistance vs. Copper Area

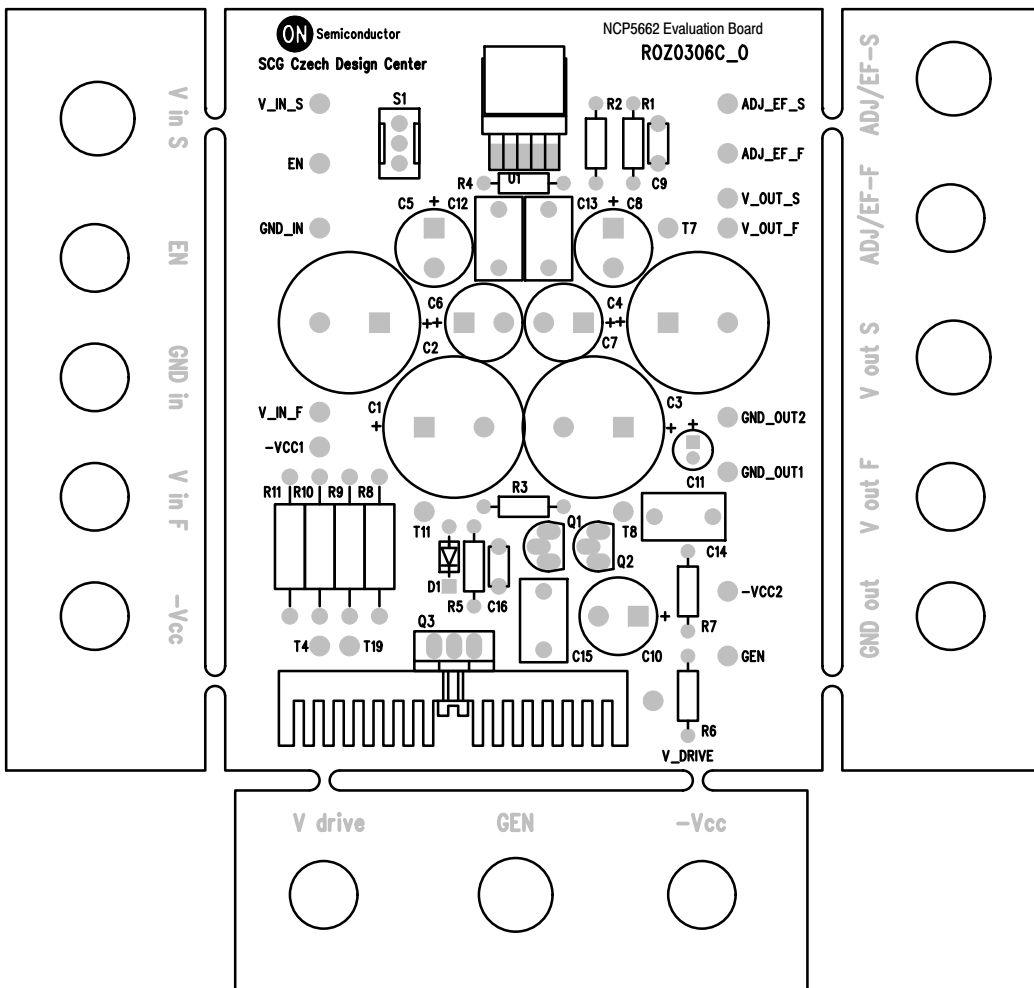

Figure 26. Test Board used for Evaluation

NCP5662, NCV5662

ORDERING INFORMATION

Device	Nominal Output Voltage	Package	Shipping†
NCP5662DSADJR4G	Adj (Pb-Free)	D ² PAK	800 / Tape & Reel
NCP5662DS12R4G	Fixed, 1.2 V (Pb-Free)		
NCP5662DS15R4G	Fixed, 1.5 V (Pb-Free)		
NCP5662DS18R4G	Fixed, 1.8 V (Pb-Free)		
NCP5662DS25R4G	Fixed, 2.5 V (Pb-Free)		
NCP5662DS28R4G	Fixed, 2.8 V (Pb-Free)		
NCP5662DS30R4G	Fixed, 3.0 V (Pb-Free)		
NCP5662DS33R4G	Fixed, 3.3 V (Pb-Free)		
NCV5662DSADJR4G*	Adj (Pb-Free)		
NCV5662DS15R4G*	Fixed, 1.5 V (Pb-Free)		
NCV5662DS33R4G*	Fixed, 3.3 V (Pb-Free)		
NCP5662MNADJR2G	Adj (Pb-Free)	DFN8	3000 / Tape & Reel
NCP5662MN15R2G	Fixed, 1.5 V (Pb-Free)		
NCP5662MN33R2G	Fixed, 3.3 V (Pb-Free)		

†For information on tape and reel specifications, including part orientation and tape sizes, please refer to our Tape and Reel Packaging Specifications Brochure, BRD8011/D.

*NCV Prefix for Automotive and Other Applications Requiring Unique Site and Control Change Requirements; AEC-Q100 Qualified and PPAP Capable

NCP5662, NCV5662

PACKAGE DIMENSIONS

D²PAK 5-LEAD CASE 936A-02 ISSUE D

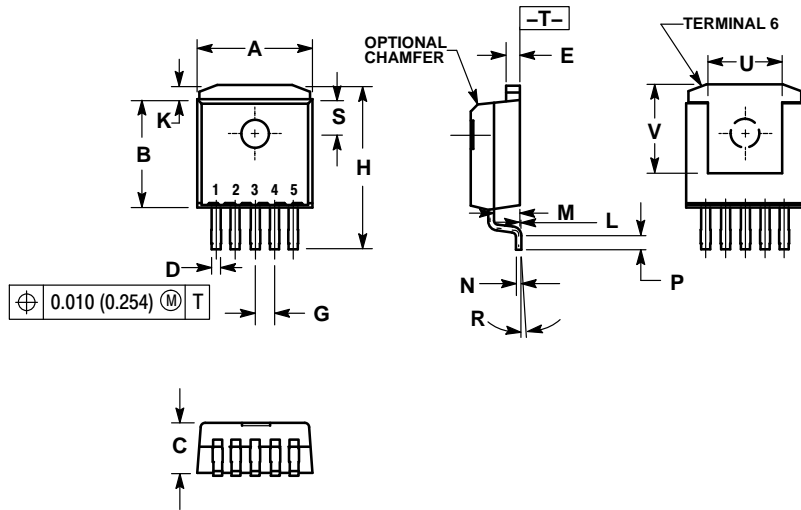

NOTES:

1. DIMENSIONING AND TOLERANCING PER ANSI Y14.5M, 1982.
2. CONTROLLING DIMENSION: INCH.
3. TAB CONTOUR OPTIONAL WITHIN DIMENSIONS A AND K.
4. DIMENSIONS U AND V ESTABLISH A MINIMUM MOUNTING SURFACE FOR TERMINAL 6.
5. DIMENSIONS A AND B DO NOT INCLUDE MOLD FLASH OR GATE PROTRUSIONS. MOLD FLASH AND GATE PROTRUSIONS NOT TO EXCEED 0.025 (0.635) MAXIMUM.

DIM	INCHES		MILLIMETERS	
	MIN	MAX	MIN	MAX
A	0.386	0.403	9.804	10.236
B	0.356	0.368	9.042	9.347
C	0.170	0.180	4.318	4.572
D	0.026	0.036	0.660	0.914
E	0.045	0.055	1.143	1.397
G	0.067 BSC		1.702 BSC	
H	0.539	0.579	13.691	14.707
K	0.050 REF		1.270 REF	
L	0.000	0.010	0.000	0.254
M	0.088	0.102	2.235	2.591
N	0.018	0.026	0.457	0.660
P	0.058	0.078	1.473	1.981
R	0°	8°	0°	8°
S	0.116 REF		2.946 REF	
U	0.200 MIN		5.080 MIN	
V	0.250 MIN		6.350 MIN	

SOLDERING FOOTPRINT

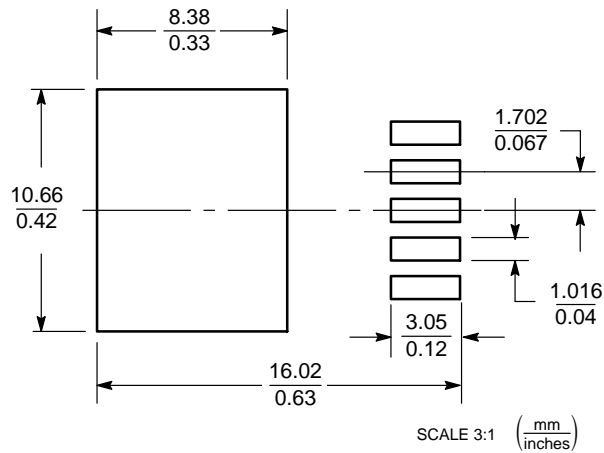

5-LEAD D²PAK

NCP5662, NCV5662

PACKAGE DIMENSIONS

8 PIN DFN, 4x4 CASE 488AF ISSUE C

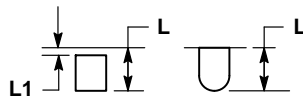
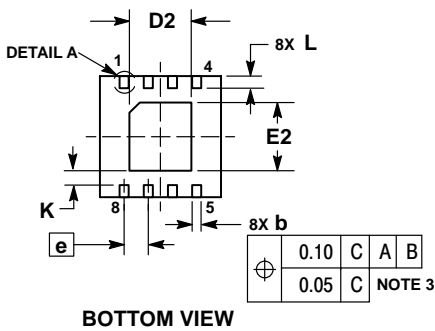
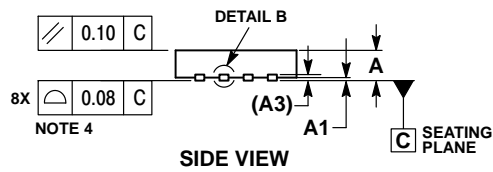
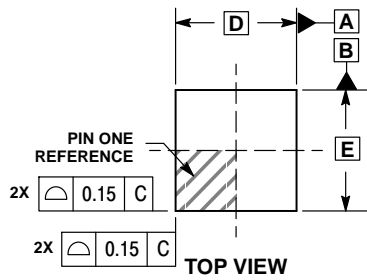

**DETAIL A
OPTIONAL
CONSTRUCTIONS**

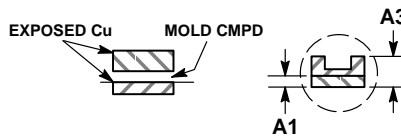

**DETAIL B
ALTERNATE
CONSTRUCTIONS**

NOTES:

1. DIMENSIONS AND TOLERANCING PER ASME Y14.5M, 1994.
2. CONTROLLING DIMENSION: MILLIMETERS.
3. DIMENSION b APPLIES TO PLATED TERMINAL AND IS MEASURED BETWEEN 0.15 AND 0.30MM FROM TERMINAL TIP.
4. COPLANARITY APPLIES TO THE EXPOSED PAD AS WELL AS THE TERMINALS.
5. DETAILS A AND B SHOW OPTIONAL CONSTRUCTIONS FOR TERMINALS.

MILLIMETERS		
DIM	MIN	MAX
A	0.80	1.00
A1	0.00	0.05
A3	0.20	REF
b	0.25	0.35
D	4.00	BSC
D2	1.91	2.21
E	4.00	BSC
E2	2.09	2.39
e	0.80	BSC
K	0.20	---
L	0.30	0.50
L1	---	0.15

SOLDERING FOOTPRINT*

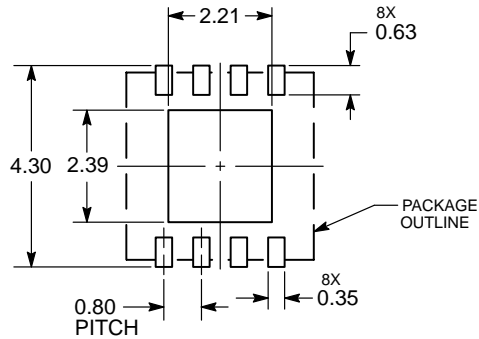

DIMENSIONS: MILLIMETERS

*For additional information on our Pb-Free strategy and soldering details, please download the ON Semiconductor Soldering and Mounting Techniques Reference Manual, SOLDERRM/D.

ON Semiconductor and are trademarks of Semiconductor Components Industries, LLC dba ON Semiconductor or its subsidiaries in the United States and/or other countries. ON Semiconductor owns the rights to a number of patents, trademarks, copyrights, trade secrets, and other intellectual property. A listing of ON Semiconductor's product/patent coverage may be accessed at www.onsemi.com/site/pdf/Patent-Marketing.pdf. ON Semiconductor reserves the right to make changes without further notice to any products herein. ON Semiconductor makes no warranty, representation or guarantee regarding the suitability of its products for any particular purpose, nor does ON Semiconductor assume any liability arising out of the application or use of any product or circuit, and specifically disclaims any and all liability, including without limitation special, consequential or incidental damages. Buyer is responsible for its products and applications using ON Semiconductor products, including compliance with all laws, regulations and safety requirements or standards, regardless of any support or applications information provided by ON Semiconductor. "Typical" parameters which may be provided in ON Semiconductor data sheets and/or specifications can and do vary in different applications and actual performance may vary over time. All operating parameters, including "Typicals" must be validated for each customer application by customer's technical experts. ON Semiconductor does not convey any license under its patent rights nor the rights of others. ON Semiconductor products are not designed, intended, or authorized for use as a critical component in life support systems or any FDA Class 3 medical devices or medical devices with a same or similar classification in a foreign jurisdiction or any devices intended for implantation in the human body. Should Buyer purchase or use ON Semiconductor products for any such unintended or unauthorized application, Buyer shall indemnify and hold ON Semiconductor and its officers, employees, subsidiaries, affiliates, and distributors harmless against all claims, costs, damages, and expenses, and reasonable attorney fees arising out of, directly or indirectly, any claim of personal injury or death associated with such unintended or unauthorized use, even if such claim alleges that ON Semiconductor was negligent regarding the design or manufacture of the part. ON Semiconductor is an Equal Opportunity/Affirmative Action Employer. This literature is subject to all applicable copyright laws and is not for resale in any manner.

PUBLICATION ORDERING INFORMATION

LITERATURE FULFILLMENT:

Literature Distribution Center for ON Semiconductor
19521 E. 32nd Pkwy, Aurora, Colorado 80011 USA
Phone: 303-675-2175 or 800-344-3860 Toll Free USA/Canada
Fax: 303-675-2176 or 800-344-3867 Toll Free USA/Canada
Email: orderlit@onsemi.com

N. American Technical Support: 800-282-9855 Toll Free
USA/Canada
Europe, Middle East and Africa Technical Support:
Phone: 421 33 790 2910

ON Semiconductor Website: www.onsemi.com

Order Literature: <http://www.onsemi.com/orderlit>

For additional information, please contact your local Sales Representative

Looking for pricing, stock, or lifecycle information?

Click below to explore more details on WIN SOURCE:

 [View NCV5662DSADJR4G on WIN SOURCE](#)

 [ON Semiconductor](#) Information

Optimize Your Supply Chain with WIN SOURCE Solutions

-  Global Sourcing Solution
-  Obsolete Management
-  Cost Control Management
-  Shortage Management
-  Alternative Solution
-  Excess Inventory Management