



**THE DATASHEET OF  
NCV8570BMN180R2G**



# NCV8570B

## 200 mA, Ultra Low Noise, High PSRR, LDO, Linear Voltage Regulator

The NCV8570B is a 200 mA Low Dropout, Linear Voltage Regulator with ultra low noise characteristics. It's low noise combined with high Power Supply Rejection Ratio (PSRR) make it especially suited for use in RF, audio or imaging applications. The device is manufactured in an advanced BiCMOS process to provide a powerful combination of low noise and excellent dynamic performance but with very low ground current consumption at full loads.

The NCV8570B is stable with small, low value capacitors allowing designers to minimise the total PCB space occupied by the solution. The device is packaged in a small 2x2.2mm DFN6 package as well as in a TSOP-5 package.

### Features

- Ultra Low Noise (typ. 10  $\mu$ Vrms @  $V_{OUT} = 1.8$  V)
- Very High PSRR (typ. 82 dB @ 1 kHz)
- Excellent Line and Load Regulation
- Stable with Ceramic Output Capacitors as low as 1  $\mu$ F
- Very Low Ground Current (typ. 75  $\mu$ A @  $I_{OUT} = 200$  mA)
- Low Sleep Mode Current (max. 1  $\mu$ A)
- Active Discharge Circuit
- Current Limit and Thermal Shutdown Protection
- Output Voltage Options:
  - ◆ 1.8 V, 2.5 V, 2.8 V, 3.0 V, 3.3 V
  - ◆ Contact Factory for Other Voltage Options
- NCV Prefix for Automotive and Other Applications Requiring Unique Site and Control Change Requirements; AEC-Q100 Qualified and PPAP Capable
- These are Pb-Free Devices

### Applications

- Satellite and HD Radio
- Portable/Built-in DVD Entertainment Systems
- Noise Sensitive Applications (RF, Video, Audio)
- GPS Systems
- Camera for Lane Change Detection and Reverse View

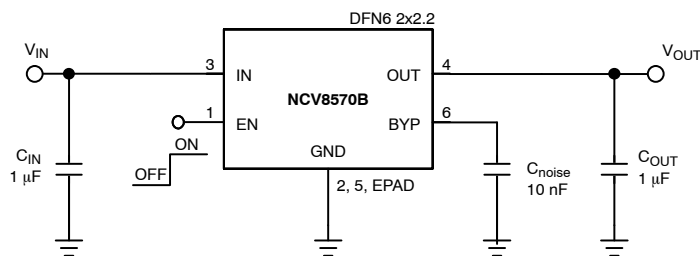

Figure 1. NCV8570B Typical Application Schematic



ON Semiconductor®

<http://onsemi.com>



DFN6  
MN SUFFIX  
CASE 506BA



TSOP-5  
SN SUFFIX  
CASE 483

### PIN CONNECTIONS

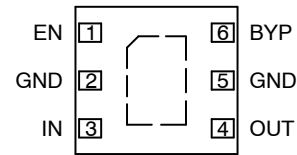

DFN6  
(Top View)

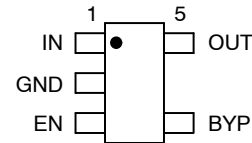

TSOP-5  
(Top View)

### MARKING DIAGRAMS

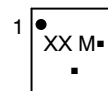

XX = Specific Device Code  
M = Date Code  
▪ = Pb-Free Package\*

(\*Note: Microdot may be in either location)

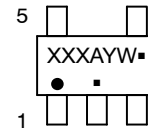

XXX = Specific Device Code  
A = Assembly Location  
Y = Year  
W = Work Week  
▪ = Pb-Free Package\*

(\*Note: Microdot may be in either location)

### ORDERING INFORMATION

See detailed ordering, marking and shipping information in the package dimensions section on page 18 of this data sheet.

# NCV8570B

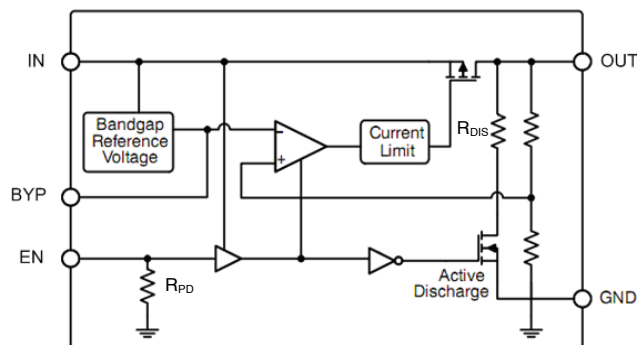

Figure 2. Simplified Block Diagram

## PIN FUNCTION DESCRIPTION

Pin No. DFN6	Pin No. TSOP-5	Pin Name	Description
1	3	EN	Enable pin: This pin allows on/off control of the regulator. To disable the device, connect to GND. If this function is not in use, connect to Vin. Internal 5 MΩ Pull Down resistor is connected between EN and GND.
2, 5, EPAD	2	GND	Power Supply Ground (Pins are fused for the DFN6 package). Pins 2, 5 and EPAD are connected together through the lead frame in the DFN6 package.
3	1	IN	Power Supply Input Voltage
4	5	OUT	Regulated Output Voltage
6	4	BYP	Noise reduction pin. (Connect 10 nF or 100 nF capacitor to GND)

## MAXIMUM RATINGS

Rating	Symbol	Value	Unit
Input Voltage (Note 2)	IN	-0.3 V to 6 V	V
Chip Enable Voltage	EN	-0.3 V to $V_{IN} + 0.3$ V	
Noise Reduction Voltage	BYP	-0.3 V to $V_{IN} + 0.3$ V	V
Output Voltage	OUT	-0.3 V to $V_{IN} + 0.3$ V	V
Output Short-Circuit Duration		Infinity	
Maximum Junction Temperature	$T_{J(max)}$	125	°C
Storage Temperature Range	$T_{STG}$	-55 to 150	°C

Stresses exceeding Maximum Ratings may damage the device. Maximum Ratings are stress ratings only. Functional operation above the Recommended Operating Conditions is not implied. Extended exposure to stresses above the Recommended Operating Conditions may affect device reliability.

- This device series contains ESD protection and exceeds the following tests:  
 Human Body Model 2000 V tested per MIL-STD-883, Method 3015  
 Machine Model Method 200 V  
 This device meets or exceeds AEC-Q100 standard.

## THERMAL CHARACTERISTICS

Rating	Symbol	Value	Unit
Package Thermal Resistance, DFN6: (Notes 2, 3) Junction-to-Case (Pin 2) Junction-to-Ambient	$\Psi_{JL2}$ $R_{\theta JA}$	38 110	°C/W
Package Thermal Resistance, TSOP-5: (Notes 2, 3) Junction-to-Case (Pin 2) Junction-to-Ambient	$\Psi_{JL2}$ $R_{\theta JA}$	92 204	°C/W

- Refer to APPLICATION INFORMATION for Safe Operating Area
- Single component mounted on 1 oz, FR4 PCB with 645mm<sup>2</sup> Cu area.

# NCV8570B

## ELECTRICAL CHARACTERISTICS

( $V_{IN} = V_{OUT} + 0.5\text{ V}$  or  $2.5\text{ V}$  (whichever is greater),  $V_{EN} = 1.2\text{ V}$ ,  $C_{IN} = C_{OUT} = 1\text{ }\mu\text{F}$ ,  $C_{noise} = 10\text{ nF}$ ,  $I_{OUT} = 1\text{ mA}$ ,  $T_J = -40^\circ\text{C}$  to  $125^\circ\text{C}$ , unless otherwise specified) (Note 4)

Parameter	Test Conditions	Symbol	Min	Typ	Max	Unit	
<b>REGULATOR OUTPUT</b>							
Input Voltage Range		$V_{IN}$	2.5	–	5.5	V	
Output Voltage	$V_{IN} = (V_{OUT} + 0.5\text{ V})$ to $5.5\text{ V}$ $I_{OUT} = 1\text{ mA}$ to $200\text{ mA}$	$V_{OUT}$	1.755 2.4375 2.730 2.925 3.2175 (-2.5%)	– – – – –	1.845 2.5625 2.870 3.075 3.3825 (+2.5%)	V	
Power Supply Ripple Rejection	$V_{IN} = V_{OUT} + 1.0\text{ V}$ , $I_{OUT} = 1\text{ mA}$ to $150\text{ mA}$	$f = 120\text{ Hz}$ $f = 1\text{ kHz}$ $f = 10\text{ kHz}$	PSRR	– – –	80 82 63	– – –	dB
Line Regulation	$V_{IN} = (V_{OUT} + 0.5\text{ V})$ to $5.5\text{ V}$ , $I_{OUT} = 1\text{ mA}$	$\Delta V_{OUT} / \Delta V_{IN}$	–0.1	–	0.1	%/V	
Load Regulation	$I_{OUT} = 1\text{ mA}$ to $200\text{ mA}$	$\Delta V_{OUT} / \Delta I_{OUT}$	–	0.2	5.0	mV	
Output Noise Voltage	$V_{OUT} = 1.8\text{ V}$ , $f = 10\text{ Hz}$ to $100\text{ kHz}$ , $I_{OUT} = 1\text{ mA}$ to $150\text{ mA}$	$C_{noise} = 100\text{ nF}$ $C_{noise} = 10\text{ nF}$	$V_N$	– –	10 15	– –	$\mu\text{V}_{RMS}$
Output Current Limit	$V_{OUT} = V_{OUT(NOM)} - 0.1\text{ V}$	$I_{LIM}$	200	310	470	mA	
Output Short Circuit Current	$V_{OUT} = 0\text{ V}$	$I_{SC}$	205	320	490	mA	
Dropout Voltage (Note 5)	$I_{OUT} = 150\text{ mA}$	$V_{OUT(NOM)} = 2.5\text{ V}$ $V_{OUT(NOM)} = 2.8\text{ V}$ $V_{OUT(NOM)} = 3.0\text{ V}$ $V_{OUT(NOM)} = 3.3\text{ V}$	$V_{DO}$	– – – –	100 90 85 80	180 165 150 145	mV
Dropout Voltage (Note 5)	$I_{OUT} = 200\text{ mA}$	$V_{OUT(NOM)} = 2.5\text{ V}$ $V_{OUT(NOM)} = 2.8\text{ V}$ $V_{OUT(NOM)} = 3.0\text{ V}$ $V_{OUT(NOM)} = 3.3\text{ V}$	$V_{DO}$	– – – –	140 120 115 110	230 205 190 185	mV

## GENERAL

Ground Current	$I_{OUT} = 1\text{ mA}$ $I_{OUT} = 200\text{ mA}$	$I_{GND}$	– –	70 75	110 130	$\mu\text{A}$
Disable Current	$V_{EN} = 0\text{ V}$	$I_{DIS}$	–	0.1	1.0	$\mu\text{A}$
Thermal Shutdown	Shutdown, Temperature Increasing	$T_{SDU}$	–	150	–	$^\circ\text{C}$
	Reset, Temperature Decreasing	$T_{SDD}$	–	135	–	$^\circ\text{C}$

## OUTPUT ENABLE

Enable Threshold	Low High	$V_{th(EN)}$	– 1.2	– –	0.4 –	V
Internal Pull-Down Resistance (Note 6)		$R_{PD(EN)}$	2.5	5.0	10	$\text{M}\Omega$

## TIMING

Turn-On Time	$I_{OUT} = 10\text{ mA}$ , $V_{OUT} = 0.975 V_{OUT(NOM)}$	$C_{noise} = 10\text{ nF}$ $C_{noise} = 100\text{ nF}$	$t_{ON}$	– –	0.4 4.0	– –	ms
Turn-Off Time	$C_{noise} = 10\text{ nF}/100\text{ nF}$ , $V_{OUT} = 0.1 V_{OUT(NOM)}$	$I_{OUT} = 1\text{ mA}$ $I_{OUT} = 10\text{ mA}$	$t_{OFF}$	– –	2.0 0.6	– –	ms

- Performance guaranteed over the indicated operating temperature range by design and/or characterization tested at  $T_J = T_A = 25^\circ\text{C}$ . Low duty cycle pulse techniques are used during testing to maintain the junction temperature as close to ambient as possible.
- Measured when the output voltage falls 100 mV below the nominal output voltage (nominal output voltage is the voltage at the output measured under the condition  $V_{IN} = V_{OUT} + 0.5\text{ V}$ ). In the case of devices having the nominal output voltage  $V_{OUT} = 1.8\text{ V}$  the minimum input to output voltage differential is given by the  $V_{IN(MIN)} = 2.5\text{ V}$ .
- Expected to disable the device when EN pin is floating.

# NCV8570B

## TYPICAL CHARACTERISTICS

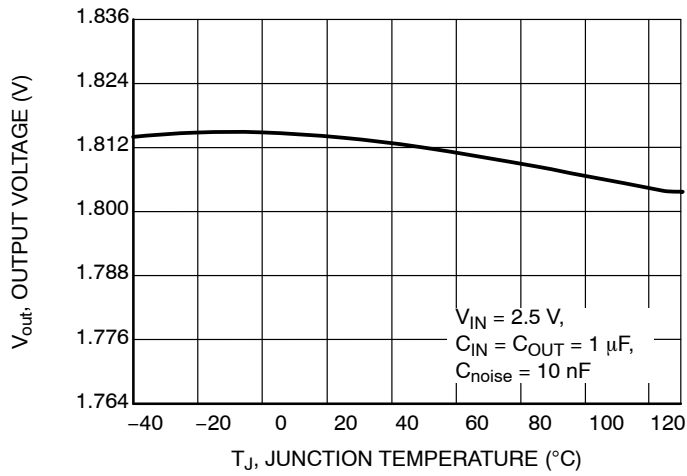

**Figure 3. Output Voltage vs. Junction Temperature,  $V_{OUT} = 1.8$  V**

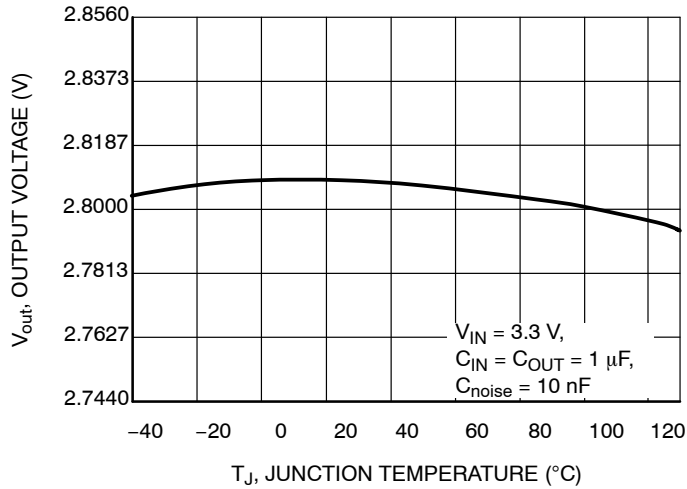

**Figure 4. Output Voltage vs. Junction Temperature,  $V_{OUT} = 2.8$  V**

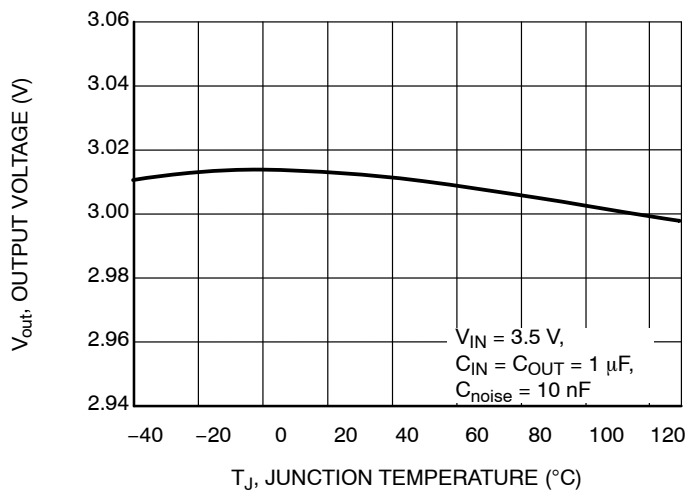

**Figure 5. Output Voltage vs. Junction Temperature,  $V_{OUT} = 3.0$  V**

TYPICAL CHARACTERISTICS

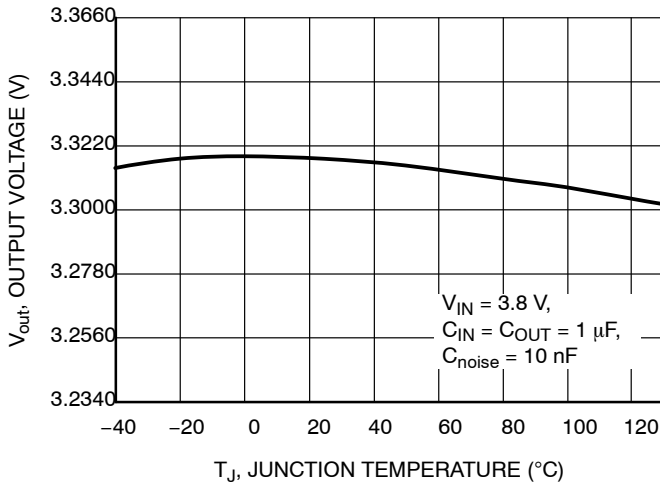

Figure 6. Output Voltage vs. Junction Temperature,  $V_{OUT} = 3.3\text{ V}$

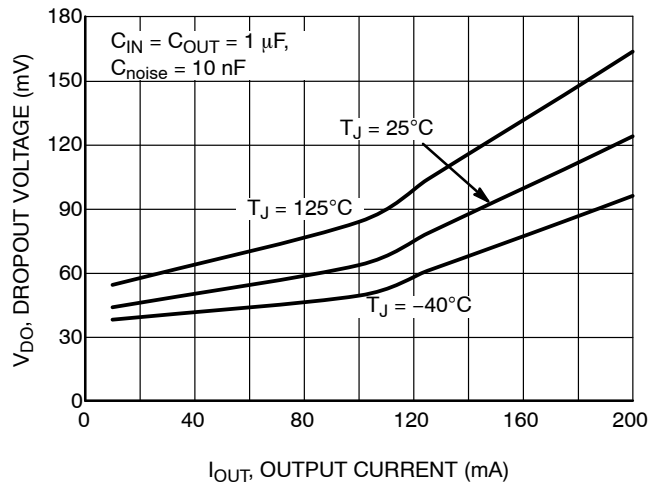

Figure 7. Dropout Voltage vs. Output Current,  $V_{OUT} = 2.8\text{ V}$

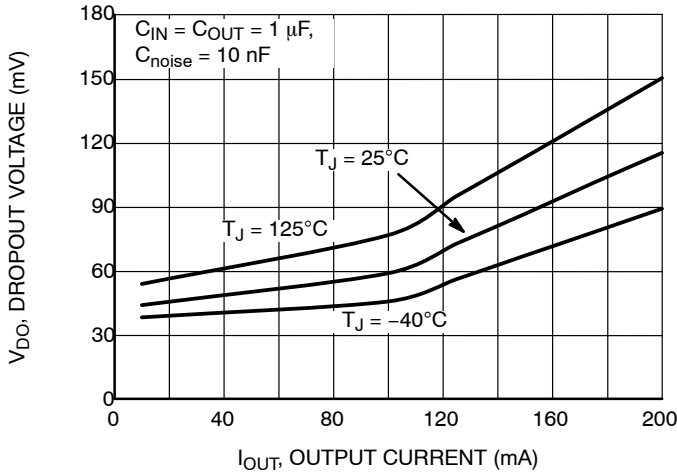

Figure 8. Dropout Voltage vs. Output Current,  $V_{OUT} = 3.0\text{ V}$

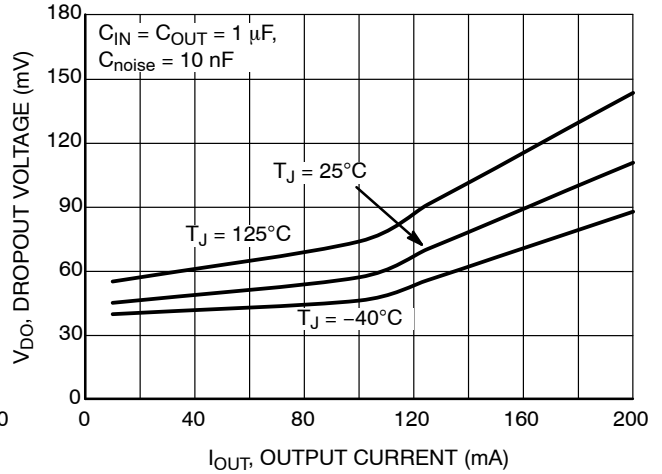

Figure 9. Dropout Voltage vs. Output Current,  $V_{OUT} = 3.3\text{ V}$

TYPICAL CHARACTERISTICS

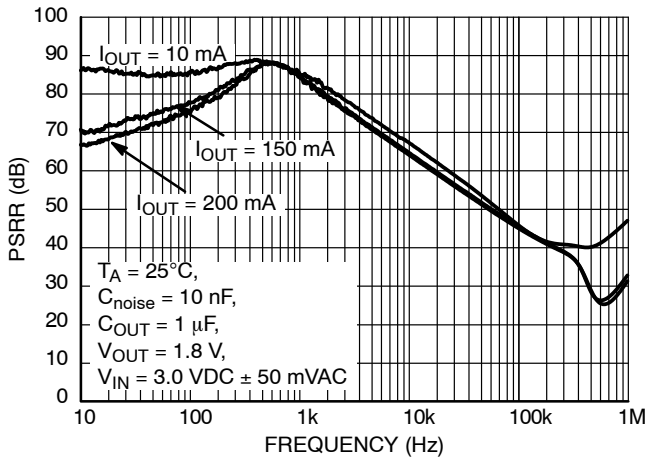

Figure 10. PSRR vs. Frequency, 1.8 V Output Voltage Option,  $C_{OUT} = 1 \mu F$ ,  $C_{noise} = 10 nF$

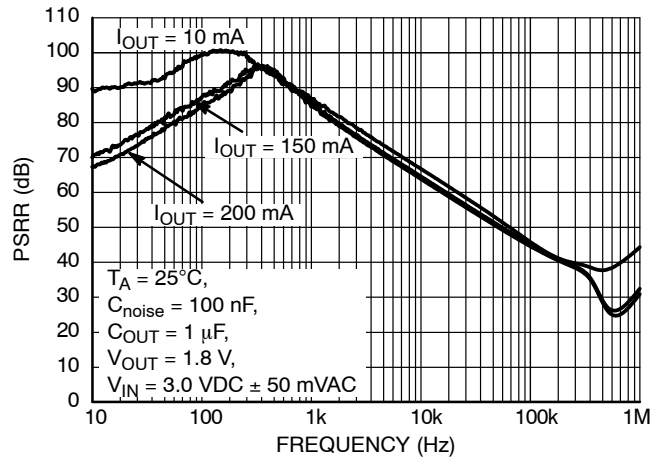

Figure 11. PSRR vs. Frequency, 1.8 V Output Voltage Option,  $C_{OUT} = 1 \mu F$ ,  $C_{noise} = 100 nF$

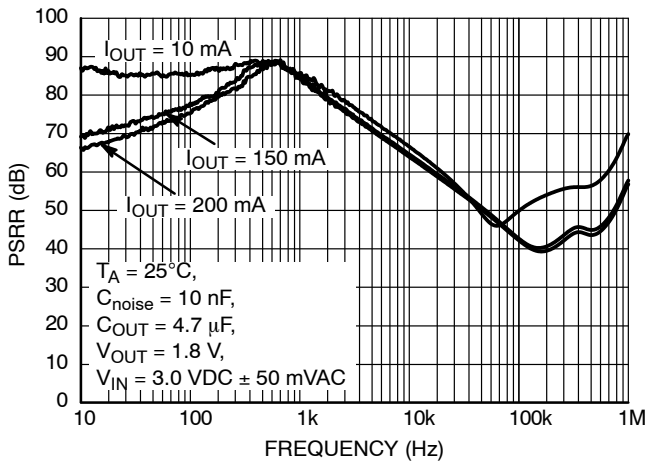

Figure 12. PSRR vs. Frequency, 1.8 V Output Voltage Option,  $C_{OUT} = 4.7 \mu F$ ,  $C_{noise} = 10 nF$

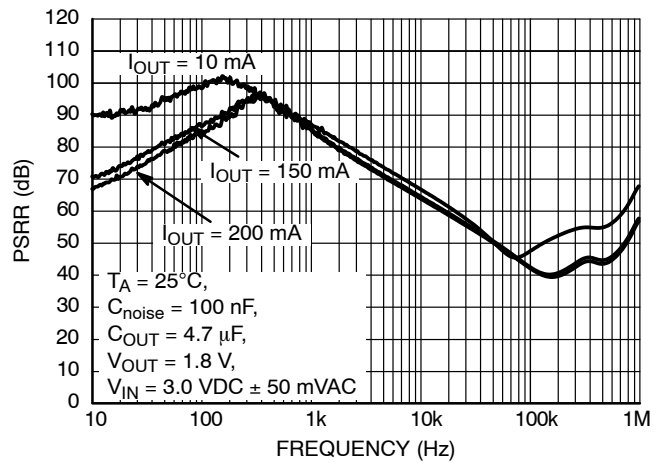

Figure 13. PSRR vs. Frequency, 1.8 V Output Voltage Option,  $C_{OUT} = 4.7 \mu F$ ,  $C_{noise} = 100 nF$

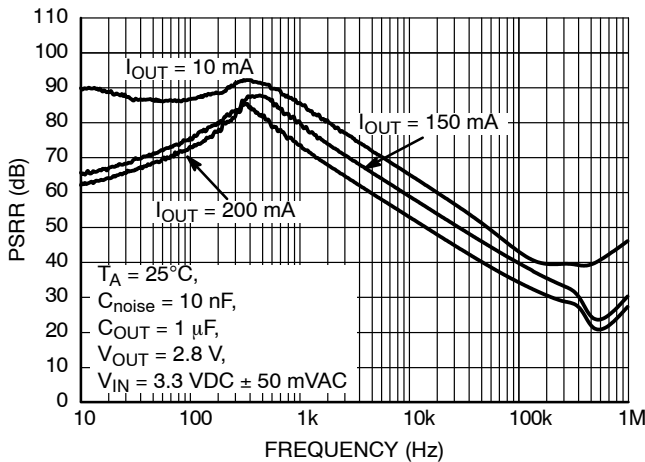

Figure 14. PSRR vs. Frequency, 2.8 V Output Voltage Option,  $C_{OUT} = 1 \mu F$ ,  $C_{noise} = 10 nF$

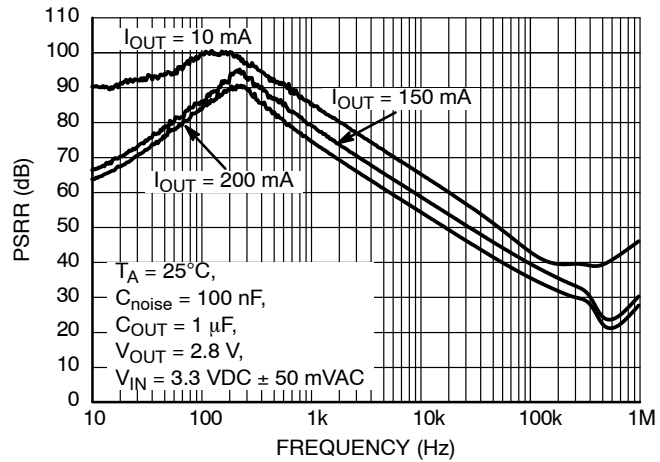

Figure 15. PSRR vs. Frequency, 2.8 V Output Voltage Option,  $C_{OUT} = 1 \mu F$ ,  $C_{noise} = 100 nF$

TYPICAL CHARACTERISTICS

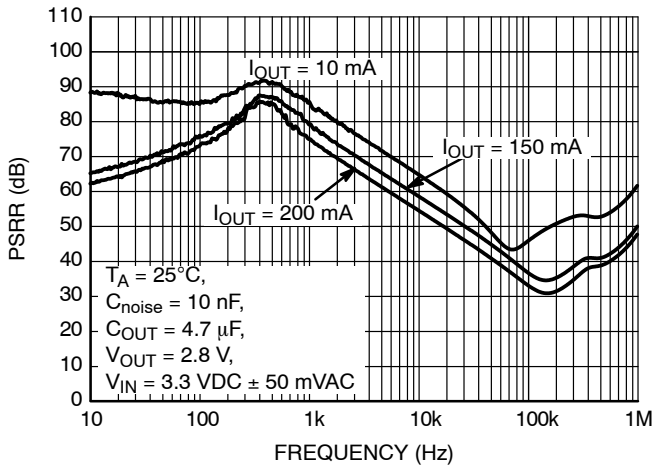

Figure 16. PSRR vs. Frequency, 2.8 V Output Voltage Option,  $C_{OUT} = 4.7 \mu F$ ,  $C_{noise} = 10 nF$

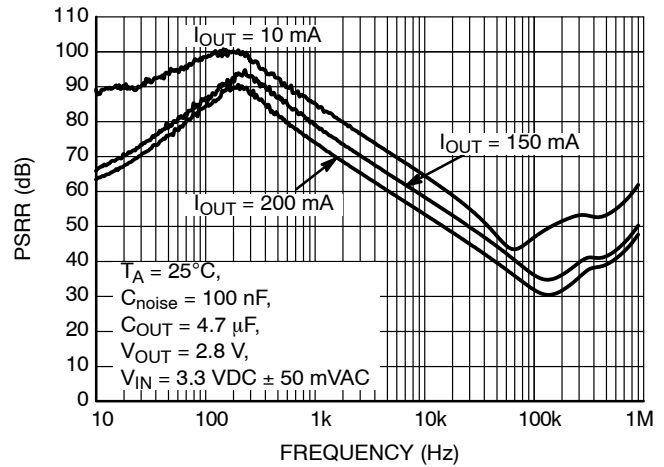

Figure 17. PSRR vs. Frequency, 2.8 V Output Voltage Option,  $C_{OUT} = 4.7 \mu F$ ,  $C_{noise} = 100 nF$

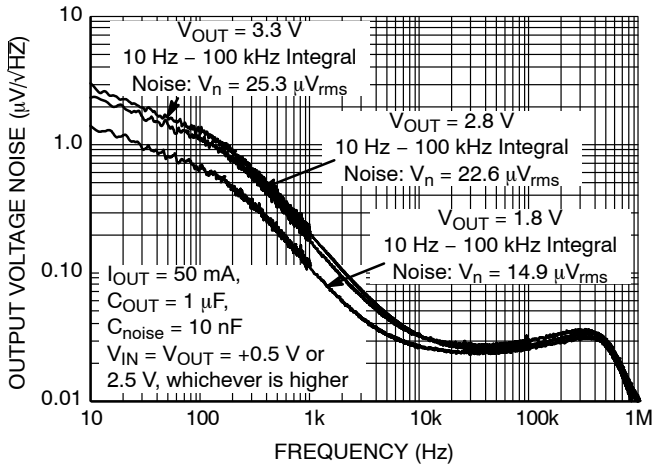

Figure 18. Output Noise vs. Frequency,  $C_{OUT} = 1 \mu F$ ,  $C_{noise} = 10 nF$ ,  $I_{OUT} = 50 mA$

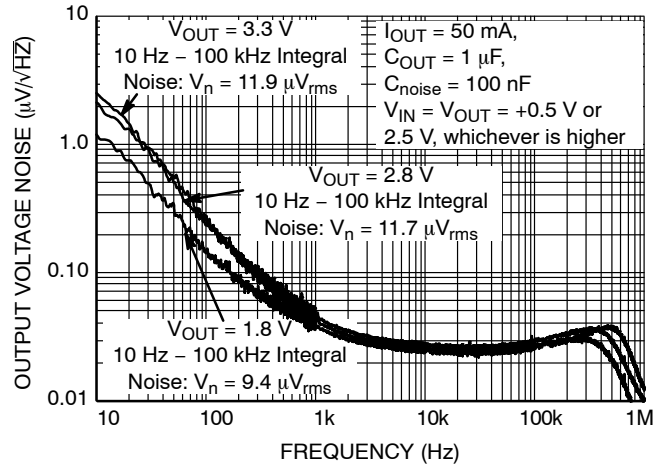

Figure 19. Output Noise vs. Frequency,  $C_{OUT} = 1 \mu F$ ,  $C_{noise} = 100 nF$ ,  $I_{OUT} = 50 mA$

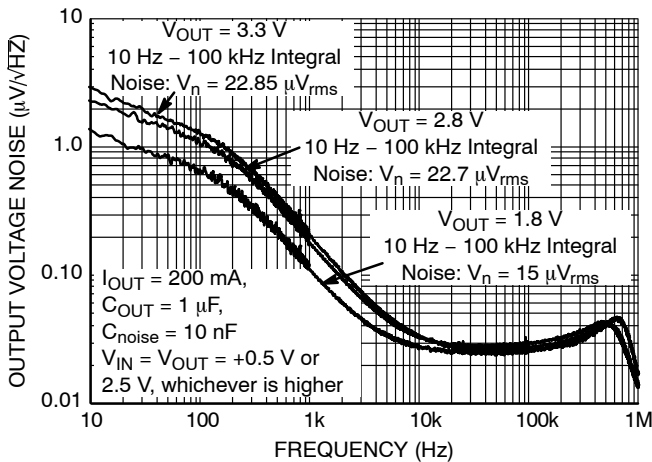

Figure 20. Output Noise vs. Frequency,  $C_{OUT} = 1 \mu F$ ,  $C_{noise} = 10 nF$ ,  $I_{OUT} = 200 mA$

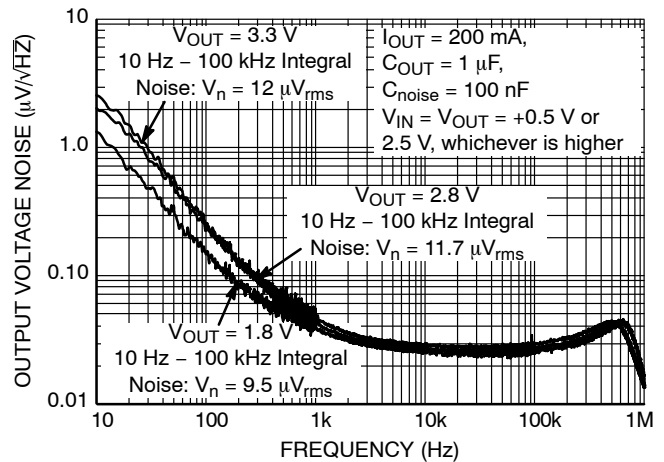
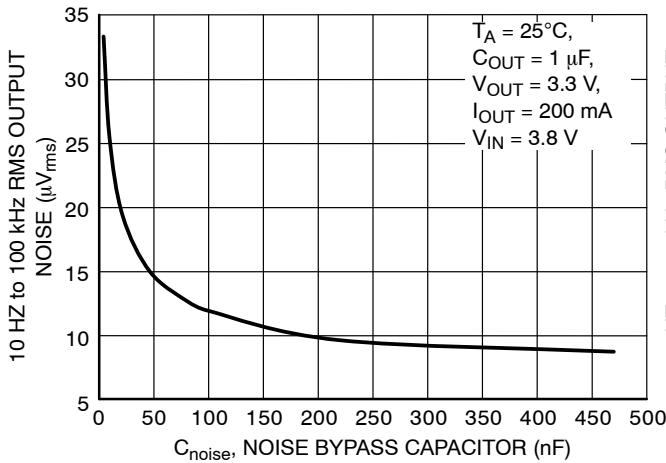
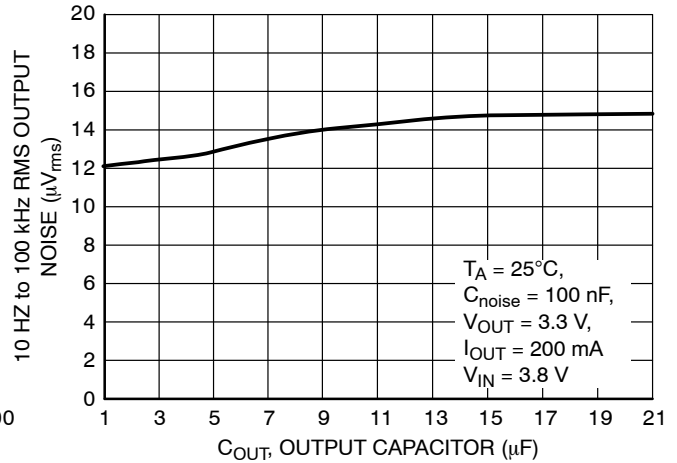

Figure 21. Output Noise vs. Frequency,  $C_{OUT} = 1 \mu F$ ,  $C_{noise} = 100 nF$ ,  $I_{OUT} = 200 mA$

TYPICAL CHARACTERISTICS



**Figure 22. Output Noise vs. Noise Bypass Capacitance,  $C_{OUT} = 1 \mu F$ ,  $V_{OUT} = 3.3 V$ ,  $I_{OUT} = 200 mA$**



**Figure 23. Output Noise vs. Output Capacitance,  $C_{noise} = 100 nF$ ,  $V_{OUT} = 3.3 V$ ,  $I_{OUT} = 200 mA$**

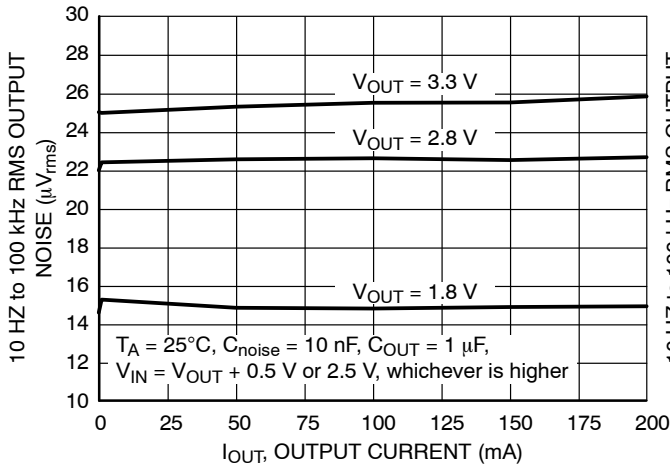

**Figure 24. Output Noise vs. Load Current,  $C_{noise} = 10 nF$ ,  $C_{OUT} = 1 \mu F$**

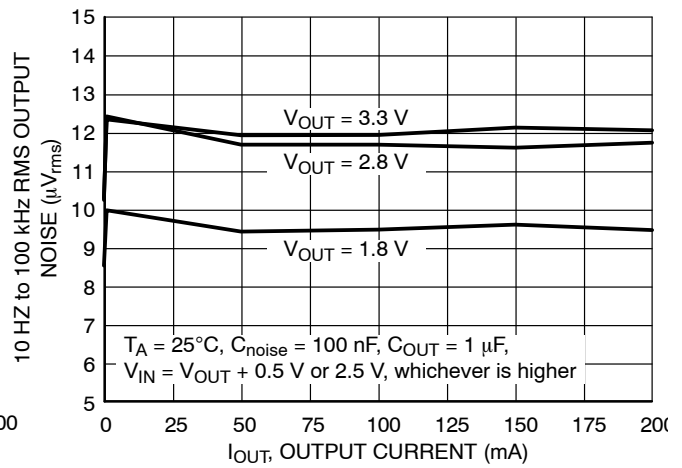

**Figure 25. Output Noise vs. Load Current,  $C_{noise} = 100 nF$ ,  $C_{OUT} = 1 \mu F$**

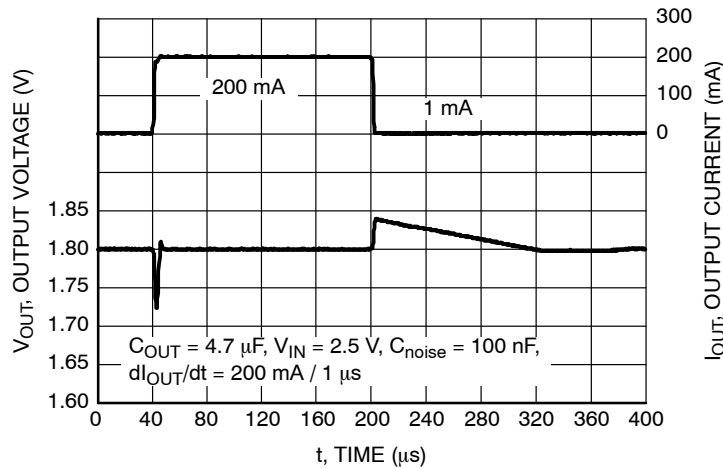

**Figure 26. Load Transient Response,  $V_{OUT} = 1.8 V$ ,  $C_{OUT} = 4.7 \mu F$ ,  $C_{noise} = 100 nF$**

# NCV8570B

## TYPICAL CHARACTERISTICS

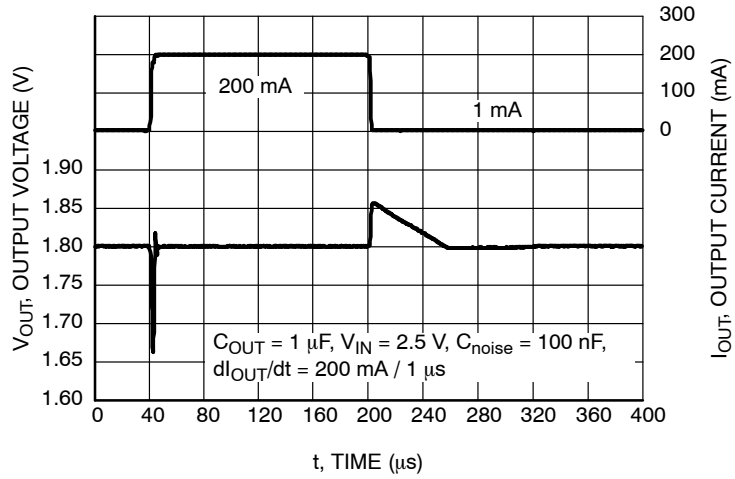

**Figure 27. Load Transient Response,  $V_{OUT} = 1.8 \text{ V}$ ,  $C_{OUT} = 1 \mu\text{F}$ ,  $C_{noise} = 100 \text{ nF}$**

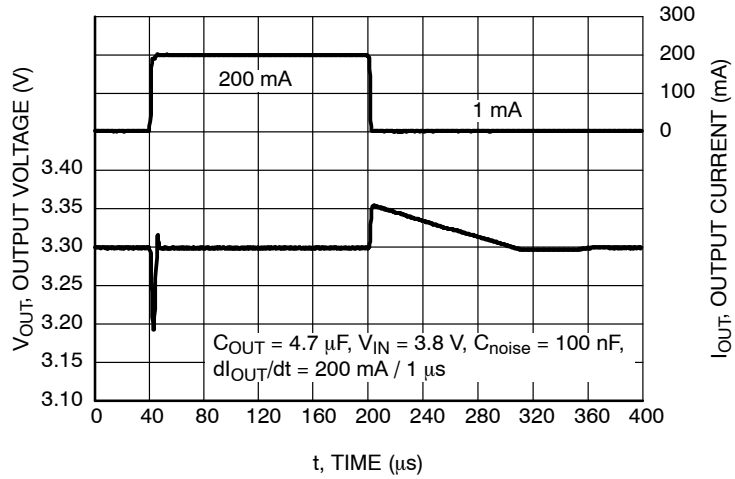

**Figure 28. Load Transient Response,  $V_{OUT} = 3.3 \text{ V}$ ,  $C_{OUT} = 4.7 \mu\text{F}$ ,  $C_{noise} = 100 \text{ nF}$**

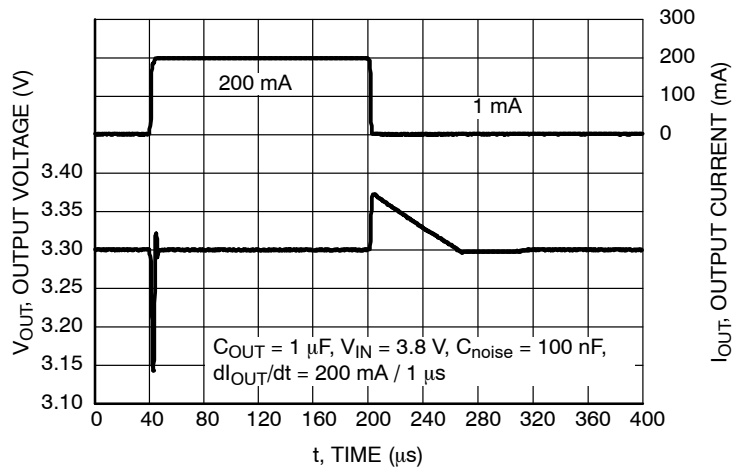

**Figure 29. Load Transient Response,  $V_{OUT} = 3.3 \text{ V}$ ,  $C_{OUT} = 1 \mu\text{F}$ ,  $C_{noise} = 100 \text{ nF}$**

# NCV8570B

## TYPICAL CHARACTERISTICS

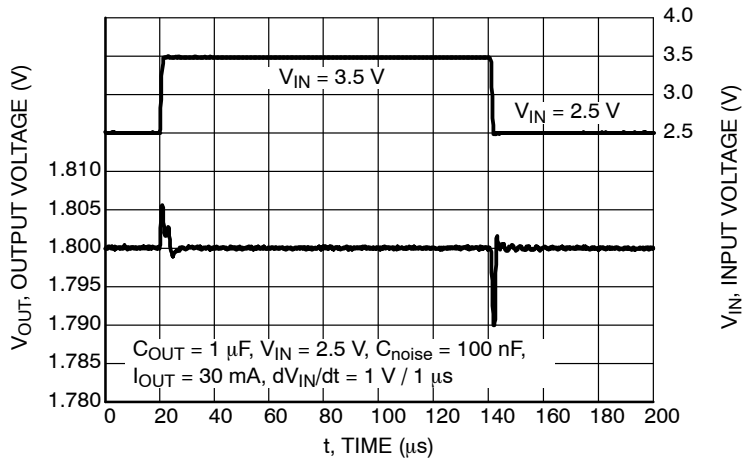

**Figure 30. Line Transient Response,  
 $V_{OUT} = 1.8 \text{ V}$ ,  $C_{OUT} = 1 \mu\text{F}$ ,  $I_{OUT} = 30 \text{ mA}$**

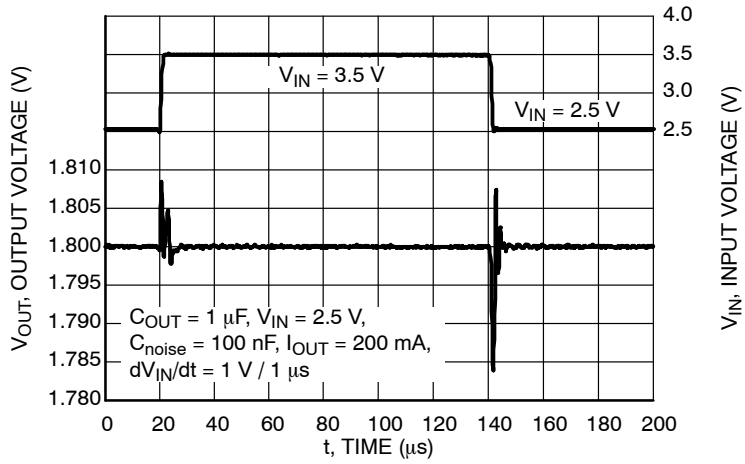

**Figure 31. Line Transient Response,  
 $V_{OUT} = 1.8 \text{ V}$ ,  $C_{OUT} = 1 \mu\text{F}$ ,  $I_{OUT} = 200 \text{ mA}$**

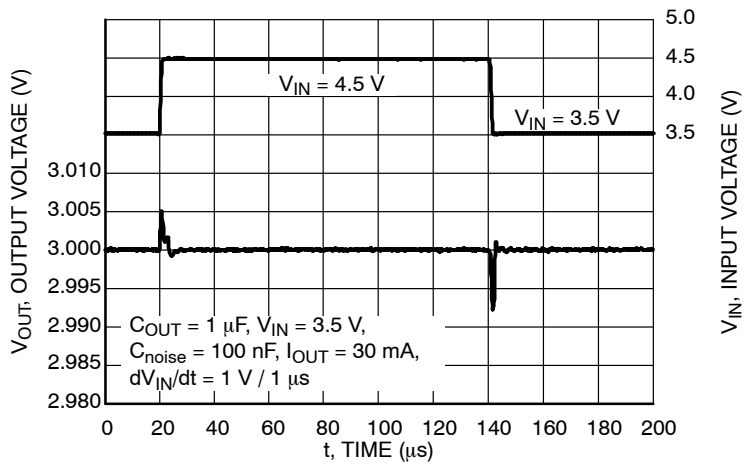

**Figure 32. Line Transient Response,  
 $V_{OUT} = 3.0 \text{ V}$ ,  $C_{OUT} = 1 \mu\text{F}$ ,  $I_{OUT} = 30 \text{ mA}$**

# NCV8570B

## TYPICAL CHARACTERISTICS

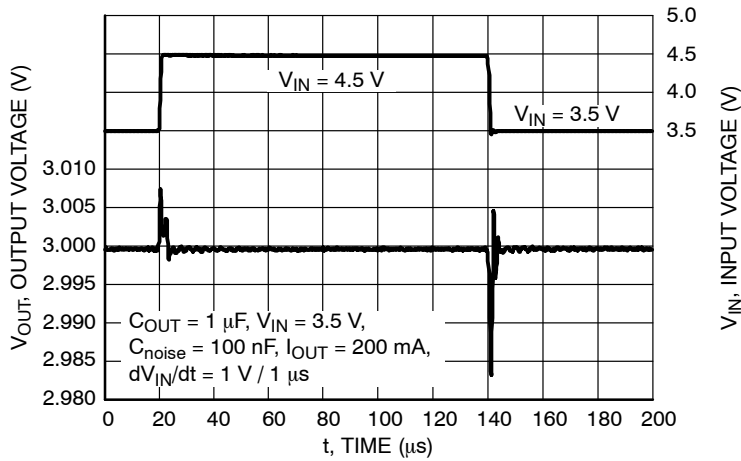

**Figure 33. Line Transient Response,**  
 $V_{OUT} = 3.0 V$ ,  $C_{OUT} = 1 \mu F$ ,  $I_{OUT} = 200 mA$

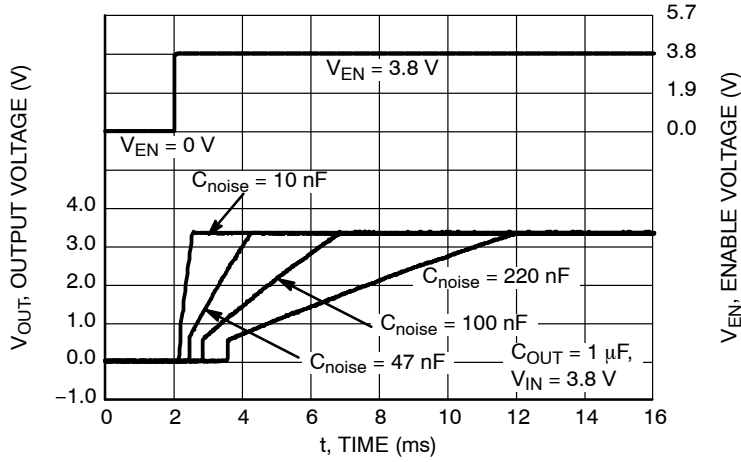

**Figure 34. Turn-On Response**  
 $V_{OUT} = 3.3 V$ ,  $C_{OUT} = 1 \mu F$ ,  $I_{OUT} = 30 mA$

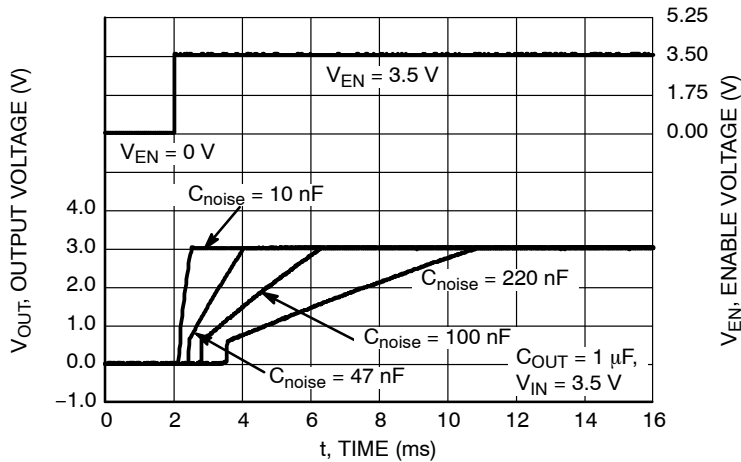

**Figure 35. Turn-On Response**  
 $V_{OUT} = 3 V$ ,  $C_{OUT} = 1 \mu F$ ,  $I_{OUT} = 30 mA$

# NCV8570B

## TYPICAL CHARACTERISTICS

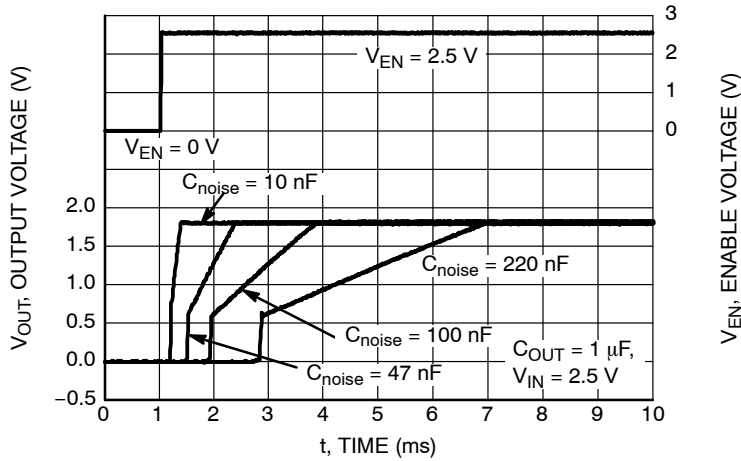

**Figure 36. Turn-On Response**  
 $V_{OUT} = 1.8$  V,  $C_{OUT} = 1 \mu F$ ,  $I_{OUT} = 30$  mA

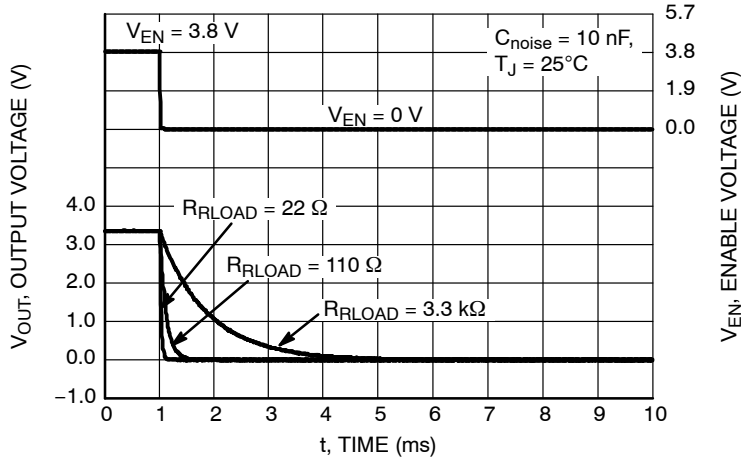

**Figure 37. Turn-Off Response**  
 $V_{OUT} = 3.3$  V,  $C_{OUT} = 1 \mu F$

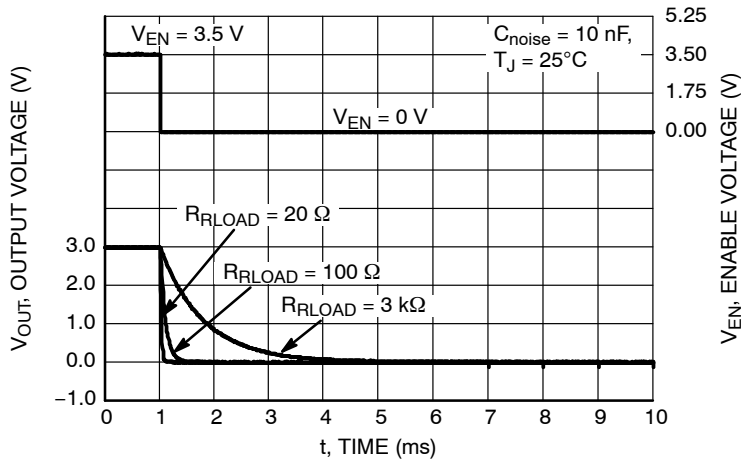

**Figure 38. Turn-Off Response**  
 $V_{OUT} = 3$  V,  $C_{OUT} = 1 \mu F$

TYPICAL CHARACTERISTICS

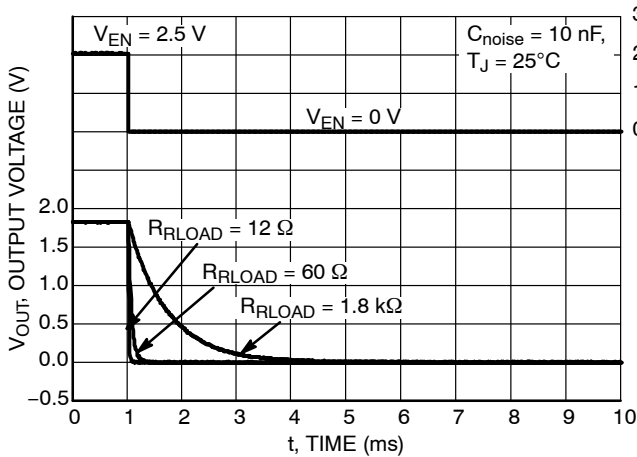

Figure 39. Turn-Off Response  
 $V_{OUT} = 1.8 \text{ V}$ ,  $C_{OUT} = 1 \mu\text{F}$

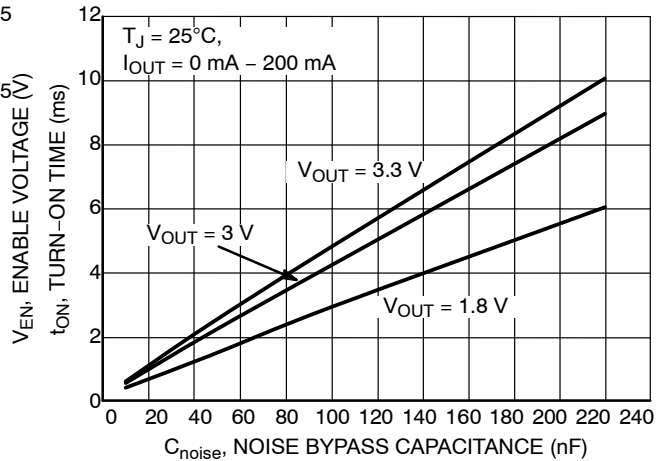

Figure 40. Turn-On Time vs. Noise Bypass Capacitance,  $C_{OUT} = 1 \mu\text{F}$ ,  $I_{OUT} = 0 \text{ mA} - 200 \text{ mA}$

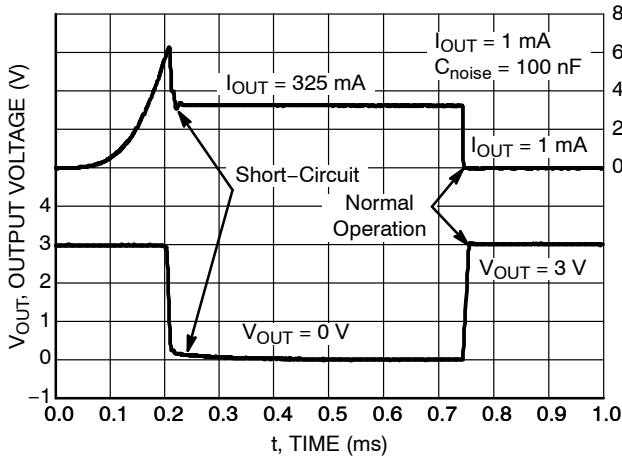

Figure 41. Short-Circuit Protection,  
 $V_{OUT} = 3 \text{ V}$ ,  $C_{OUT} = 1 \mu\text{F}$ ,  $C_{noise} = 100 \text{ nF}$

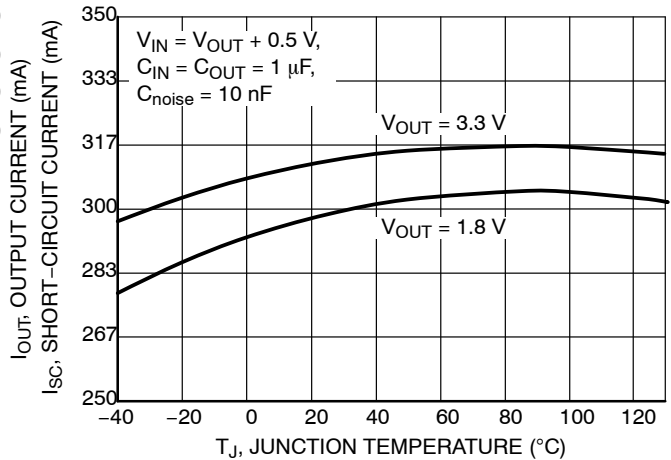

Figure 42. Short-Circuit Current vs. Junction Temperature,  $V_{OUT} = 1.8 \text{ V}$ ,  $3.3 \text{ V}$

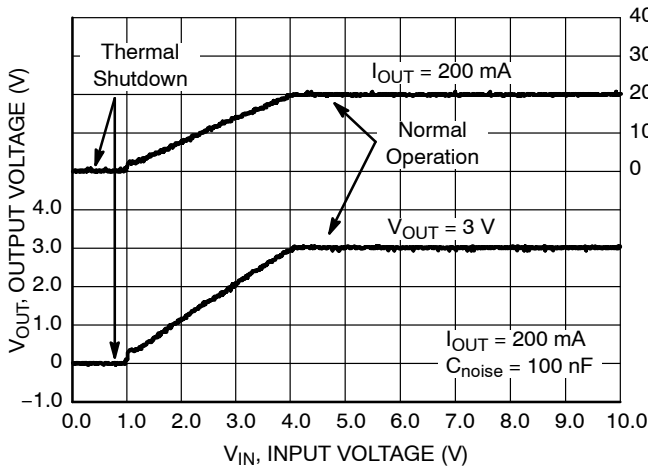

Figure 43. Thermal Shutdown Protection  
 $V_{OUT} = 3 \text{ V}$ ,  $C_{noise} = 100 \text{ nF}$ ,  $C_{OUT} = 1 \mu\text{F}$

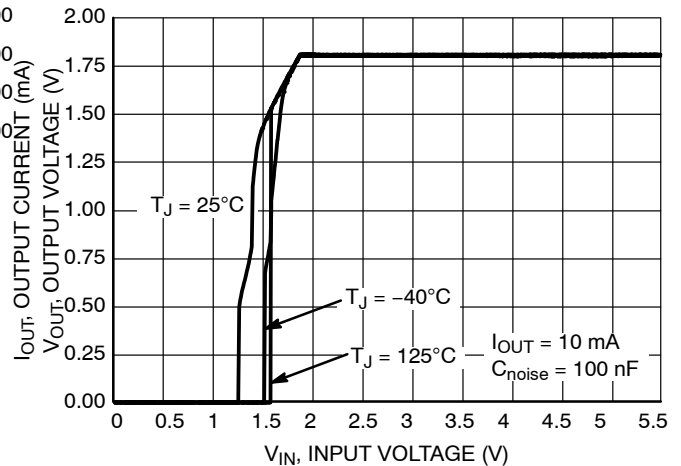

Figure 44. Output Voltage vs. Input Voltage,  
 $V_{OUT} = 1.8 \text{ V}$ ,  $C_{OUT} = 1 \mu\text{F}$

TYPICAL CHARACTERISTICS

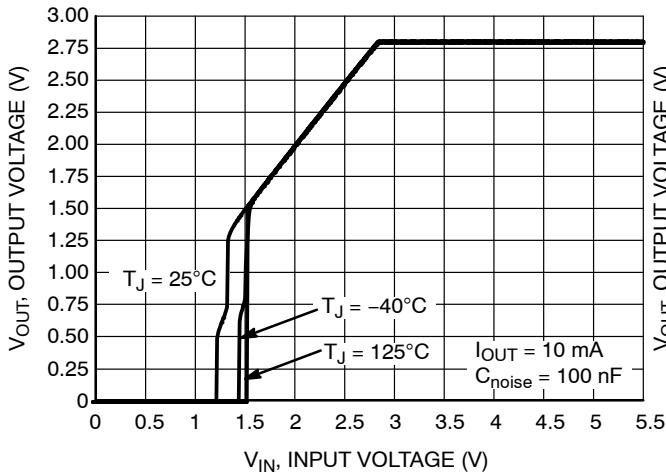

Figure 45. Output Voltage vs. Input Voltage,  $V_{OUT} = 2.8\text{ V}$ ,  $C_{OUT} = 1\ \mu\text{F}$

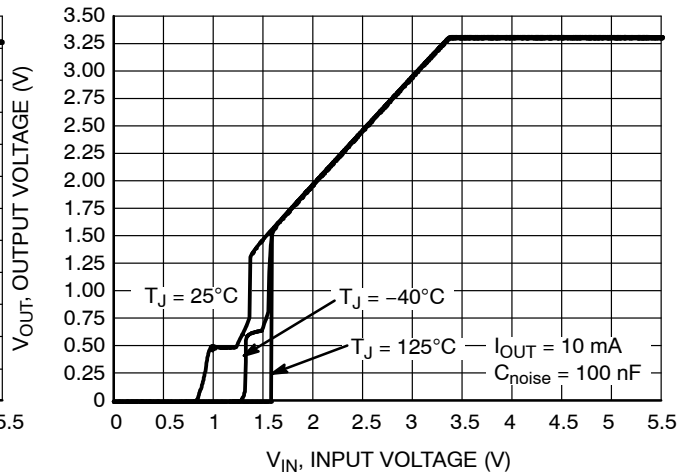

Figure 46. Output Voltage vs. Input Voltage,  $V_{OUT} = 3.3\text{ V}$ ,  $C_{OUT} = 1\ \mu\text{F}$

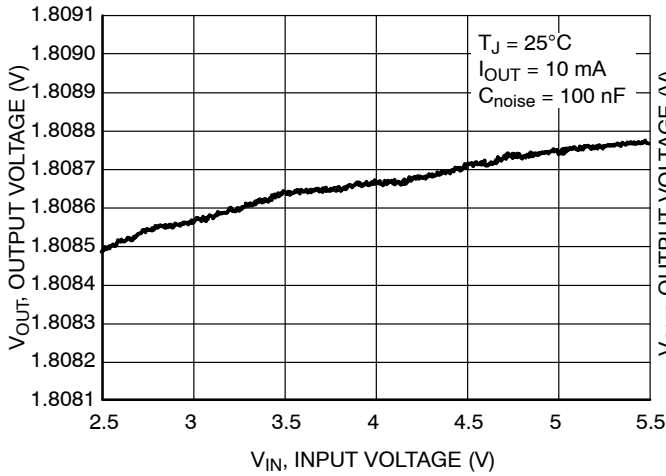

Figure 47. Output Voltage vs. Input Voltage,  $V_{OUT} = 1.8\text{ V}$ ,  $C_{OUT} = 1\ \mu\text{F}$

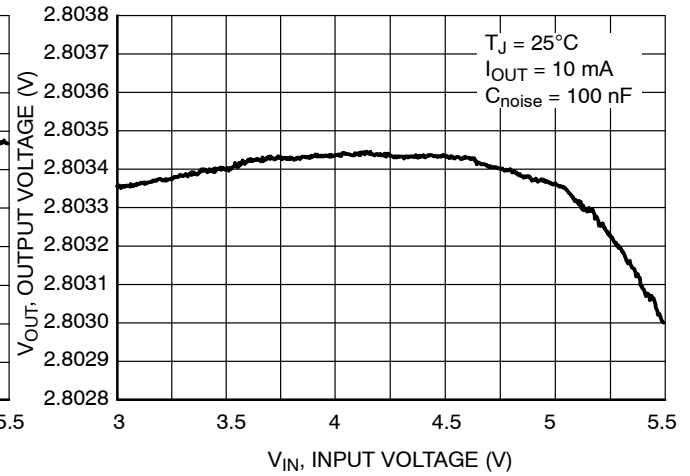

Figure 48. Output Voltage vs. Input Voltage,  $V_{OUT} = 2.8\text{ V}$ ,  $C_{OUT} = 1\ \mu\text{F}$

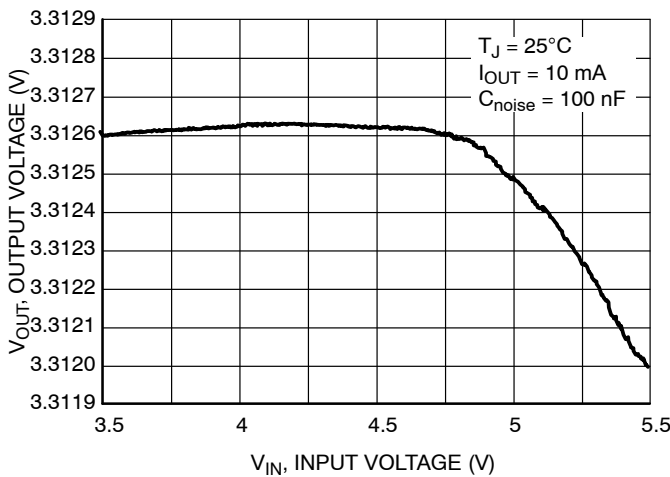

Figure 49. Output Voltage vs. Input Voltage,  $V_{OUT} = 3.3\text{ V}$ ,  $C_{OUT} = 1\ \mu\text{F}$

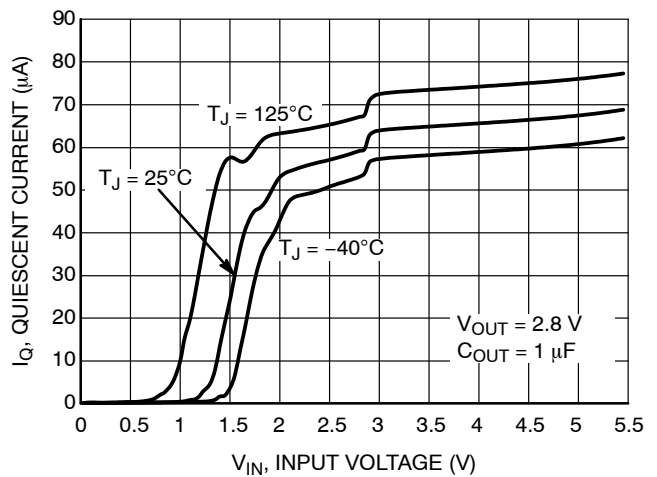

Figure 50. Quiescent Current vs. Input Voltage,  $V_{OUT} = 2.8\text{ V}$ ,  $C_{OUT} = 1\ \mu\text{F}$

TYPICAL CHARACTERISTICS

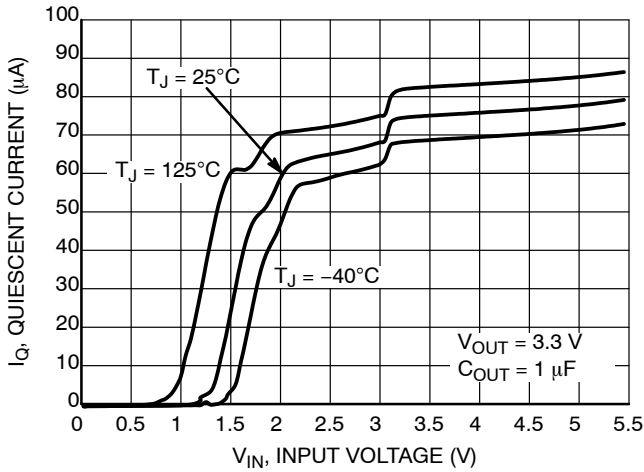

Figure 51. Quiescent Current vs. Input Voltage,  $V_{OUT} = 3.3\text{ V}$ ,  $C_{OUT} = 1\ \mu\text{F}$

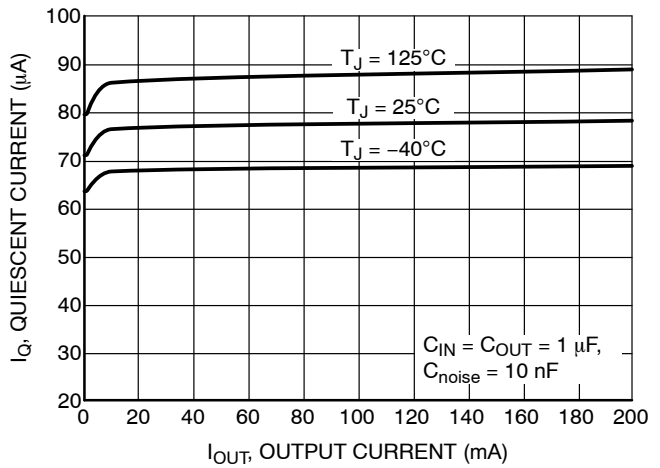

Figure 52. Quiescent Current vs. Output Current,  $V_{OUT} = 3.3\text{ V}$

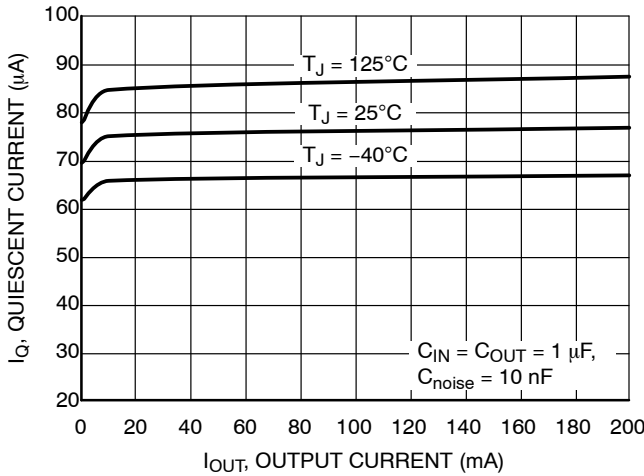

Figure 53. Quiescent Current vs. Output Current,  $V_{OUT} = 3.0\text{ V}$

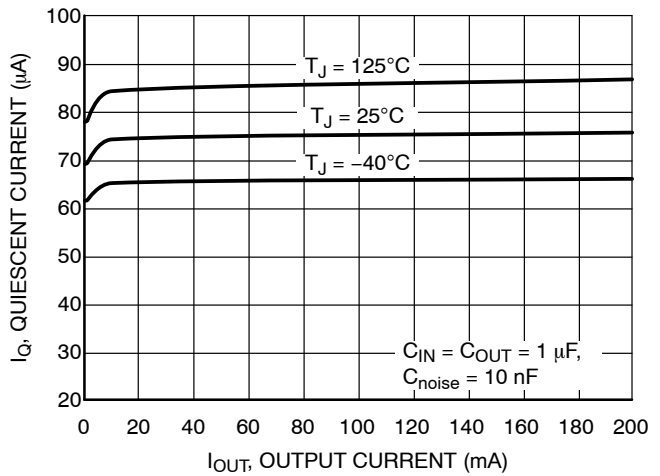

Figure 54. Quiescent Current vs. Output Current,  $V_{OUT} = 2.8\text{ V}$

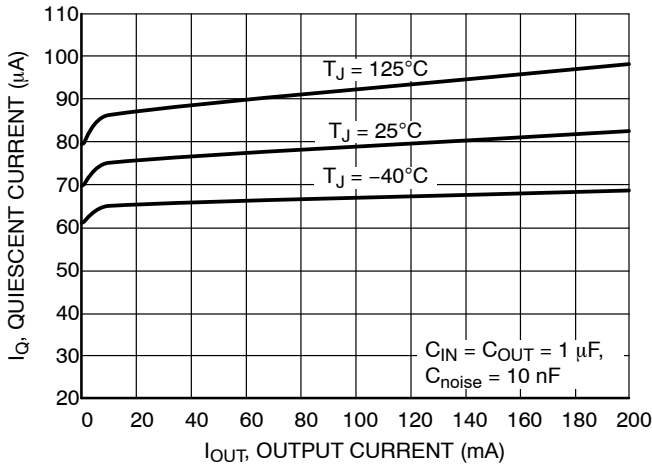

Figure 55. Quiescent Current vs. Output Current,  $V_{OUT} = 1.8\text{ V}$

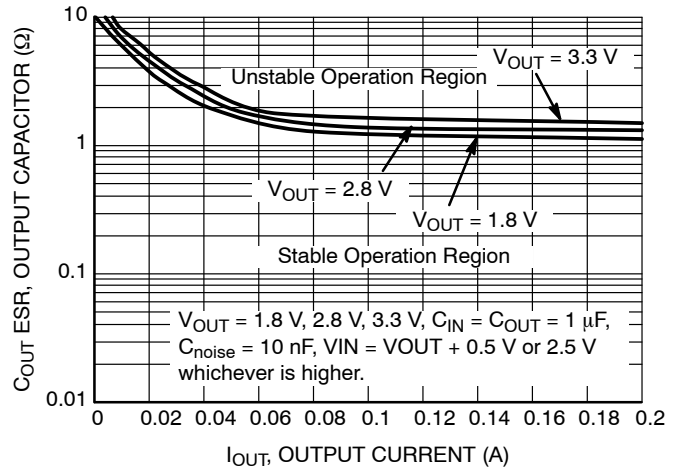

Figure 56. Output Capacitor ESR vs. Output Current

APPLICATIONS INFORMATION

**General**

The NCV8570B is a high performance 200 mA low dropout linear regulator. This device delivers excellent noise and dynamic performance consuming only 75  $\mu$ A (typ) quiescent current at full load, with the PSRR of (typ) 82 dB at 1 kHz. Excellent load transient performance and small package size makes the device ideal for portable applications.

Logic EN input provides ON/OFF control of the output voltage. When the EN is low the device consumes as low as typically 0.1  $\mu$ A.

Access to the major contributor of noise within the integrated circuit – Bandgap Reference is provided through the BYP pin. This allows bypassing the source of noise by the noise reduction capacitor and reaching noise levels below 10  $\mu$ V<sub>RMS</sub>.

The device is fully protected in case of output short circuit condition and overheating assuring a very robust design.

**Input Capacitor Requirements (C<sub>IN</sub>)**

It is recommended to connect a 1  $\mu$ F ceramic capacitor between IN pin and GND pin of the device. This capacitor will provide a low impedance path for unwanted AC signals or noise present on the input voltage. The input capacitor will also limit the influence of input trace inductances and Power Supply resistance during sudden load current changes. Higher capacitances will improve the line transient response.

**Output Capacitor Requirements (C<sub>OUT</sub>)**

The NCV8570B has been designed to work with low ESR ceramic capacitors on the output. The device will also work with other types of capacitors until the minimum value of capacitance is assured and the capacitor ESR is within the specified range. Generally it is recommended to use 1  $\mu$ F or larger X5R or X7R ceramic capacitor on the output pin.

**Noise Bypass Capacitor Requirements (C<sub>noise</sub>)**

The C<sub>noise</sub> capacitor is connected directly to the high impedance node. Any loading on this pin like the connection of oscilloscope probe, or the C<sub>noise</sub> capacitor leakage will cause a voltage drop in regulated output voltage. The minimum recommended value of noise bypass capacitor is 10 nF. Values below 10 nF should be avoided due to possible Turn-On overshoot. Particular value should be chosen based on the output noise requirements (Figure 22). Larger values of C<sub>noise</sub> will improve the output noise and PSRR but will increase the regulator Turn-On time.

**Enable Operation**

The enable function is controlled by the logic pin EN. The voltage threshold of this pin is set between 0.4 V and 1.2 V. Voltage lower than 0.4 V guarantees the device is off. Voltage higher than 1.2 V guarantees the device is on. The NCV8570B enters a sleep mode when in the off state drawing less than typically 0.1  $\mu$ A of quiescent current. The

internal 5 M $\Omega$  pull-down resistor (R<sub>PD</sub>) assures that the device is turned off when EN pin is not connected.

The device can be used as a simple regulator without use of the chip enable feature by tying the EN to the IN pin.

**Active Discharge**

Active discharge circuitry has been implemented to insure a fast V<sub>OUT</sub> turn off time. When EN goes low, the active discharge transistor turns on creating a path to discharge the output capacitor C<sub>OUT</sub> through 1 k $\Omega$  (R<sub>DIS</sub>) resistor.

**Turn-On Time**

The Turn-On time of the regulator is defined as the time needed to reach the output voltage which is 98% V<sub>OUT</sub> after assertion of the EN pin. This time is determined by the noise bypass capacitance C<sub>noise</sub> and nominal output voltage level V<sub>OUT</sub> according the following formula:

$$t_{ON} [s] = C_{noise} [F] \cdot \frac{V_{OUT} [V]}{68 \cdot 10^{-6} [A]} \quad (eq. 1)$$

Example:

Using C<sub>noise</sub> = 100 nF, V<sub>OUT</sub> = 3 V, C<sub>OUT</sub> = 1  $\mu$ F,

$$t_{ON} = 100 \cdot 10^{-9} \cdot \frac{3}{68 \cdot 10^{-6}} = 4.41 \text{ ms}$$

The Turn-On time is independent of the load current and output capacitor C<sub>OUT</sub>. To avoid output voltage overshoot during Turn-On please select C<sub>noise</sub>  $\geq$  10 nF.

**Current Limit**

Output Current is internally limited within the IC to a typical 310 mA. The NCV8570B will source this amount of current measured with a voltage 100 mV lower than the typical operating output voltage. If the Output Voltage is directly shorted to ground (V<sub>OUT</sub> = 0 V), the short circuit protection will limit the output current to 320 mA (typ). The current limit and short circuit protection will work properly up to V<sub>IN</sub> = 5.5 V at T<sub>A</sub> = 25°C. There is no limitation for the short circuit duration.

**Thermal Shutdown**

When the die temperature exceeds the Thermal Shutdown threshold (T<sub>SDU</sub> – 150°C typical), Thermal Shutdown event is detected and the output (V<sub>OUT</sub>) is turned off.

The IC will remain in this state until the die temperature decreases below the Thermal Shutdown Reset threshold (T<sub>SDU</sub> – 135°C typical). Once the IC temperature falls below the 135°C the LDO is turned-on again.

The thermal shutdown feature provides the protection from a catastrophic device failure due to accidental overheating. This protection is not intended to be used as a substitute for proper heat sinking.

**Reverse Current**

The PMOS pass transistor has an inherent body diode which will conduct the current in case that the V<sub>OUT</sub> > V<sub>IN</sub>.

Such condition could exist in the case of pulling the  $V_{IN}$  voltage to ground. Then the output capacitor voltage will be partially discharged through the PMOS body diode. It has been verified that the device will not be damaged if the output capacitance is less than 22  $\mu\text{F}$ . If however larger output capacitors are used or extended reverse current condition is anticipated the device may require additional external protection against the excessive reverse current.

**Output Noise**

If we neglect the noise coming from the (IN) input pin of the LDO, the main contributor of noise present on the output pin (OUT) is the internal bandgap reference. This is because any noise which is generated at this node will be subsequently amplified through the error amplifier and the PMOS pass device. Access to the bandgap reference node is supplied through the BYP pin. For the 1.8 V output voltage option Noise can be reduced from a typical value of 15  $\mu\text{Vrms}$  by using 10 nF to less than 10  $\mu\text{Vrms}$  by using a

100 nF from the BYP pin to ground. For more information please refer to Figures 22 through 24.

**Minimum Load Current**

NCV8570B does not require any minimum load current for stability. The minimum load current is assured by the internal circuitry.

**Power Dissipation**

For given ambient temperature  $T_A$  and thermal resistance  $R_{\theta JA}$  the maximum device power dissipation can be calculated by:

$$P_{D(MAX)} = \frac{T_{J(MAX)} - T_A}{\theta_{JA}} \quad (\text{eq. 2})$$

The actual power dissipation can be calculated by the formula:

$$P_D = (V_{IN} - V_{OUT})I_{OUT} + V_{IN}I_{GND} \quad (\text{eq. 3})$$

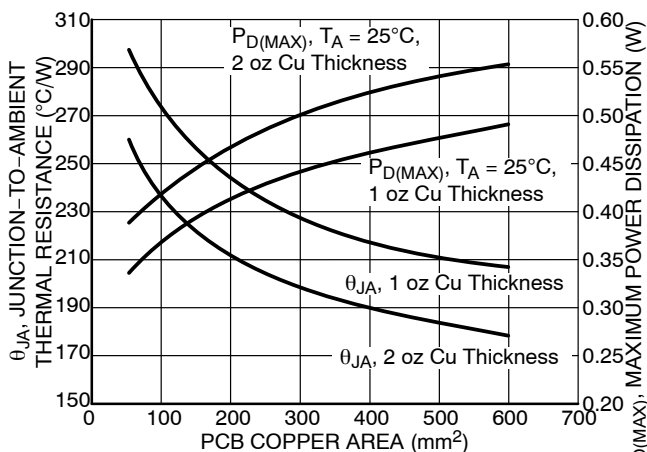

**Figure 57. Thermal Resistance and Maximum Power Dissipation vs. Copper Area (TSOP-5)**

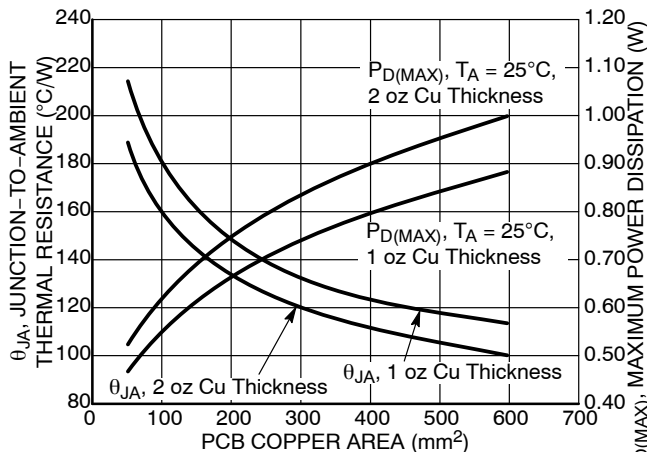

**Figure 58. Thermal Resistance and Maximum Power Dissipation vs. Copper Area (DFN6)**

**Load Regulation**

The NCV8570B features very good load regulation of 5 mV Max. in 0 mA to 200 mA range. In order to achieve this very good load regulation a special attention to PCB design is necessary. The trace resistance from the OUT pin to the point of load can easily approach 100 m $\Omega$  which will cause 20 mV voltage drop at full load current, deteriorating the excellent load regulation.

**Line Regulation**

The NCV8570B features very good line regulation of 0.6mV/V (typ). Furthermore the detailed Output Voltage vs. Input Voltage characteristics (Figures 47 through 49) show that up to  $V_{IN} = 5\text{ V}$  the Output Voltage deviation is typically less than 250  $\mu\text{V}$  for 1.8 V output voltage option and less than 150  $\mu\text{V}$  for higher output voltage options. Above the  $V_{IN} = 5\text{ V}$  the output voltage falls rapidly which leads to the typical 0.6 mV/V.

**Power Supply Rejection Ratio**

The NCV8570B features excellent Power Supply Rejection ratio. The PSRR can be tuned by selecting proper  $C_{noise}$  and  $C_{OUT}$  capacitors.

In the frequency range from 10 Hz up to about 10 kHz the larger noise bypass capacitor  $C_{noise}$  will help to improve the PSRR. At the frequencies above 10 kHz the addition of higher  $C_{OUT}$  output capacitor will result in improved PSRR.

**PCB Layout Recommendations**

Connect the input ( $C_{IN}$ ), output ( $C_{OUT}$ ) and noise bypass capacitors ( $C_{noise}$ ) as close as possible to the device pins.

The  $C_{noise}$  capacitor is connected to high impedance BYP pin and thus the length of the trace between the capacitor and the pin should be as small as possible to avoid noise pickup. In order to minimize the solution size use 0402 or 0603 capacitors. To obtain small transient variations and good regulation characteristics place  $C_{IN}$  and  $C_{OUT}$  capacitors close to the device pins and make the PCB traces wide. Larger copper area connected to the pins will also improve the device thermal resistance.

# NCV8570B

## ORDERING INFORMATION

Device*	Nominal Output Voltage	Marking	Package	Shipping†
NCV8570BMN180R2G	1.8 V	AK	DFN6 2 x 2.2 (Pb-Free)	3000 / Tape & Reel
NCV8570BMN250R2G	2.5 V	AP		
NCV8570BMN280R2G	2.8 V	AL		
NCV8570BMN300R2G	3.0 V	AM		
NCV8570BMN330R2G	3.3 V	AN		
NCV8570BSN18T1G	1.8 V	ADK	TSOP-5 (Pb-Free)	3000 / Tape & Reel
NCV8570BSN25T1G	2.5 V	ADZ		
NCV8570BSN28T1G	2.8 V	ADM		
NCV8570BSN30T1G	3.0 V	ADN		
NCV8570BSN33T1G	3.3 V	ADP		

†For information on tape and reel specifications, including part orientation and tape sizes, please refer to our Tape and Reel Packaging Specifications Brochure, BRD8011/D.

\*NCV Prefix for Automotive and Other Applications Requiring Unique Site and Control Change Requirements; AEC-Q100 Qualified and PPAP Capable

# NCV8570B

## PACKAGE DIMENSIONS

DFN6 2x2.2, 0.65P  
CASE 506BA  
ISSUE A

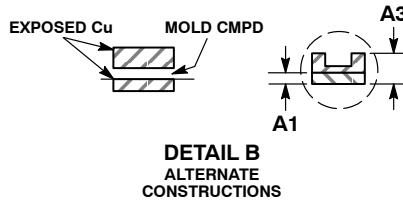
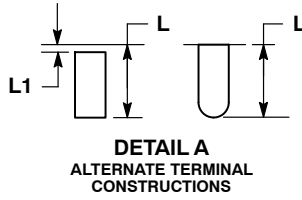
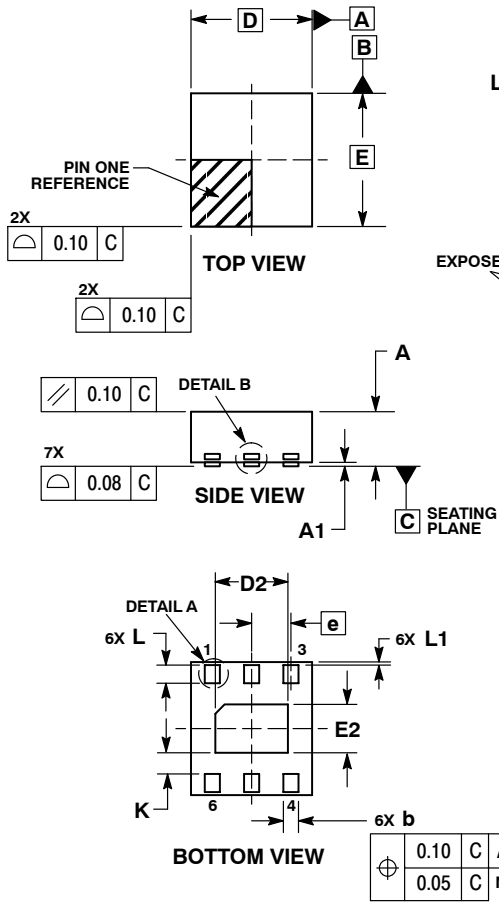

**NOTES:**

1. DIMENSIONING AND TOLERANCING PER ASME Y14.5M, 1994.
2. CONTROLLING DIMENSION: MILLIMETERS.
3. DIMENSION b APPLIES TO PLATED TERMINAL AND IS MEASURED BETWEEN 0.15 AND 0.20 mm FROM TERMINAL.
4. COPLANARITY APPLIES TO THE EXPOSED PAD AS WELL AS THE TERMINALS.

MILLIMETERS		
DIM	MIN	MAX
A	0.80	1.00
A1	0.00	0.05
b	0.20	0.30
D	2.00 BSC	
D2	1.10	1.30
E	2.20 BSC	
E2	0.70	0.90
e	0.65 BSC	
K	0.20	---
L	0.25	0.35
L1	0.00	0.10

**SOLDERING FOOTPRINT\***

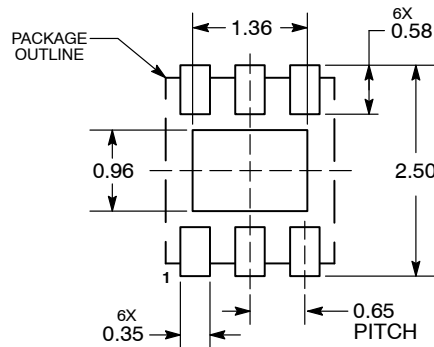

DIMENSIONS: MILLIMETERS

\*For additional information on our Pb-Free strategy and soldering details, please download the ON Semiconductor Soldering and Mounting Techniques Reference Manual, SOLDERRM/D.

# NCV8570B

## PACKAGE DIMENSIONS

### TSOP-5 CASE 483-02 ISSUE K

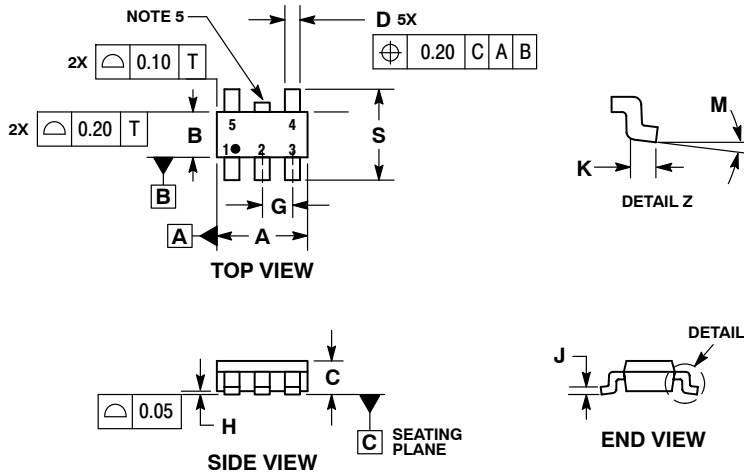

#### NOTES:

1. DIMENSIONING AND TOLERANCING PER ASME Y14.5M, 1994.
2. CONTROLLING DIMENSION: MILLIMETERS.
3. MAXIMUM LEAD THICKNESS INCLUDES LEAD FINISH THICKNESS. MINIMUM LEAD THICKNESS IS THE MINIMUM THICKNESS OF BASE MATERIAL.
4. DIMENSIONS A AND B DO NOT INCLUDE MOLD FLASH, PROTRUSIONS, OR GATE BURRS. MOLD FLASH, PROTRUSIONS, OR GATE BURRS SHALL NOT EXCEED 0.15 PER SIDE. DIMENSION A.
5. OPTIONAL CONSTRUCTION: AN ADDITIONAL TRIMMED LEAD IS ALLOWED IN THIS LOCATION. TRIMMED LEAD NOT TO EXTEND MORE THAN 0.2 FROM BODY.

DIM	MILLIMETERS	
	MIN	MAX
A	3.00	BSC
B	1.50	BSC
C	0.90	1.10
D	0.25	0.50
G	0.95	BSC
H	0.01	0.10
J	0.10	0.26
K	0.20	0.60
M	0°	10°
S	2.50	3.00

### SOLDERING FOOTPRINT\*

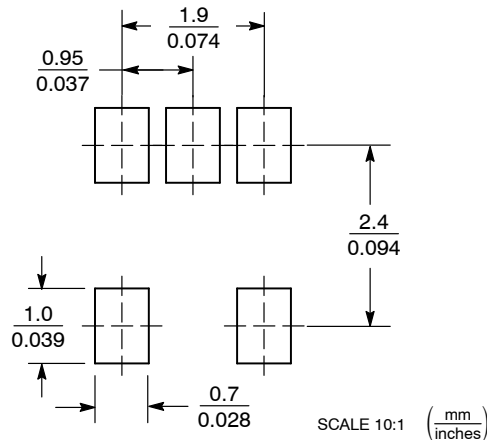

\*For additional information on our Pb-Free strategy and soldering details, please download the ON Semiconductor Soldering and Mounting Techniques Reference Manual, SOLDERRM/D.

ON Semiconductor and are registered trademarks of Semiconductor Components Industries, LLC (SCILLC). SCILLC owns the rights to a number of patents, trademarks, copyrights, trade secrets, and other intellectual property. A listing of SCILLC's product/patent coverage may be accessed at [www.onsemi.com/site/pdf/Patent-Marking.pdf](http://www.onsemi.com/site/pdf/Patent-Marking.pdf). SCILLC reserves the right to make changes without further notice to any products herein. SCILLC makes no warranty, representation or guarantee regarding the suitability of its products for any particular purpose, nor does SCILLC assume any liability arising out of the application or use of any product or circuit, and specifically disclaims any and all liability, including without limitation special, consequential or incidental damages. "Typical" parameters which may be provided in SCILLC data sheets and/or specifications can and do vary in different applications and actual performance may vary over time. All operating parameters, including "Typicals" must be validated for each customer application by customer's technical experts. SCILLC does not convey any license under its patent rights nor the rights of others. SCILLC products are not designed, intended, or authorized for use as components in systems intended for surgical implant into the body, or other applications intended to support or sustain life, or for any other application in which the failure of the SCILLC product could create a situation where personal injury or death may occur. Should Buyer purchase or use SCILLC products for any such unintended or unauthorized application, Buyer shall indemnify and hold SCILLC and its officers, employees, subsidiaries, affiliates, and distributors harmless against all claims, costs, damages, and expenses, and reasonable attorney fees arising out of, directly or indirectly, any claim of personal injury or death associated with such unintended or unauthorized use, even if such claim alleges that SCILLC was negligent regarding the design or manufacture of the part. SCILLC is an Equal Opportunity/Affirmative Action Employer. This literature is subject to all applicable copyright laws and is not for resale in any manner.

### PUBLICATION ORDERING INFORMATION

#### LITERATURE FULFILLMENT:

Literature Distribution Center for ON Semiconductor  
P.O. Box 5163, Denver, Colorado 80217 USA  
Phone: 303-675-2175 or 800-344-3860 Toll Free USA/Canada  
Fax: 303-675-2176 or 800-344-3867 Toll Free USA/Canada  
Email: [orderlit@onsemi.com](mailto:orderlit@onsemi.com)

N. American Technical Support: 800-282-9855 Toll Free  
USA/Canada  
Europe, Middle East and Africa Technical Support:  
Phone: 421 33 790 2910  
Japan Customer Focus Center  
Phone: 81-3-5817-1050

ON Semiconductor Website: [www.onsemi.com](http://www.onsemi.com)

Order Literature: <http://www.onsemi.com/orderlit>

For additional information, please contact your local Sales Representative

## Looking for pricing, stock, or lifecycle information?

Click below to explore more details on WIN SOURCE:

- ⊖ [View NCV8570BMN180R2G on WIN SOURCE](#)
- ⊖ [ON Semiconductor Information](#)

## Optimize Your Supply Chain with WIN SOURCE Solutions

- ✓ Global Sourcing Solution
- ✓ Obsolete Management
- ✓ Cost Control Management
- ✓ Shortage Management
- ✓ Alternative Solution
- ✓ Excess Inventory Management