

DATA SHEET

NE1618

Temperature monitor for
microprocessor systems

Product data
Supersedes data of 2001 Oct 03
File under Integrated Circuits, IC11 Handbook

2002 Jan 04

Temperature monitor for microprocessor systems

NE1618

FEATURES

- Monitors local and remote temperature
- Accuracy
 - ± 2 °C local (on-chip) sensor
 - ± 1.5 °C remote sensor with 1 °C resolution
 - ± 1.0 °C remote sensor with 0.125 °C resolution
- No calibration required
- Programmable over/under temperature alarm
- SMBus 2-wire serial interface
- 3 V to 3.6 V supply range
- 80 μ A supply current in operating mode
- 3 μ A (typical) supply current in standby mode
- Small 16-lead QSOP package

APPLICATIONS

- Desktop computers
- Notebook computers
- Smart battery packs
- Industrial controllers
- Telecom equipment

DESCRIPTION

The NE1618 is an accurate two-channel temperature monitor. It measures the temperature of itself and the temperature of a remote sensor. It can replace the NE1617 for a more precise measurement to the remote temperature when it operates in extended mode. The remote sensor is a diode connected transistor being in the form of either a discrete NPN/PNP, such as the 2N3904/2N3906, or a diode connected PNP built into another die, such as is done on some INTEL microprocessors.

The temperature of both the remote and local sensors are stored in the registers that can be read via a 2-wire SMBus. The data in the temp reading registers are updated at the end of every data conversion when the conversion is enable. At all time, data conversion is initiated automatically in the rate defined by the programmable data in the conversion rate register. However, a conversion can be forced to occur immediately by a one-shot programming.

The local temp is always measured with a resolution of 1.0 °C but the remote temp can be measured in either one of two modes: extended mode with a resolution of 0.125 °C and basic mode with a resolution of 1.0 °C. The mode is set up automatically according to the programmable data stored in the conversion rate register. (See Table 6). Extended mode is set when the conversion rate is slow (rate 0.7 Hz or less) and normal mode is set when the rate is high (conversion rate of 2, 4, or 8 Hz).

There is also an alarm that senses either an over or under temperature condition. The trip points for this alarm are also

programmable. The device can have 1 of 9 addresses (determined by 2 address pins), so there can be up to 9 of the NE1618 on the SMBus. It can also be put in a standby mode (in order to save power). This can be done either with software (over the SMBus) or with hardware (using the $\overline{\text{STBY}}$ pin).

PIN CONFIGURATION

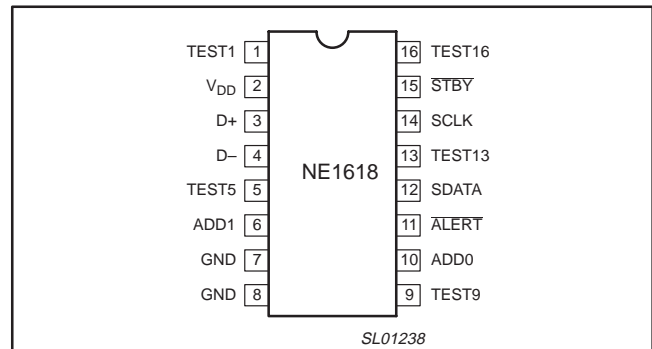

Figure 1. Pin configuration

PIN DESCRIPTION

PIN #	FUNCTION	DESCRIPTION/COMMENTS
1	TEST1	Factory use only ¹
2	V _{DD}	Positive supply ²
3	D+	Positive side of remote sensor
4	D-	Negative side of remote sensor
5	TEST5	Factory use only ¹
6	ADD1	Device address pin (3-State)
7	GND	Ground
8	GND	Ground
9	TEST9	Factory use only ¹
10	ADD0	Device address pin (3-State)
11	$\overline{\text{ALERT}}$	Open drain output used as interrupt or SMBus alert
12	SDATA	SMBus serial data input/output open drain
13	TEST13	Factory use only ¹
14	SCLK	SMBus clock input
15	STBY	Hardware standby input pin HIGH = normal operating mode LOW = standby mode
16	TEST16	Factory use only ¹

NOTES:

1. These pins should either floating or be tied to ground.
2. V_{DD} pin should be decoupled by a 0.1 μ F capacitor.

ORDERING INFORMATION

PART NUMBER	PACKAGE	DRAWING NUMBER
NE1618DS	16-lead QSOP package ¹	SOT519-1

NOTE:

1. Also called "SSOP16".

Temperature monitor for microprocessor systems

NE1618

FUNCTIONAL BLOCK DIAGRAM

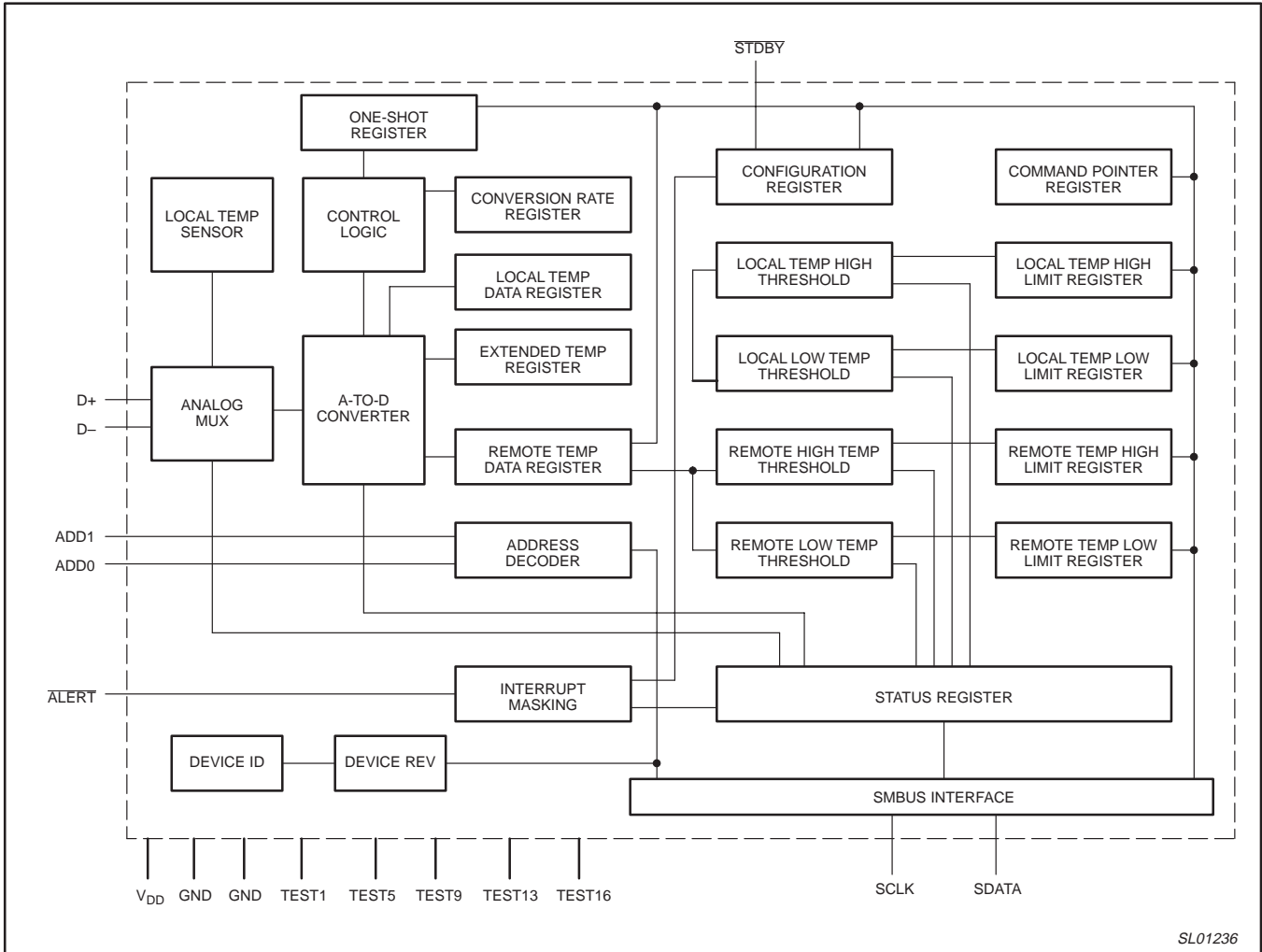

Figure 2. Functional block diagram.

SL01236

Temperature monitor for microprocessor systems

NE1618

TYPICAL OPERATING CIRCUIT

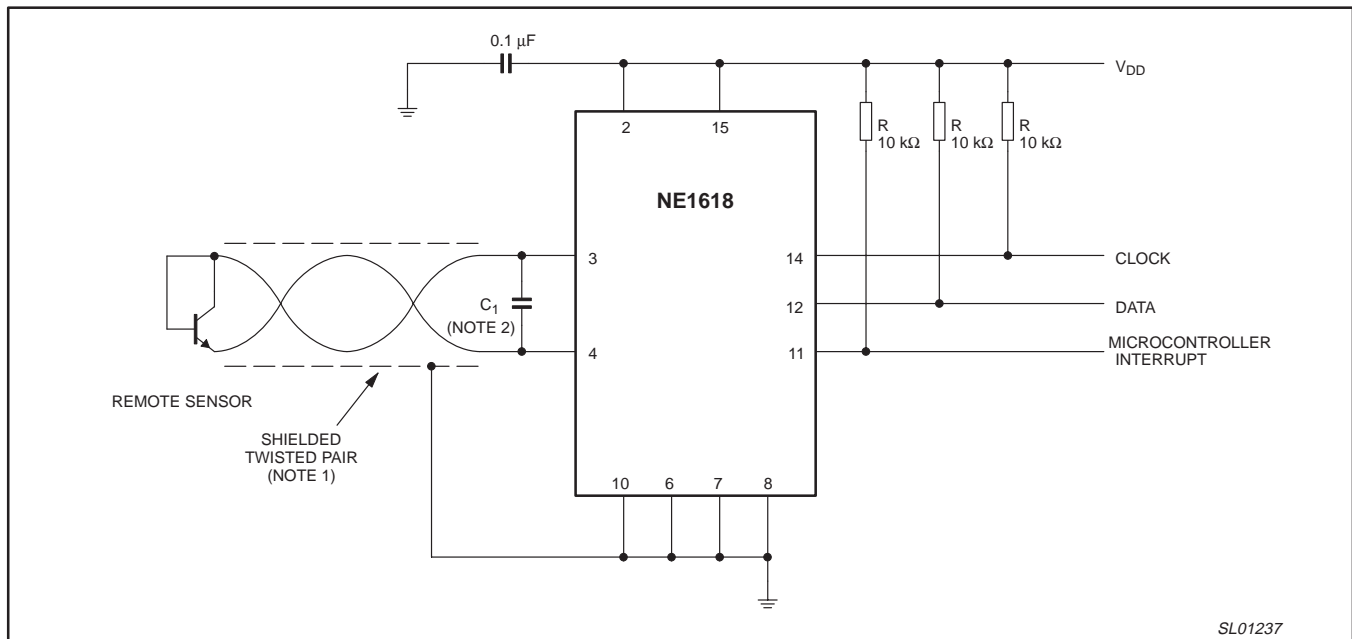

NOTES:

1. May be required if remote diode is in a noisy environment and/or several feet from the NE1618.
2. May be required in noisy environment. Up to 2200 pF may be used.

Figure 3. Typical operating circuit.

ABSOLUTE MAXIMUM RATINGS

PARAMETER	MIN.	MAX.	UNIT
V _{DD} to GND	-0.3	+6	V
D+, ADD0, ADD1	-0.3	V _{DD} +0.3	V
D- to GND	-0.3	+0.8	V
SCLK, SDATA, ALERT, STBY	-0.3	+6	V
Input current SDATA	-1	+50	mA
D- current		±1	mA
ESD			
Human Body Model	-	2000	V
Machine Model	-	200	V
Operating temperature range	0	+120	°C
Maximum junction temperature		+150	°C
Storage temperature range	-65	+150	°C

NOTE:

1. This is a stress rating only. Functional operation of the device as indicated in the operational section is not applied to this absolute maximum rating. Stress above those listed in "Absolute maximum ratings" may cause permanent damage to the device, and exposure to any of these rating conditions for extended periods may affect device reliability.

Temperature monitor for microprocessor systems

NE1618

ELECTRICAL CHARACTERISTICS $V_{DD} = 3.3\text{ V}$; $T_{amb} = 5\text{ °C}$ to $+120\text{ °C}$; unless otherwise noted.

PARAMETER	CONDITIONS		LIMITS			UNIT
			MIN.	TYP.	MAX.	
Temperature resolution			1			°C
Local temperature error	$T_{amb} = +60\text{ °C}$ to $+100\text{ °C}$	$V_{DD} = 3.3\text{ V}$		± 0.75	± 1.5	°C
		$V_{DD} = 5.0\text{ V}$ ¹		± 1.25	± 2.0	°C
	$T_{amb} = 0\text{ °C}$ to $+120\text{ °C}$	$V_{DD} = 3.3\text{ V}$		± 2.0	± 3.0	°C
		$V_{DD} = 5.0\text{ V}$ ¹		± 2.5	± 3.5	°C
Remote temperature error (1 °C resolution)	$T_{remote} = +60\text{ °C}$ to $+100\text{ °C}$	$V_{DD} = 3.3\text{ V}$			± 3.0	°C
		$V_{DD} = 5.0\text{ V}$ ¹			± 3.5	°C
	$T_{remote} = 0\text{ °C}$ to $+120\text{ °C}$	$V_{DD} = 3.3\text{ V}$			± 5.0	°C
		$V_{DD} = 5.0\text{ V}$ ¹			± 5.5	°C
Extended Remote temp error (0.125 °C resolution)	$T_{remote} = +70\text{ °C}$ to $+100\text{ °C}$	$V_{DD} = 3.3\text{ V}$			± 1.0	°C
		$V_{DD} = 5.0\text{ V}$ ¹			± 1.5	°C
	$T_{remote} = 0\text{ °C}$ to $+120\text{ °C}$	$V_{DD} = 3.3\text{ V}$			± 3.0	°C
		$V_{DD} = 5.0\text{ V}$ ¹			± 3.5	°C
Extended relative temp error ² (0.125 °C resolution)	$T_{remote} = +70\text{ °C}$ to $+100\text{ °C}$	$V_{DD} = 3.3\text{ V}$			± 0.25	°C
		$V_{DD} = 5.0\text{ V}$ ¹			± 0.75	°C
	$T_{remote} = 0\text{ °C}$ to $+120\text{ °C}$	$V_{DD} = 3.3\text{ V}$			± 0.50	°C
		$V_{DD} = 5.0\text{ V}$ ¹			± 1.0	°C
Under voltage lockout ³	V_{DD} input disables A/D conversion ⁴			2.1	2.95	V
Power-on reset threshold	V_{DD} input falling edge ⁵		1.0		2.5	V
Power supply current (average)	Conversion data = 02h			80	160	μA
	Conversion data = 05h			100	270	μA
Power supply current (standby)	SMBus inactive			3	10	μA
Conversion time (busy duration)	Basic measurement				150	ms
	Extended measurement				750	ms
Conversion rate error	Percentage error in programmed rate $> 1\text{ Hz}$ ⁶		-30		+30	%
Remote sensor source current	HIGH level			100		μA
	LOW level			10		μA
Address pin bias current	Momentary as the address is being read ^{7,8}			50		μA

NOTES:

- The NE1618 is optimized for 3.3 V_{DD} operation. The listed accuracy limits for 5 V_{DD} operation are guaranteed by design and 100% QA sample tested in production.
- Guaranteed by design.
- Definition of Under Voltage Lockout (UVL): The value of V_{DD} below which the internal A/D converter is disabled. This is designed to be a minimum of 200 mV above the power-on reset. During the time that it is disabled, the temperature that is in the "read temperature registers" will remain at the value that it was before the A/D was disabled. This is done to eliminate the possibility of reading unexpected false temperatures due to the A/D converter not working correctly due to low voltage. In case of power-up (rising V_{DD}), the reading that is stored in the "read temperature registers" will be the default value of 0 °C. V_{DD} will rise to the value of UVL, at which point the A/D will function correctly and normal temperatures will be read.
- V_{DD} (rising edge) voltage below which the ADC is disabled.
- V_{DD} (falling edge) voltage below which the logic is reset.
- For conversion rate $\leq 1\text{ Hz}$, extended measurement requires about 400 ms more for conversion.
- Address is read at power-up and at start of conversion for all conversions except the fastest rate.
- Due to the bias current, any pull-up/down resistors should be $\leq 2\text{ k}\Omega$.

Temperature monitor for microprocessor systems

NE1618

SMBus INTERFACE AC SPECIFICATIONS

$V_{DD} = 3.0\text{ V to }3.6\text{ V}$; $T_{amb} = 0\text{ }^{\circ}\text{C to }+125\text{ }^{\circ}\text{C}$ unless otherwise noted.

These specifications are guaranteed by design and not tested in production.

SYMBOL	PARAMETER	CONDITIONS	MIN	TYP	MAX	UNIT
V_{IH}	Logic input high voltage for STBY, SCLK, SDATA	$V_{DD} = 3\text{ V to }5.5\text{ V}$	2.2			V
V_{IL}	Logic input low voltage for STBY, SCLK, SDATA	$V_{DD} = 3\text{ V to }5.5\text{ V}$			0.8	V
I_{OL}	Logic output low sink current for ALERT SDATA	$V_{OL} = 0.4\text{ V}$ $V_{OL} = 0.6\text{ V}$	1.0 6.0			mA mA
I_{IH} & I_{IL}	Logic input current	$V_{IN} = V_{DD}$ or GND	-1.0		1.0	μA
C_{IN}	SMBus input capacitance for SCLK, SDATA			5		pF
f_{SCLK}	SCLK operating frequency	See Figure 4	0		100	kHz
t_{LOW}	SCLK low time	See Figure 4	4.7	5.0		μs
t_{HIGH}	SCLK high time	See Figure 4	4.0	5.0		μs
t_{BUF}	SMBus free time. Delay from SDA stop to SDA start	See Figure 4	4.7			μs
$t_{HD:STA}$	Hold time of start condition. Delay from SDA start to first SCL H-L	See Figure 4	4.0			μs
$t_{HD:DAT}$	Hold time of data. Delay from SCL H-L to SDA edges	See Figure 4	0			ns
$t_{SU:DAT}$	set-up time of data. Delay from SDA edges to SCL L-H	See Figure 4	250			ns
$t_{SU:STA}$	set-up time of repeat start condition. Delay from SCL L-H to restart SDA	See Figure 4	250			ns
$t_{SU:STO}$	set-up time of stop condition. Delay from SCL L-H to SDA stop.	See Figure 4	4.0			μs
t_F	Fall time of SCL and SDA	See Figure 4			1.0	μs

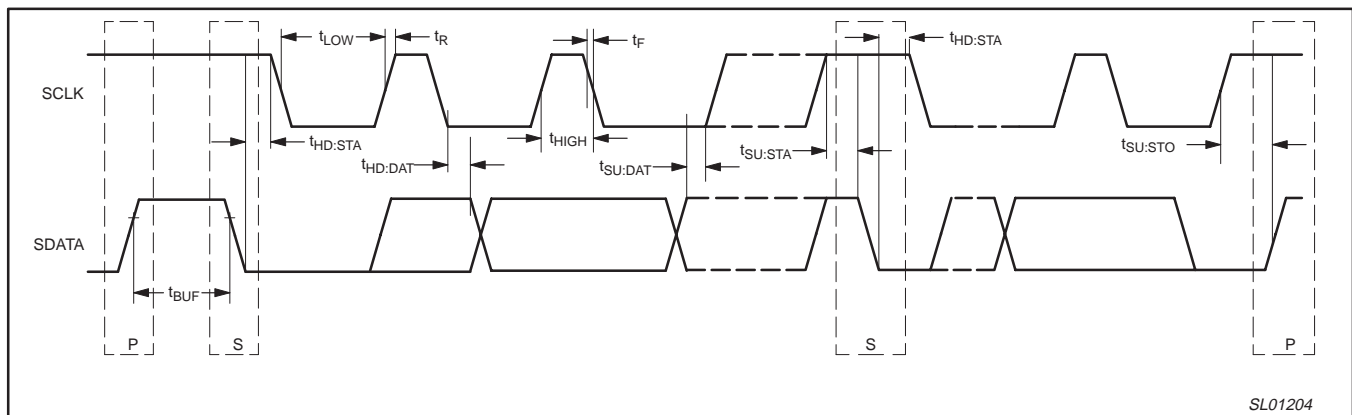

Figure 4. Timing measurements.

NOTE:

The NE1618 does not include the SMBus timeout capability ($t_{LOW:SEXT}$ and $t_{LOW:MEXT}$).

Temperature monitor for microprocessor systems

NE1618

FUNCTIONAL DESCRIPTION

Serial bus interface

The NE1618 can be connected to a compatible 2-wire serial interface System Management Bus (SMBus) as a slave device under the control of a master device, using two device terminals SCLK and SDATA. The controller will provide a clock signal to the device SCLK pin and write/read data to/from the device through the device SDATA pin. External pull-up resistors, about 10 k Ω each, are needed for these two terminals due to the open drain circuitry.

Data of 8-bit digital byte or word are used for communication between the controller and the device using SMBus protocols which will be described more in the SMBus interface section. The operation of the device to the bus is described with details in the following sections.

Slave address

The 7-bit address data of the NE1618 on the bus is defined by three-level logical connections applied to the device address pins ADD0 and ADD1. They are either opened or connected directly to the GND or V_{DD} with the use of a resistor which value should be equal to or less than 2 k Ω . The selectable addresses are listed in Table 1. Any one of those nine combinations can be used for any device and more than one devices can reside on the same bus without conflict. Notice that because the state of the device address pins is sampled and latched not only at the power-up step but also at starting point of every conversion, the address connections must be permanently existent.

Table 1. Device slave address

ADD0 pin	ADD1 pin	7-BIT ADDRESS DATA
GND	GND	0011 000
GND	NC	0011 001
GND	V _{DD}	0011 010
NC	GND	0101 001
NC	NC	0101 010
NC	V _{DD}	0101 011
V _{DD}	GND	1001 100
V _{DD}	NC	1001 101
V _{DD}	V _{DD}	1001 110

1. NC = Not Connected.

Registers

The NE1618 contains a number of registers which names, commands, power-on reset (POR) status and functions are listed in Table 2. It includes:

- Configuration register to provide control and configuration the NE1618
- Status register to provide the flags resulting from temp limit comparisons
- Measuring and limits temp registers
- ID and test registers

The registers are used to store either programmable data for setting device operation or resultant data from device measurement. Data are stored in registers by 8-bit digital byte, either in 2's complement format for temperature-related data or in straight format for others. The register command byte is used to addressing the register in SMBus communication. Writing and reading registers will be performed on the SMBus by a controller. The registers are divided into two groups: only-read registers named with a prefix of R– and only-write registers named with a prefix of W– (including the one-shot register OSHT). You should write programmable data to the only-write registers and read data from the only-read registers. Attempting to write to any R– register or read from any W– register will produce an invalid result: the writing data would be ignored, the reading data would be equal to FFh. Some of registers are in pair representing a same item for different bus operations: read and write, for example, RC and WC are related to the device configuration, one for reading and the other for writing.

The reserved registers are used only at the manufacturer for test purposes.

Temperature monitor for microprocessor systems

NE1618

Table 2. Register assignments

REGISTER NAME	COMMAND BYTE	POR STATE	FUNCTION
RDID	FEH	N/A	Read device ID
RDRV	FFH	N/A	Read device revision
RIT	00H	0000 0000	Read internal or local temp
RET	01H	0000 0000	Read external or remote temp
REET	10H	0000 0000	Read extended external temp
RS	02H	N/A	Read status
RC	03H	0000 0000	Read configuration
RCR	04H	0000 0010	Read conversion rate
RIHL	05H	0111 1111	Read internal temp HIGH limit
RILL	06H	1100 1001	Read internal tem low limit
REHL	07H	0111 1111	Read external temp HIGH limit
RELL	08H	1100 1001	Read external temp LOW limit
WC	09H	N/A	Write configuration
WCR	0AH	N/A	Write conversion rate
WIHL	0BH	N/A	Write internal temp HIGH limit
WILL	0Ch	N/A	Write internal temp LOW limit
WEHL	0Dh	N/A	Write external temp HIGH limit
WELL	0Eh	N/A	Write external temp LOW limit
OSHT	0Fh	N/A	One shot command
RESERVED	11H	N/A	Reserved
RESERVED	12H	N/A	Reserved
RESERVED	13H	N/A	Reserved
RESERVED	14H	N/A	Reserved
RESERVED	15H	N/A	Reserved

Power-on reset (POR)

When the power is applied to the NE1618 while the device $\overline{\text{STDBY}}$ input pin is at low state, the device will enter into its power-on reset state and its registers are reset to their default values as shown in the Table 2 resulting in:

- Interrupt latch is cleared, the ALERT output driver is off and the $\overline{\text{ALERT}}$ pin is pulled to HIGH by an external pull-up resistor.
- The conversion rate is set to the default value of about 0.2 Hz
- Temp limits for both channels are +127 °C for high limit and -55 °C for low limit.
- Register pointer is set to 00 for ready to reading the RIT data.

Notice that the content of the register that has indeterminate default value will be unknown.

During the POR state of the device, the on-board A-to-D converter is disabled and the measurement function of the device is inactive. However, the SMBus interface is alive to bus communication meaning that reading and writing the registers can be performed. If there is no SMBus activity then the device will draw a small power supply current less than 10 μA . Writing temp limits into the limits registers if needed should usually be performed at this stage.

Starting conversion

Upon POR, if the $\overline{\text{STDBY}}$ input pin is set to HIGH while the RUN/STOP bit 6 of the configuration register is equal to zero as default, then the device will enter into its free-running operation mode in which the device A-to-D converter is enabled and the

measurement function is activated. In this mode, the device cycles the measurements of local temp and remote temp automatically and periodically. The conversion period is defined by the programmable conversion rate stored in the conversion register. It also performs comparisons between readings and limits of the temperature in order to set the flags and interruption accordingly at the end of every conversion. Measured values are stored in the temp registers, results of limit comparisons are reflected by the status of the flag bits in the status register and interruption is reflected by the logical level of the $\overline{\text{ALERT}}$ output pin. Temp and status data can be read at any time. Temp limit values should be written into the limit registers before starting conversion to avoid false conditions of the status.

Low power standby modes

The device can be put into one of the two standby modes from the free-running state at any time: hardware standby mode by setting the $\overline{\text{STDBY}}$ input pin to LOW, or software standby mode by setting the RUN/STOP bit 6 of the configuration register to 1. In either standby mode, the free-running operation is stopped, the supply current is reduced to less than 10 μA if there is no SMBus activity, all data in the device registers are retained. However, the SMBus is still active and reading or writing registers can still be performed. The main difference between the two standby modes is related to the activation of the A-to-D conversion: data conversion can be activated in the software standby mode but not in the hardware standby mode. In software standby mode, an one-shot command will initiate a single conversion which has the same effect in comparing with any conversion that occurs when the device is in its

Temperature monitor for microprocessor systems

NE1618

free-running mode. In hardware standby mode, the A-to-D converter is disabled and conversion operation is inhibited.

Notice that if a hardware standby command is received when the device is in free-running mode with a conversion is in progress, the conversion cycle will stop and the register data will not be updated.

Temperature measurement

The NE1618 contains an on-chip temp sensor for measuring the local or internal temperature and provides input pins D+ and D- for connecting to a remote temp sensor in order to measure the remote or external temperature. The remote sensor should be a diode-type sensor and must be connected to the D+ and D- pins properly: anode to the D+ and cathode to the D-.

The method of temp measurement is based on the difference of the diode VBE at two operating current levels given by:

$$\Delta VBE = (KT/q) \cdot \ln(N)$$

where:

- K: Boltzman's constant
- T: absolute temperature in °K
- q: electron charge
- LN: natural logarithm
- N: ratio of the two operating currents

Because, in measuring the remote diode VBE, the NE1618 provides two current sources of about 10 µA and 100 µA and the sensed voltage between two pins D+ and D- is limited within 0.25 V and 0.95 V, the external diode should be selected to meet these current and voltage requirements. The diode-connected PNP transistor provided on the Pentium series microprocessor is typically used, or the discrete diode-connected low-power transistor 2N3904 is recommended.

When the temperature is measured, local and remote, the ΔVBE is converted into digital data by the on-chip sigma-delta A-to-D converter. The results are stored in the three temp registers (RIT, RET and REET) and also compared with the limits stored in the temp limits registers in order to set accordingly the flag bits in the status register and to generate interruption if any fault condition occurs. The content of temp registers are updated upon completion of every conversion and they can be read at any time.

In the addition of providing the basic measurement with a resolution of 1 °C, the NE1618 includes the extended measurement for the remote temp with a resolution 0.125 °C. The extended measurement can be used in enhanced application for monitoring precisely the die temp of integrated circuits. Because the extended measurement is corporate with an on-board 11-bit A-to-D converter, the resulted data is an 11-bit digital number which is divided into two groups for storing into two registers RET and REET. The group of eight MSB bits of the data is stored in the RET register and the group of three LSB bits of the data is stored in the REET register in its MSB positions. Therefore, the data of those two registers must be correctly combined to get the extended remote temp data.

When the device is in basic measuring mode (by setting the conversion rate data higher than 04h) the A-to-D converter uses

only 8 bits for the conversion, the REET content is cleared. Only the 8-bit data stored in the RET with resolution of 1 °C is significant for the remote temperature.

Notice that the extended measurement only works if the device is in its free-running operation mode. It does not work when the device is in its standby mode and the conversion is activated by a one-shot command. A one-shot command will produce the same result as of basic measurement instead of the extended measurement even though the slow conversion rate has been selected.

Temperature data format

For local temp measurement, because the extended mode has no effect to the measurement, the resulted temp value can be integer number which is equivalent to the 2's complement value of the 8-bit byte data of the RIT register with 1 °C resolution as shown in Table 3.

For remote temp measurement, the resulted temp value can be a floating number which is made up by two parts: the integer portion is derived from the RET data using data format as shown in Table 3 and the decimal or extended portion is derived from the REET data using data format as shown in Table 4. Notice that when the device is in basic measurement mode (by setting the conversion data more than 04h) the extended portion is always equal to 0 and the resulted data is only the one which is derived from RET register with 1 °C resolution.

Table 3. Temperature data format (RIT & RET)

TEMPERATURE (°C)	8-BIT DIGITAL DATA
+127	0 111 1111
+126	0 111 1110
+100	0 110 0100
+50	0 011 0010
+25	0 001 1001
+1	0 000 0001
≤0	0 000 0000

Table 4. Extended data format (REET)

TEMPERATURE (°C)	8-BIT DIGITAL DATA
0.000	0000 0000
0.125	0010 0000
0.250	0100 0000
0.375	0110 0000
0.500	1000 0000
0.625	1010 0000
0.750	1100 0000
0.875	1110 0000

Temperature monitor for microprocessor systems

NE1618

Configuration register

The configuration register is used to mask the Alert interrupt and/or to put the device in software standby mode. Only two bits 6 and 7 of this register are used as listed in Table 5. Bit 7 is used to mask the device ALERT output from Alert interruption when this bit is set to 1, and bit 6 is used to activate the standby software mode when this bit is set to 1.

This register can be written or read using the commands of registers named WC and RC accordingly. Upon power-on reset (POR), both bits are reset to zero.

Table 5. Configuration register bit assignments

BIT	NAME	POR STATE	FUNCTION
7 (MSB)	MASK	0	Mask ALERT interrupt: Interrupt is enabled when this bit is LOW, and disabled when this bit is HIGH.
6	RUN/STOP	0	Standby or run mode control: When LOW, running mode is enabled. When HIGH, standby mode is initiated.
5 to 0	RESERVED	n/a	n/a

Conversion rate register

The conversion rate register is used to store programmable conversion data, which defines the time interval between conversions in standard free-running auto-convert mode. Table 6 shows all applicable data and rates for the device. Only three LSB bits of the register are used and other bits are reserved for future use. This register can be written to and read back over the SMBus using commands of the registers named WCR and RCR respectively. The POR default conversion data is 02h.

Because of the timing asynchronization, when changing the conversion rate from fast to slow, or vice versa, you may get an invalid data for the external temp reading, and an Alert interruption as well. Therefore, caution must be taken when doing a change of conversion rate. Changing conversion should be done in one of the following ways:

- Apply this sequential operation:
 - Put the device into its standby mode (by setting bit6 of the WC register).
 - Wait at least 750 ms (to ensure the current conversion if there is one to be completed).
 - Change the conversion rate (by writing the conversion data into the WCR register).
 - Put the device back into its normal mode (by clearing bit6 of the WC register).
- Writing the conversion data to the conversion register WCR when the busy bit is off. The busy bit can be monitored by reading the Status Register (SR) bit 7.

We suggest that method "1." is preferred because it will provide the correct temp data in a defined time. Releasing the device from shutdown mode by clearing bit6 of the WC register also initiates a new conversion, and all the register data will be updated at the end

of the conversion in 750 ms (max.) for slow rate, and 170 ms for fast rate.

The device will be automatically put into the extended measurement mode when the conversion rate data is less than or equal to 04h. Otherwise, it will be in basic measurement mode for the remote temp.

Notice that the average supply current, as well as the device power consumption, is increased with the conversion rate.

Table 6. Conversion rate control byte

DATA	CONVERSION RATE (Hz)	AVERAGE SUPPLY CURRENT (μ A Typ. @ $V_{DD} = 3.3$ V)
00h	0.06	TBD
01h	0.12	TBD
02h	0.22	TBD
03h	0.40	TBD
04h	0.70	TBD
05h	2	TBD
06h	4	TBD
07h	8	TBD
08h to FFh	Reserved	n/a

Temperature limit registers

The device has four registers to be used for storing programmable temperature limits, including the high limit and the low limit for each channel of the external and internal diodes. Data of the temperature register (RIT and RET) for each channel are compared with the contents of the temperature limit registers of the same channel, resulting in alarm conditions. If measured temperature either equals or exceeds the corresponding temperature limits, an Alert interrupt is asserted and the corresponding flag bit in the status register is set. The temperature limit registers can be written to and read back using commands of registers named WIHL, WILL, WEHL, WELL, RIHL, RILL, REHL, RELL accordingly. The POR default values are +127 °C (0111 1111) for the HIGH limit and -55 °C (1100 1001) for the LOW limit.

Notice that only the RET data is used in limit comparison and REET data is ignored.

One-shot command

The one shot command is not actually a data register as such and a write operation to it will initiate an ADC conversion. The send byte format of the SMBus, as described later, with the use of OSHT command (0Fh), is used for this writing operation. In normal free-running-conversion operation mode of the device, a one-shot command immediately forces a new conversion cycle to begin. However, if a conversion is in progress when a one-shot command is received, the command is ignored. In software standby mode, the one-shot command generates a single conversion and comparison cycle and then puts the device back in its standby mode after the conversion. In hardware standby mode, the one shot is inhibited.

Notice that a one-shot command will clear the REET register and set a basic measurement for that cycle.

Temperature monitor for microprocessor systems

NE1618

Status register

The content of the status register reflects condition status resulting from all of these activities: comparisons between temperature measurements and temperature limits, the status of ADC conversion, and the hardware condition of the connection of external diode to the device. Bit assignments and bit functions of this register are listed in Table 7. This register can only be read using the command of register named RS. Upon POR, the status of all flag bits are reset to zero. The status byte is cleared by any successful read of the status register unless the fault condition persists.

Notice that any one of the fault-conditions, except the conversion busy, also introduces an Alert interrupt to the SMBus that will be described in the following section. Also, whenever a one-shot command is executed, the status byte should be read after the conversion is completed, which is about 170 ms after the one-shot command is sent.

Table 7. Status register bit assignment

BIT	NAME	POR STATE	FUNCTION
7 (MSB)	BUSY	n/a	High when the ADC is busy converting
6	IHLF*	0	High when the internal temperature high limit has tripped
5	ILLF*	0	High when the internal temperature low limit has tripped
4	EHLF*	0	High when the external temperature high limit has tripped
3	ELLF*	0	High when the external temperature low limit has tripped
2	OPEN* SHORT	0	High when the external diode is opened or shorted
1 to 0	n/a	0	Reserved

* These flags stay high until the status register is read or POR is activated.

Alert interrupt

The ALERT output is used to signal Alert interruption from the device to the SMBus and is active low. Because this output is an open-drain output, a pull-up resistor (10 kΩ typ.) to V_{DD} is required, and slave devices can share a common interrupt line on the same SMBus. An Alert interrupt is asserted by the device whenever any one of the fault conditions, as described in the Status register section, occurs: measured temperature equals or exceeds corresponding temp limits, the remote diode is physically disconnected from the device pins. Alert interrupt signal is latched and can only be cleared by reading the Alert Response byte from the Alert Response Address which is a special slave address to the SMBus. The ALERT output can not be reset by reading the device status register. The device was designed to accommodate the Alert interrupt detection capability of the SMBus.

Basically, the SMBus provides Alert response interrupt pointers in order to identify the slave device which has caused the Alert interrupt. The 7-bit Alert slave address is 0001 100 and the Alert response byte reflects the slave address of the device which has

caused Alert interrupt. Bit assignments of the Alert response byte are listed in Table 8. The ALERT output will be reset to HIGH state upon reading the Alert response slave address unless the fault condition persists.

Table 8. Alert response bit assignment (Alert response address = 0001 100)

ALERT RESPONSE BIT	NAME ADDRESS BIT	FUNCTION
7 (MSB)	ADD7	Indicate address B6 of alerted device
6	ADD6	Indicate address B5 of alerted device
5	ADD5	Indicate address B4 of alerted device
4	ADD4	Indicate address B3 of alerted device
3	ADD3	Indicate address B2 of alerted device
2	ADD2	Indicate address B1 of alerted device
1	ADD1	Indicate address B0 of alerted device
0 (LSB)	1	Logic 1

Fault detection

The NE1618 has a fault detector to the diode connection. The connection is checked when a conversion is initiated and the proper flags are set if the fault condition has occurred.

D+ & D-	ALERT OUTPUT	RET DATA STORAGE	STATUS SET FLAG
Opened	Low	-128°C	B2 & B3
Shorted	Low	-128°C	B2 & B3

SMBus interface

The device can communicate over a standard 2-wire serial interface System Management Bus (SMBus) using the device pins SCLK and SDATA. The device employs four standard SMBus protocols: Write Byte, Read Byte, Send Byte and Receive Byte. Data formats of those protocols are shown in Table 9 with following notifications:

- The SMBus master initiates data transfer by establishing a start condition (S) and terminates data transfer by generating a stop condition (P).
- Data is sent over the serial bus in sequence of 9 clock pulses according to each 8-bit data byte followed by 1-bit status of the device acknowledgement (A).
- The 7-bit slave address is equivalent to the selected address of the device.
- The command byte is equivalent to the selected command of the device register
- The send byte format is often used for the one-shot conversion command.
- The receive byte format is used for quicker transfer data from a device reading register which was previously selected by a read byte format.

Temperature monitor for microprocessor systems

NE1618

Table 9. SMBus Interface Protocols

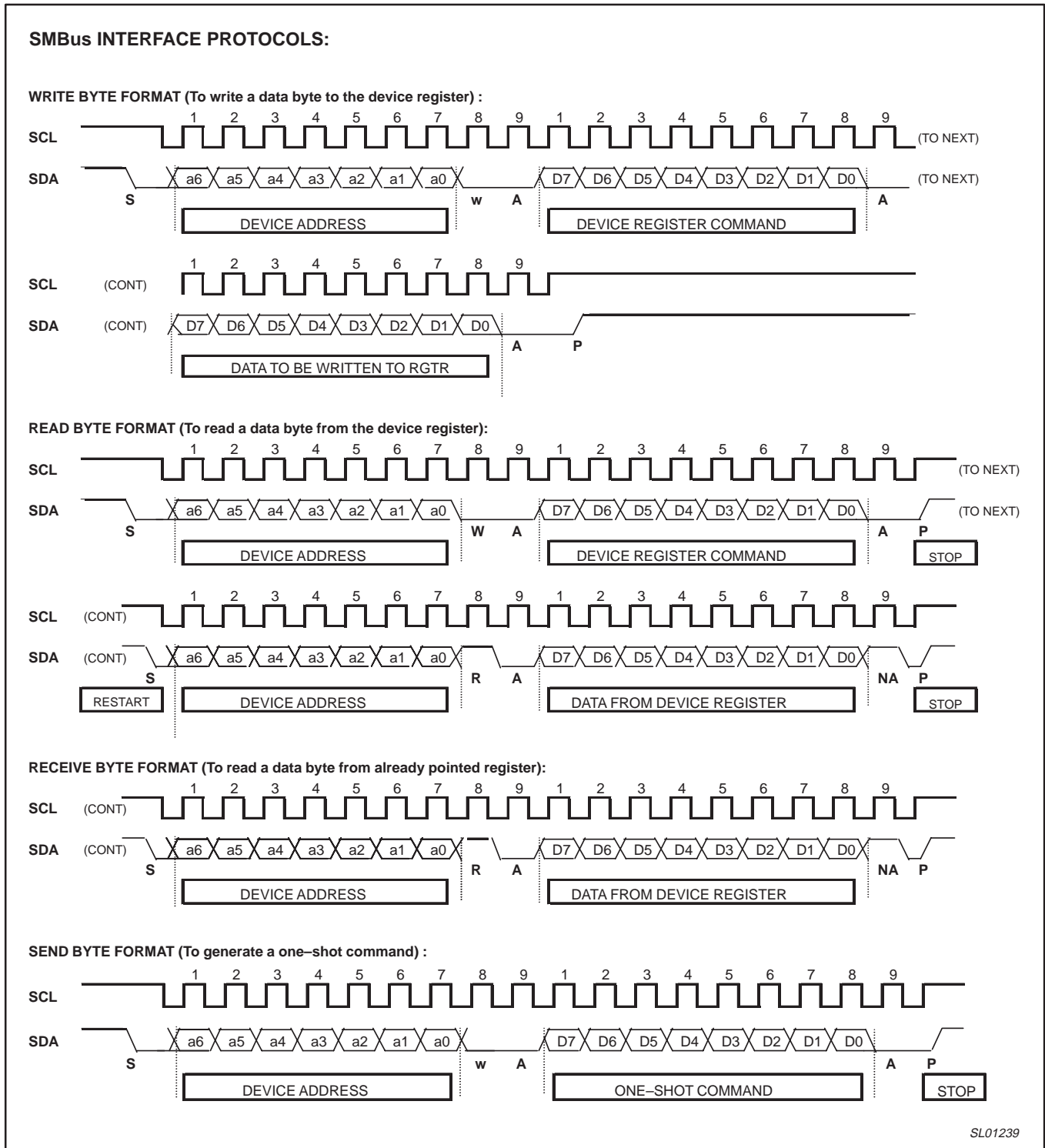

Temperature monitor for microprocessor systems

NE1618

PC BOARD LAYOUT CONSIDERATION

Because the NE1618 is used to measure a very small voltage from the remote sensor, care must be taken to minimize noise induced at the sensor inputs, especially in the computer motherboard noisy environment. These precautions should be considered:

- Place the NE1618 as close as possible to the remote sensor. It can be from 4 to 8 inches, as long as the worst noise sources such as clock generator, data and address buses, CRTs are avoided.
- Route the D+ and D– lines in parallel and close together with ground guards enclosed.
- Leakage currents due to PC board contamination must be considered. Error can be introduced by the leakage current as shown on the characteristics curve (Temperature Error vs. PC Board Resistance).
- Use wide tracks to reduce inductance and noise pickup that may be introduced by narrow ones. The width of 10 mil and space of 10 mil are recommended.

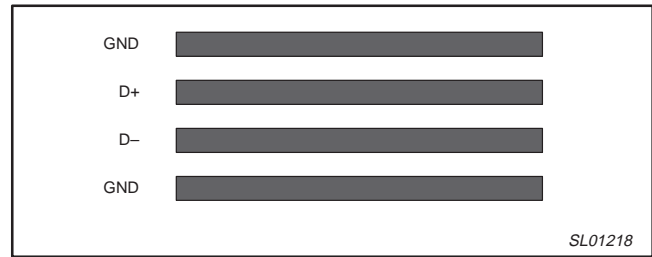

- Place a bypass capacitor of 0.1 μF close to the V_{DD} pin and an input filter capacitor of 2200 pF close to the D+ and D– pins.
- A shielded twisted pair is recommended for a long distance remote sensor. Connect the shield of the cable at the device side to the NE1618 GND pin and leave the shield at the remote end unconnected to avoid ground loop. Also notice that the series resistance of the cable may introduce measurement error; 1 Ω can introduce about 0.5 $^{\circ}\text{C}$.

Temperature monitor for microprocessor systems

NE1618

SSOP16: plastic shrink small outline package; 16 leads;
body width 3.9 mm; lead pitch 0.635 mm

SOT519-1

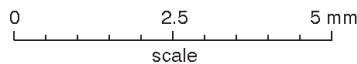
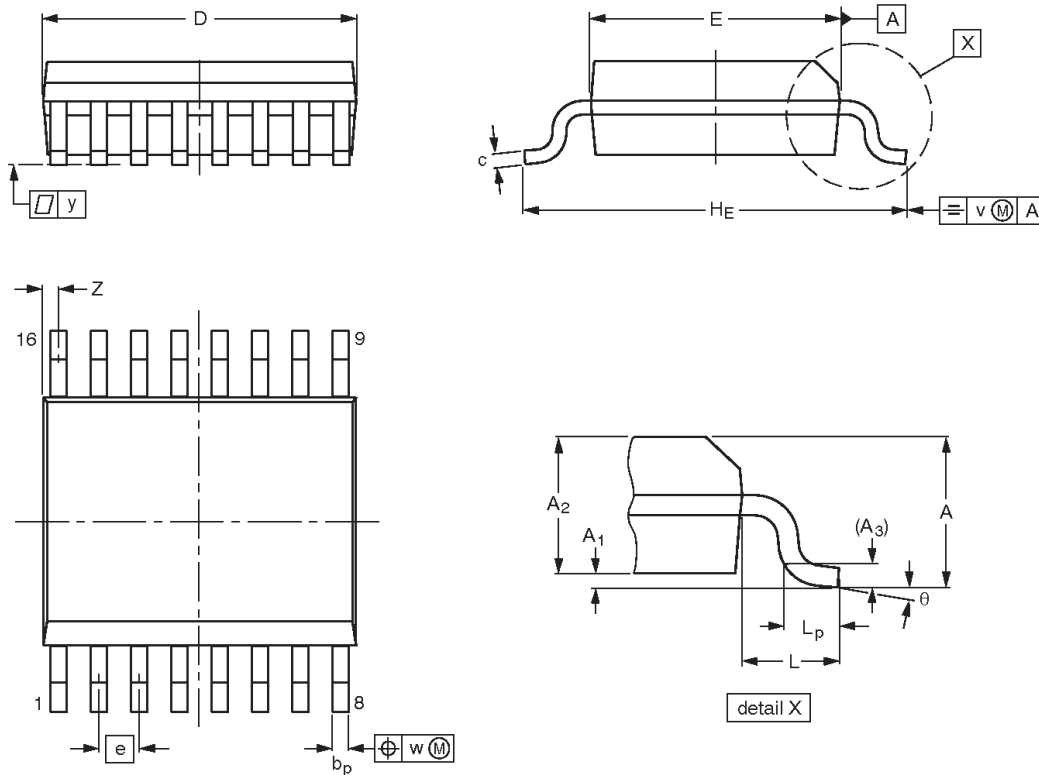

DIMENSIONS (mm are the original dimensions)

UNIT	A max.	A ₁	A ₂	A ₃	b _p	c	D ⁽¹⁾	E ⁽¹⁾	e	H _E	L	L _p	v	w	y	Z ⁽¹⁾	θ
mm	1.73	0.25 0.10	1.55 1.40	0.25	0.31 0.20	0.25 0.18	5.0 4.8	4.0 3.8	0.635	6.2 5.8	1.0	0.89 0.41	0.2	0.18	0.09	0.18 0.05	8° 0°

Note

1. Plastic or metal protrusions of 0.20 mm maximum per side are not included.

OUTLINE VERSION	REFERENCES				EUROPEAN PROJECTION	ISSUE DATE
	IEC	JEDEC	EIAJ			
SOT519-1						99-05-04

Temperature monitor for microprocessor systems

NE1618

NOTES

Temperature monitor for microprocessor systems

NE1618

Data sheet status

Data sheet status ^[1]	Product status ^[2]	Definitions
Objective data	Development	This data sheet contains data from the objective specification for product development. Philips Semiconductors reserves the right to change the specification in any manner without notice.
Preliminary data	Qualification	This data sheet contains data from the preliminary specification. Supplementary data will be published at a later date. Philips Semiconductors reserves the right to change the specification without notice, in order to improve the design and supply the best possible product.
Product data	Production	This data sheet contains data from the product specification. Philips Semiconductors reserves the right to make changes at any time in order to improve the design, manufacturing and supply. Changes will be communicated according to the Customer Product/Process Change Notification (CPCN) procedure SNW-SQ-650A.

[1] Please consult the most recently issued data sheet before initiating or completing a design.

[2] The product status of the device(s) described in this data sheet may have changed since this data sheet was published. The latest information is available on the Internet at URL <http://www.semiconductors.philips.com>.

Definitions

Short-form specification — The data in a short-form specification is extracted from a full data sheet with the same type number and title. For detailed information see the relevant data sheet or data handbook.

Limiting values definition — Limiting values given are in accordance with the Absolute Maximum Rating System (IEC 60134). Stress above one or more of the limiting values may cause permanent damage to the device. These are stress ratings only and operation of the device at these or at any other conditions above those given in the Characteristics sections of the specification is not implied. Exposure to limiting values for extended periods may affect device reliability.

Application information — Applications that are described herein for any of these products are for illustrative purposes only. Philips Semiconductors make no representation or warranty that such applications will be suitable for the specified use without further testing or modification.

Disclaimers

Life support — These products are not designed for use in life support appliances, devices or systems where malfunction of these products can reasonably be expected to result in personal injury. Philips Semiconductors customers using or selling these products for use in such applications do so at their own risk and agree to fully indemnify Philips Semiconductors for any damages resulting from such application.

Right to make changes — Philips Semiconductors reserves the right to make changes, without notice, in the products, including circuits, standard cells, and/or software, described or contained herein in order to improve design and/or performance. Philips Semiconductors assumes no responsibility or liability for the use of any of these products, conveys no license or title under any patent, copyright, or mask work right to these products, and makes no representations or warranties that these products are free from patent, copyright, or mask work right infringement, unless otherwise specified.

Contact information

For additional information please visit
<http://www.semiconductors.philips.com>. Fax: +31 40 27 24825

© Koninklijke Philips Electronics N.V. 2002
 All rights reserved. Printed in U.S.A.

Date of release: 01-02

For sales offices addresses send e-mail to:
sales.addresses@www.semiconductors.philips.com

Document order number:

9397 750 09274

Let's make things better.

Looking for pricing, stock, or lifecycle information?

Click below to explore more details on WIN SOURCE:

 [View NE1618DS,112 on WIN SOURCE](#)

 [NXP / Nexperia Information](#)

Optimize Your Supply Chain with WIN SOURCE Solutions

-  Global Sourcing Solution
-  Obsolete Management
-  Cost Control Management
-  Shortage Management
-  Alternative Solution
-  Excess Inventory Management