



# THE DATASHEET OF NF2EB-48V



**Panasonic**  
ideas for life

**FLATPACK RELAY**

**NF-RELAYS**

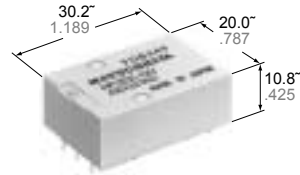

mm inch

## FEATURES

1. Flatpack
2. Long seller

## SPECIFICATIONS

### Contacts

Arrangement	2 Form C, 4 Form C		
Initial contact resistance (By voltage drop 6 V DC 1 A)	Max.	50 mΩ	
	Typical	25 mΩ	
Contact material	Movable contact	Gold-clad silver	
	Stationary contact	Gold-clad silver	
Rating, (resistive load)	Max. switching power	60 W 100 VA	
	Max. switching voltage	220 V AC, DC	
	Max. switching current	2 A	
Expected life (min. operations)	Mechanical	10 <sup>8</sup>	
	Electrical (Resistive)	2 A 30 V DC	2 × 10 <sup>5</sup>
		1 A 30 V DC	10 <sup>6</sup>
	0.5 A 30 V DC	10 <sup>7</sup>	

### Coil

Nominal operating power, at 25°C	2C	Approx. 300 mW
	4C	Approx. 480 mW
Max. operating power for continuous duty	Approx. 1 W at 40°C 104°F	

### Remarks

- \* Specifications will vary with foreign standards certification ratings.
- \*<sup>1</sup> Measurement at same location as "Initial breakdown voltage" section
- \*<sup>2</sup> Detection current: 10 mA
- \*<sup>3</sup> Excluding contact bounce time
- \*<sup>4</sup> Half-wave pulse of sine wave: 11ms; detection time: 10μs
- \*<sup>5</sup> Half-wave pulse of sine wave: 6ms
- \*<sup>6</sup> Detection time: 10μs
- \*<sup>7</sup> Refer to 5. Conditions for operation, transport and storage mentioned in AMBIENT ENVIRONMENT in catalog.

### Characteristics (at 25°C 77°F, 50% R.H. seal level)

Max. operating speed		50 cps
Initial insulation resistance* <sup>1</sup>		1,000 MΩ at 500 V DC
Electrostatic capacitance	Contact/Contact	Approx. 4 pF
	Contact/Coil	Approx. 7 pF
	Contact/Ground	Approx. 6 pF
Initial breakdown voltage* <sup>2</sup>	Between open contacts	750 Vrms
	Between contact sets	1,000 Vrms
	Between live parts and ground	1,000 Vrms
	Between contacts and coil	1,000 Vrms
Operate time* <sup>3</sup> (at nominal voltage)		Max. 15 ms (Approx. 10 ms)
Release time (without diode)* <sup>3</sup> (at nominal voltage)		Max. 10 ms (Approx. 3 ms)
Contact bounce		Approx. 1.5 ms
Shock resistance	Functional* <sup>4</sup>	In de-energized condition Min. 29.4 m/s <sup>2</sup> {3 G} (In contact direction) Min. 98 m/s <sup>2</sup> {10 G} (perpendicular to contact)
		In energized condition Min. 196 m/s <sup>2</sup> {20 G}
	Destructive* <sup>5</sup>	Min. 980 m/s <sup>2</sup> {100 G}
Vibration resistance	Functional* <sup>6</sup>	In de-energized condition 29.4 m/s <sup>2</sup> {3 G}, 10 to 55 Hz at double amplitude of 0.5 mm (in contact direction) 98 m/s <sup>2</sup> {10 G} 10 to 55 Hz at double amplitude of 1.6 mm (perpendicular to contact)
		In energized condition 117.6 m/s <sup>2</sup> {12 G} 10 to 55 Hz at double amplitude of 2 mm
	Destructive	196 m/s <sup>2</sup> {20 G}, 10 to 55 Hz at double amplitude of 3.3 mm
Conditions for operation, transport and storage* <sup>7</sup> (Not freezing and condensing at low temperature)	Ambient temp.	-40°C to +65°C -40°F to +149°F
	Humidity	5 to 85%R.H.
Unit weight	2C	Approx. 14 g .49 oz
	4C	Approx. 15.5 g .55 oz

## TYPICAL APPLICATIONS

NF relays are widely acceptable in applications where small size and high sensitivity are required.

Such applications include: Electronic equipment, Household applications,

Alarm systems, Office machines, Communication equipment, Measuring equipment, Remote control systems, General control circuits, Machine tools, Industrial machinery, etc.

## ORDERING INFORMATION

Ex. NF 4 EB — 4M — 48V — 1

Contact arrangement	Type classification	-	Coil voltage (DC)	Contact material
2: 2 Form C 4: 4 Form C	EB: Standard	-	5, 6, 12, 24, 48 V	Nil: Gold-clad silver 1: Gold-cap over silver palladium

- (Notes) 1. For VDE recognized types, add suffix VDE.  
 2. For UL/CSA recognized type, add suffix-A, as NF2EB-12V-A whose ground terminal is cut off.  
 3. Standard packing Carton: 20 pcs.; Case: 200 pcs.

## TYPES AND COIL DATA (at 25°C 77°F)

\*Less than 1,000 Ω: ±10%  
 \*More than 1,000 Ω: ±15%

Part No.	Nominal voltage, V DC	Pick-up voltage, V DC (max.)	Drop-out voltage, V DC (min.)	Max. allowable voltage, V DC (at 40°C)	Coil resistance,* Ω	Nominal operating power, mW	Inductance, H	
							Open	Close
NF2EB-5V	5	4.0	0.5	8.7	90	278	0.071	0.071
NF2EB-6V	6	4.8	0.6	10.5	137	260	0.093	0.094
NF2EB-12V	12	9.6	1.2	21	500	290	0.338	0.344
NF2EB-24V	24	19.2	2.4	42	2,000	290	1.29	1.31
NF2EB-48V	48	38.4	4.8	84	7,000	330	4.12	4.18
NF4EB-5V	5	4.0	0.5	7	53	472	0.029	0.029
NF4EB-6V	6	4.8	0.6	8.5	90	400	0.070	0.071
NF4EB-12V	12	9.6	1.2	17.0	330	440	0.22	0.23
NF4EB-24V	24	19.2	2.4	34	1,200	480	0.77	0.79
NF4EB-48V	48	38.4	4.8	68	4,200	550	2.22	2.25

## DIMENSIONS

mm inch

## 2 Form C

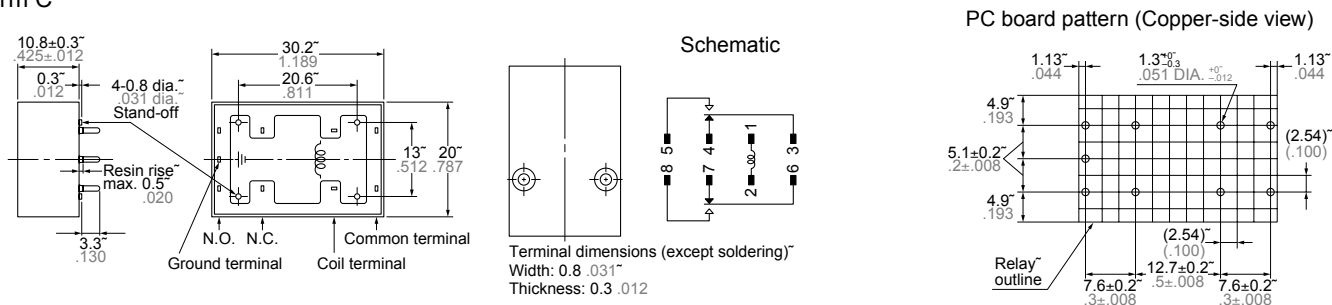

## 4 Form C

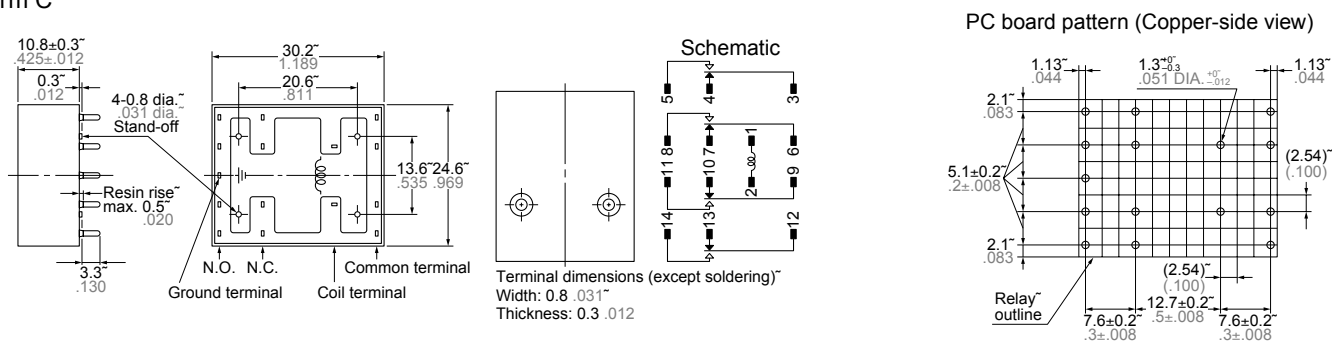

General tolerance:  $\pm 0.5 \pm .020$   
 (Except for the cover height)

REFERENCE DATA

1. Life curve

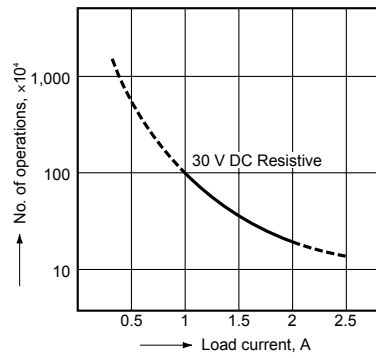

2. Coil temperature rise (resistance method)

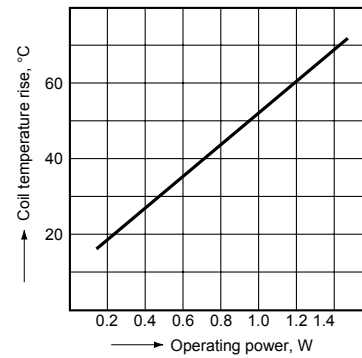

3. H<sub>2</sub>S gas test

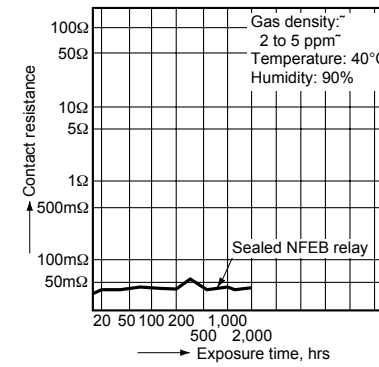

4. Contact reliability

Test conditions:

1. Contact current/voltage: 10 μA 100 mV 1 kHz
2. Cycle rate 20 cps.
3. Miscontact detection level: 1 mW (= 100 Ω)
4. Detection method: Observation of all changeover contacts

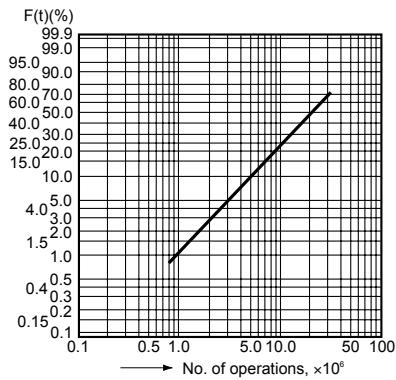

Test result:

- m = 1.5
- $\mu = 21.2 \times 10^6$
- 95% confidence level =  $3.1 \times 10^6$
- 17 contacts out of 20 achieved 10 million no miscontact operations.

5. High temperature test

Test conditions:

Ambient temperature: 80°C ±2°C

Test method:

1. All contacts were switched for 100 operations on 2 A 30 V DC resistive load.
2. Samples then were exposed to 80°C temperature for 5,000 hours, continuous
3. Contact resistance was measured with Hewlett-Packard testing equipment.

Test result:

Amber relays showed a stable spread of contact resistance within the initially specified 50 mΩ after 5,000 hours exposure.

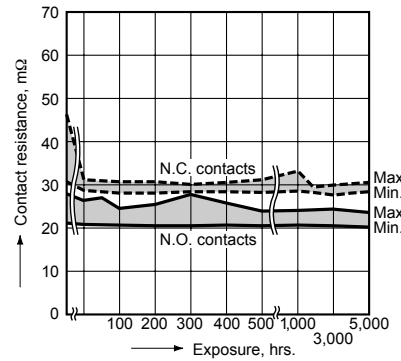

NOTES

1. Prevention of vibration and shock

To reduce the likelihood of vibration and shock, we recommend that you install so that the contact action is not in the direction of gravity.

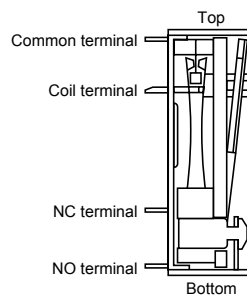

For Cautions for Use, see Relay Technical Information in catalog.

## Looking for pricing, stock, or lifecycle information?

Click below to explore more details on WIN SOURCE:

 [View NF2EB-48V on WIN SOURCE](#)

 [Panasonic Information](#)

## Optimize Your Supply Chain with WIN SOURCE Solutions

-  Global Sourcing Solution
-  Obsolete Management
-  Cost Control Management
-  Shortage Management
-  Alternative Solution
-  Excess Inventory Management