

## SPDT SWITCH GaAs MMIC

### ■GENERAL DESCRIPTION

NJG1505R is a GaAs SPDT switch MMIC which features high isolation and low loss and ideally suitable for switching transmit/receiving signal of synthesizer.

This switch is operated in the wide frequency range from 1MHz to 3GHz at low voltage operation from 2.5V with very small VSP8 package.

### ■PACKAGE OUTLINE

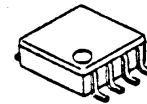

NJG1505R

### ■FEATURES

- Single and low control voltage +2.5~+5.5V
- High isolation 47dB typ. @f=0.05~1GHz,  $P_{in}=0dBm$   
37dB typ. @f=1GHz~2GHz,  $P_{in}=0dBm$
- Low insertion loss 0.6dB typ. @f=1GHz,  $P_{in}=0dBm$   
0.8dB typ. @f=2GHz,  $P_{in}=0dBm$
- Low control current 2uA typ. @f=0.05~2.5GHz,  $P_{in}=10dBm$
- Package VSP8 (Mount Size: 4.0x2.9x1.2mm)

### ■PIN CONFIGURATION

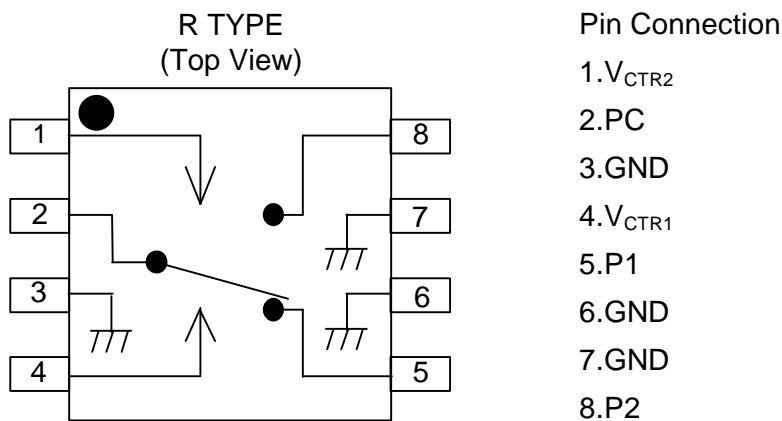

### ■TRUTH TABLE

“H”= $V_{CTR(H)}$ , “L”= $V_{CTR(L)}$

$V_{CTR1}$	H	L	L	H
$V_{CTR2}$	L	H	L	H
PC-P1	OFF	ON	-	-
PC-P2	ON	OFF	-	-

# NJG1505R

## ■ABSOLUTE MAXIMUM RATINGS

( $T_a=25^{\circ}\text{C}$ )

PARAMETER	SYMBOL	RATINGS	UNITS
Input power	$P_{in}$	27	dBm
Control voltage	$V_{CTR}$	6	V
Power dissipation	$P_D$	320	mW
Operating temp.	$T_{opr}$	-30~+85	$^{\circ}\text{C}$
Storage temp.	$T_{stg}$	-40~+150	$^{\circ}\text{C}$

## ■ELECTRICAL CHARACTERISTICS 1

(TEST CIRCUIT 1:  $V_{CTR(L)}=0\text{V}$ ,  $V_{CTR(H)}=2.7\text{V}$ ,  $Z_s=Z_o=50\Omega$ ,  $T_a=25^{\circ}\text{C}$ )

PARAMETER	SYMBOL	CONDITIONS	MIN	TYP	MAX	UNITS
Control voltage (L)	$V_{CTR(L)}$	$f=0.05\sim 2.5\text{GHz}$ , $P_{in}=10\text{dBm}$	-0.2	0	0.2	V
Control voltage (H)	$V_{CTR(H)}$	$f=0.05\sim 2.5\text{GHz}$ , $P_{in}=10\text{dBm}$	2.5	2.7	5.5	V
Control current	$I_{CTR}$	$f=0.05\sim 2.5\text{GHz}$ , $P_{in}=10\text{dBm}$	-	2.0	4.0	$\mu\text{A}$
Isolation 1	ISL1	$f=0.05\sim 1\text{GHz}$ , $P_{in}=0\text{dBm}$	40	47	-	dB
Isolation 2	ISL2	$f=1\text{GHz}\sim 2\text{GHz}$ , $P_{in}=0\text{dBm}$	33	37	-	dB
Insertion loss 1	LOSS1	$f=1\text{GHz}$ , $P_{in}=0\text{dBm}$	-	0.6	1.0	dB
Insertion loss 2	LOSS2	$f=2\text{GHz}$ , $P_{in}=0\text{dBm}$	-	0.8	1.2	dB
Pin at 1dB compression point	$P_{-1\text{dB}}$	$f=2\text{GHz}$	19	22	-	dBm
VSWR	VSWR	$f=0.05\sim 2.5\text{GHz}$ , ON STATE	-	1.5	1.8	
Switching time	$T_{SW}$	$f=0.05\sim 2.5\text{GHz}$	-	8	-	ns

## ■ELECTRICAL CHARACTERISTICS 2

(TEST CIRCUIT 2:  $V_{CTR(L)}=0\text{V}$ ,  $V_{CTR(H)}=2.7\text{V}$ ,  $Z_s=Z_o=50\Omega$ ,  $T_a=25^{\circ}\text{C}$ )

PARAMETER	SYMBOL	CONDITIONS	MIN	TYP	MAX	UNITS
Isolation 3	ISL3	$f=1\sim 100\text{MHz}$ , $P_{in}=0\text{dBm}$	-	55	-	dB
Insertion loss 3	LOSS3	$f=1\sim 100\text{MHz}$ , $P_{in}=0\text{dBm}$	-	0.5	-	dB

## ■ TYPICAL CHARACTERISTICS

### PC-P1 Isolation

( $V_{CTR} = 0V/2.7V$ )

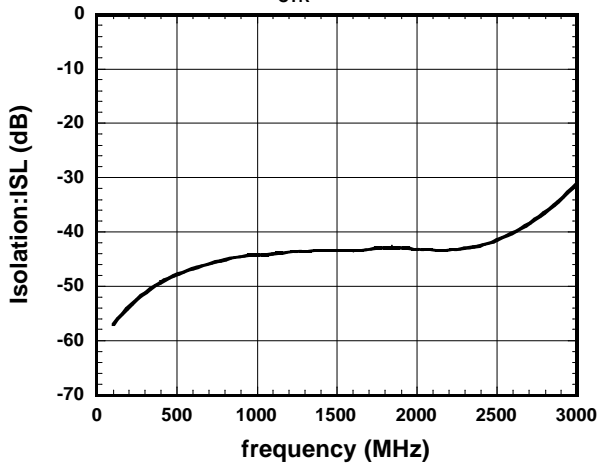

### PC-P2 Isolation

( $V_{CTR} = 0V/2.7V$ )

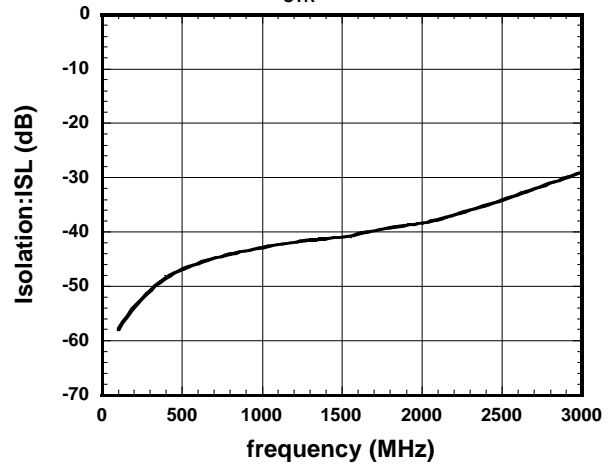

### PC-P1 Insertion Loss

0.1-3GHz  
( $V_{CTR} = 0V/2.7V$ )

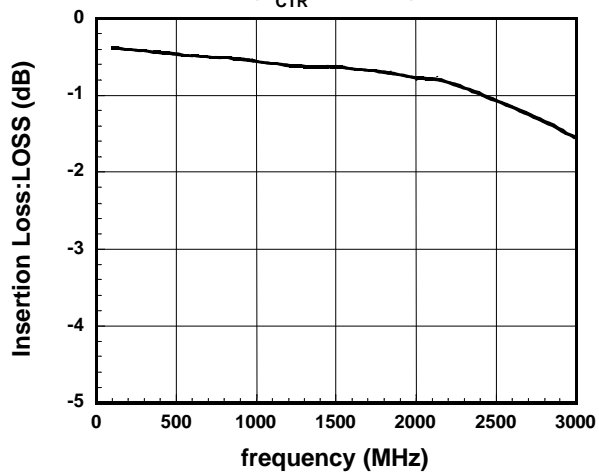

### PC-P2 Insertion Loss

0.1-3GHz  
( $V_{CTR} = 0V/2.7V$ )

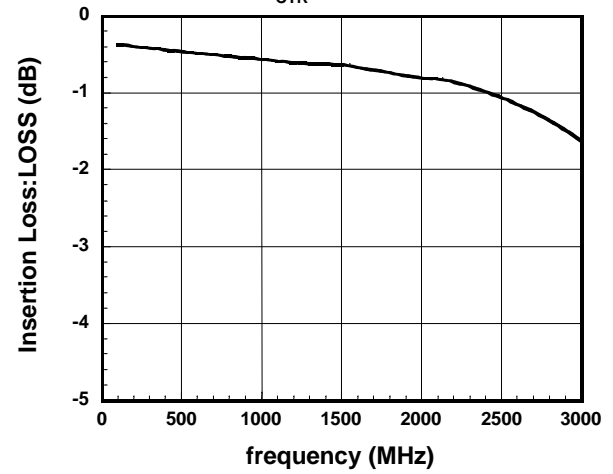

# NJG1505R

## ■ TYPICAL CHARACTERISTICS

### PC-P1 Isolation

1-100MHz  
( $V_{CTR}=0V/2.7V$ )

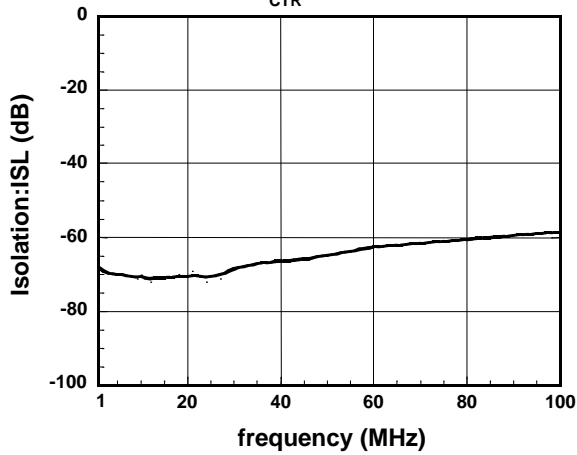

### PC-P2 Isolation

1-100MHz  
( $V_{CTR}=0V/2.7V$ )

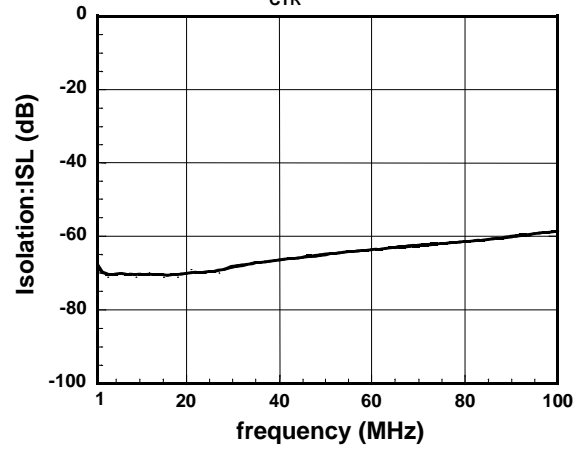

### PC-P1 Insertion Loss

1-100MHz  
( $V_{CTR}=0V/2.7V$ )

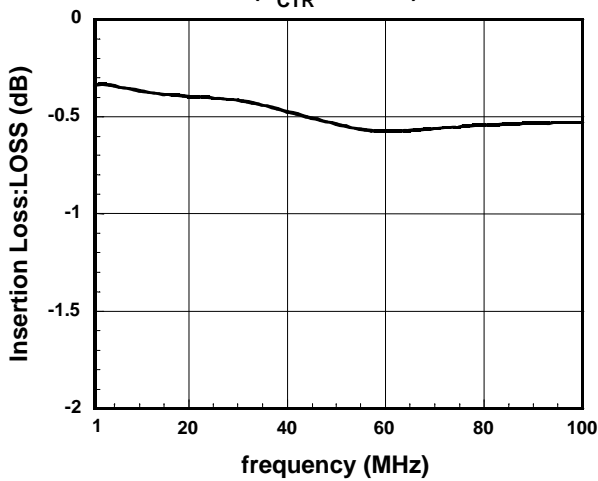

### PC-P2 Insertion Loss

1-100MHz  
( $V_{CTR}=0V/2.7V$ )

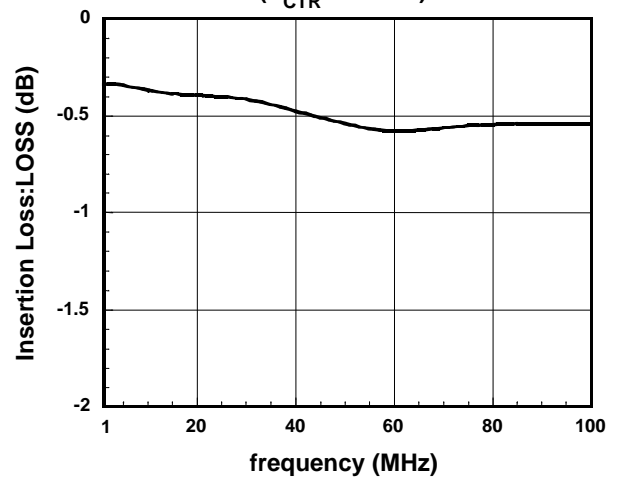

## TYPICAL CHARACTERISTICS

### Insertion Loss vs. Input Power ( $V_{CTR}=0V/2.7V, f_{in}=2GHz$ )

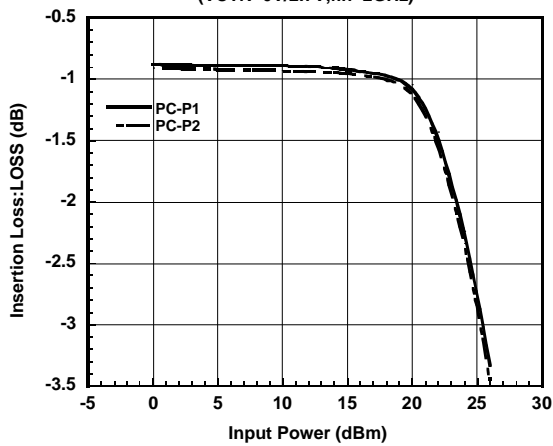

### Isolation vs. Input Power ( $V_{CTR}=0V/2.7V, f_{in}=2GHz$ )

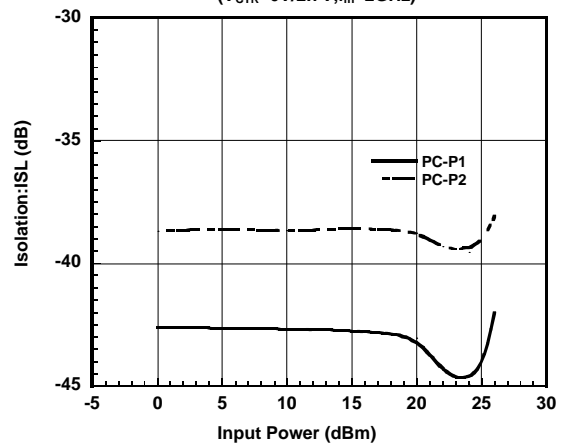

### (PC-P1) Output Power vs. Input Power ( $V_{CTR}=0V/2.7V, f_{in}=2GHz$ )

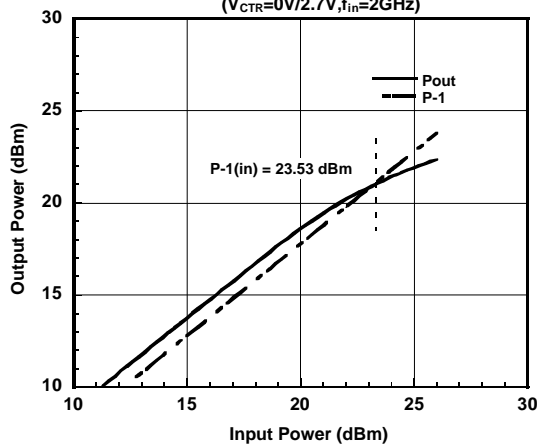

### (PC-P2) Output Power vs. Input Power ( $V_{CTR}=0V/2.7V, f_{in}=2GHz$ )

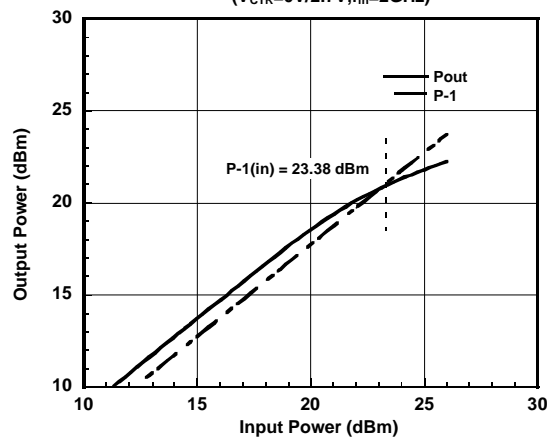

### (PC-P1) Control Current vs. Input Power ( $f_{in}=2GHz$ )

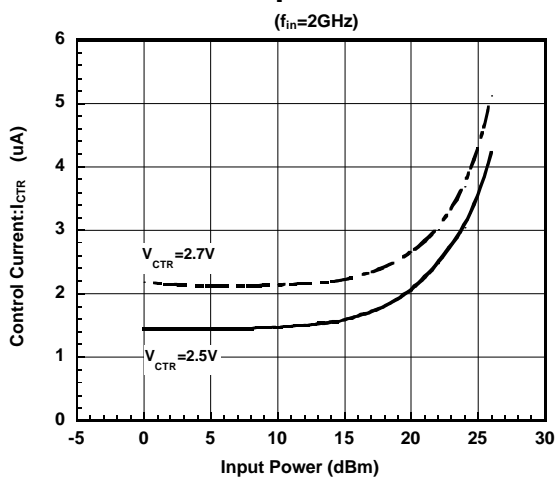

### (PC-P2) Control Current vs. Input Power ( $f_{in}=2GHz$ )

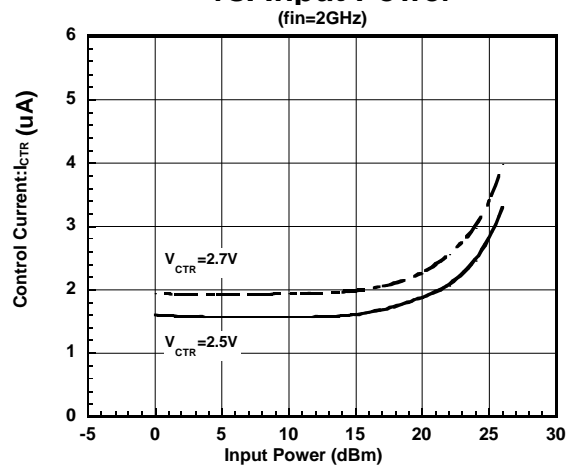

## TYPICAL CHARACTERISTICS

Isolation v.s. Ambient Temperature  
(f<sub>in</sub>=1GHz, V<sub>CTR(L)</sub>=0V)

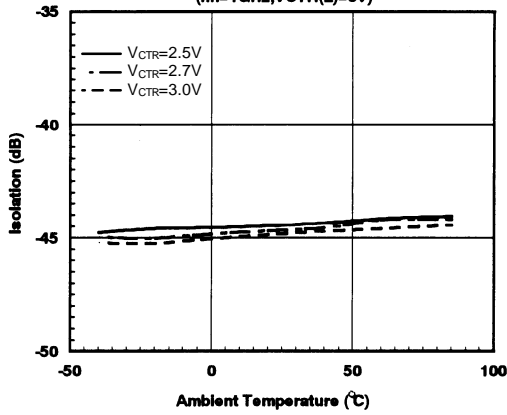

Isolation v.s. Ambient Temperature  
(f<sub>in</sub>=2GHz, V<sub>CTR(L)</sub>=0V)

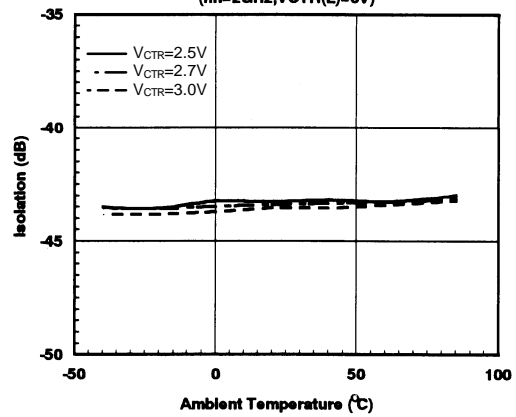

Insertion Loss v.s. Ambient Temperature  
(f<sub>in</sub>=1GHz, V<sub>CTR(L)</sub>=0V)

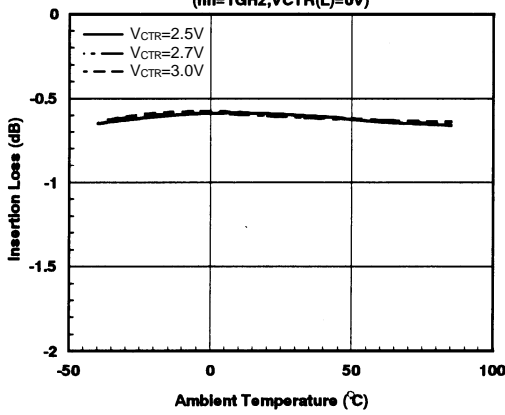

Insertion Loss v.s. Ambient Temperature  
(f<sub>in</sub>=2GHz, V<sub>CTR(L)</sub>=0V)

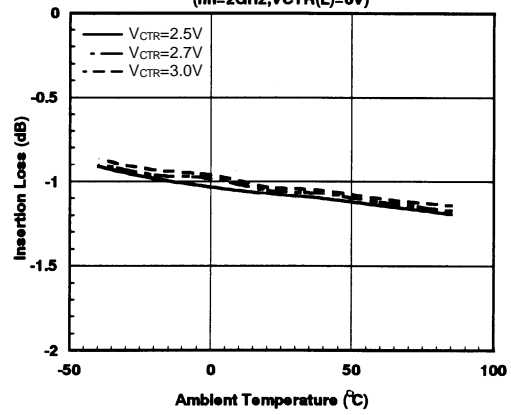

1dB compression Input Power v.s. Ambient Temperature  
(f<sub>in</sub>=2GHz, V<sub>CTR(L)</sub>=0V)

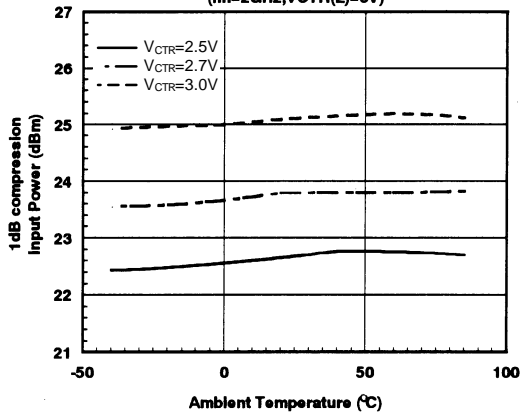

Control Current v.s. Ambient Temperature  
(f<sub>in</sub>=2GHz, V<sub>CTR(L)</sub>=0V)

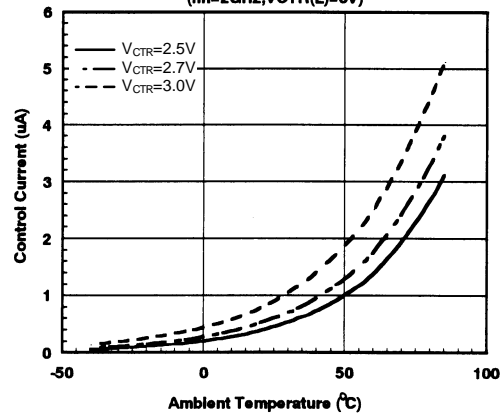

■APPLICATION CIRCUIT: Single control signal operation by using C-MOS inverter.

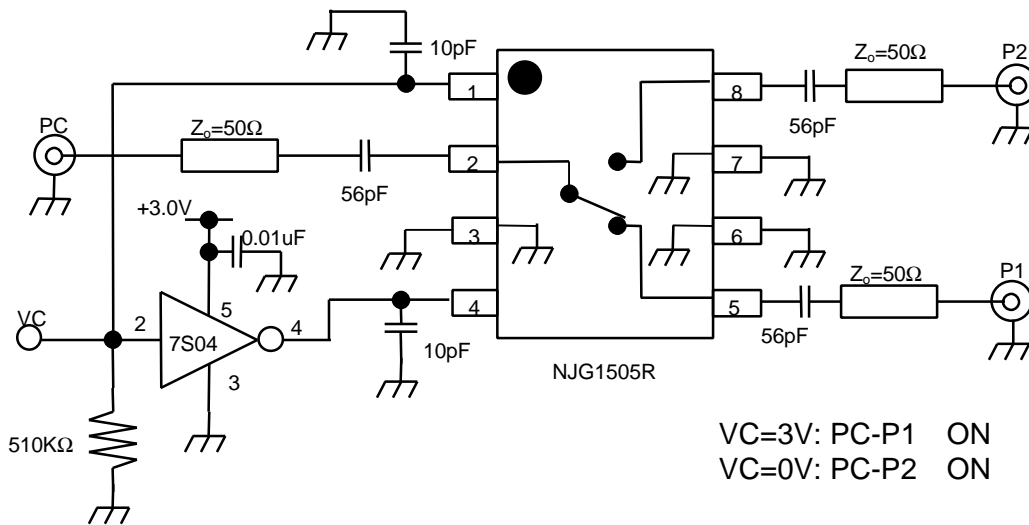

- [1] Please connect bypass capacitors to the supply terminals of the C-MOS inverter.
- [2] In order to stabilize input impedance of inverter, please pull down using 510KΩ resistor from the input terminal of the C-MOS inverter to the ground plane.

■TEST CIRCUIT

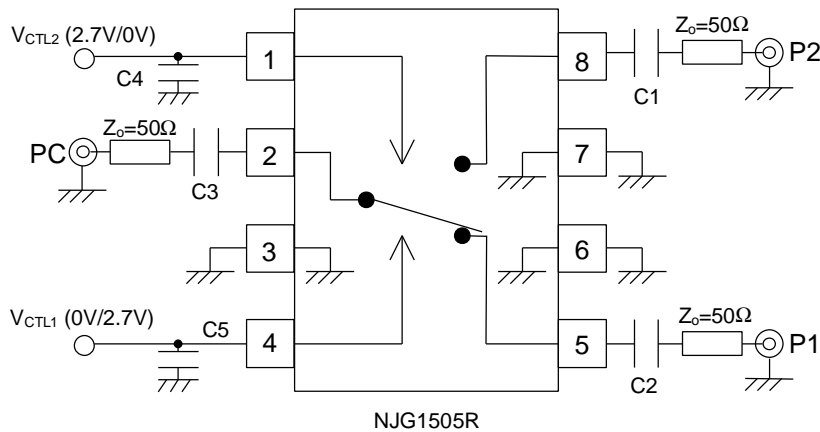

	Test circuit 1 0.5~2GHz	Test circuit 2 1~500MHz
C1~C3	56pF	0.1uF
C4, C5	10pF	1000pF

# NJG1505R

## RECOMMENDED PCB DESIGN

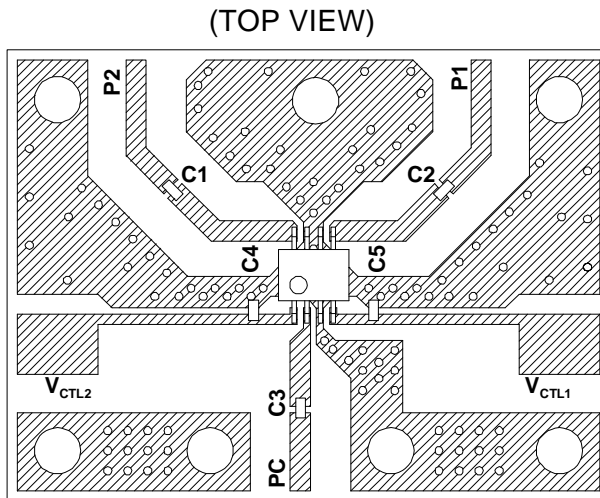

PCB SIZE=30.0x22.5mm

PCB: FR-4, t=0.5mm

STRIPLINE WIDTH=1mm

CAPACITORS: size 1005

### Precautions

- [1] External capacitors should be connected to the input and output RF terminals (P1, P2, PC) to block the DC current. The values of these capacitors depend on RF frequency range. Please use a 0.01uF capacitor at 50 to 100MHz, a 0.1uF capacitor at 100 to 500MHz, and a 56pF capacitor at 500MHz to 2GHz.
- [2] Decoupling capacitors should be connected to the control terminals ( $V_{CTR1}$ ,  $V_{CTR2}$ ) as close as possible. The values of these capacitors should be selected to 0.01uF at 50 to 100MHz, 0.1uF at 100 to 500MHz, and 10pF at 500MHz to 2GHz. Please take care to select these values because the capacitors make switching time long.
- [3] In order to keep good isolation characteristics, the ground terminals (3, 6, 7 pin) should be connected to ground pattern with wider width as close as possible, and through-hole in the ground plane should also be placed as close as possible.
- [4] The isolation of PC port to P1 port is greater than the isolation of PC port to P2 port. Please consider this information to create better isolation design.

## PACKAGE OUTLINE (VSP8)

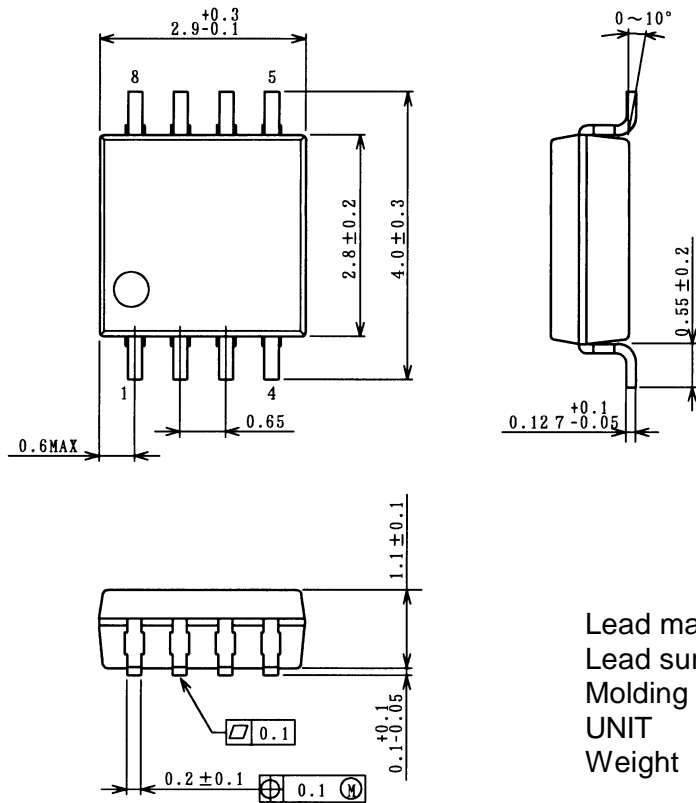

Lead material	: Copper
Lead surface finish	: Solder plating
Molding material	: Epoxy resin
UNIT	: mm
Weight	: 22mg

### Cautions on using this product

This product contains Gallium-Arsenide (GaAs) which is a harmful material.

- Do NOT eat or put into mouth.
- Do NOT dispose in fire or break up this product.
- Do NOT chemically make gas or powder with this product.
- To waste this product, please obey the relating law of your country.



### [CAUTION]

The specifications on this databook are only given for information, without any guarantee as regards either mistakes or omissions. The application circuits in this databook are described only to show representative usages of the product and not intended for the guarantee or permission of any right including the industrial rights.

This product may be damaged with electric static discharge (ESD) or spike voltage. Please handle with care to avoid these damages.

## Looking for pricing, stock, or lifecycle information?

Click below to explore more details on WIN SOURCE:

-  [View NJG1505R\(TE1\) on WIN SOURCE](#)
-  [NJR Corporation/NJRC Information](#)

## Optimize Your Supply Chain with WIN SOURCE Solutions

-  Global Sourcing Solution
-  Obsolete Management
-  Cost Control Management
-  Shortage Management
-  Alternative Solution
-  Excess Inventory Management