

## LOW VOLTAGE DC MOTOR CONTROLLER

### ■ GENERAL DESCRIPTION

The **NJM2606/06A** are integrated circuits with wide operating supply voltage range for DC motor speed control. Especially, the **NJM2606A** is suited for the applications requiring low saturation output voltage.

### ■ PACKAGE OUTLINE

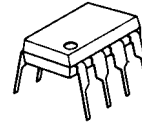

**NJM2606D**  
**NJM2606AD**



**NJM2606M**  
**NJM2606AM**

### ■ FEATURES

- Operating Voltage (1.8V to 8V)
- Internal Low Saturation Voltage Output Transistor
- Package Outline DIP8, DMP8
- Bipolar Technology

### ■ PIN CONFIGURATION

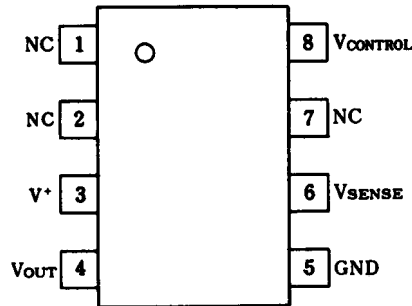

**NJM2606D**  
**NJM2606AD**  
**NJM2606M**  
**NJM2606AM**

### ■ BLOCK DIAGRAM

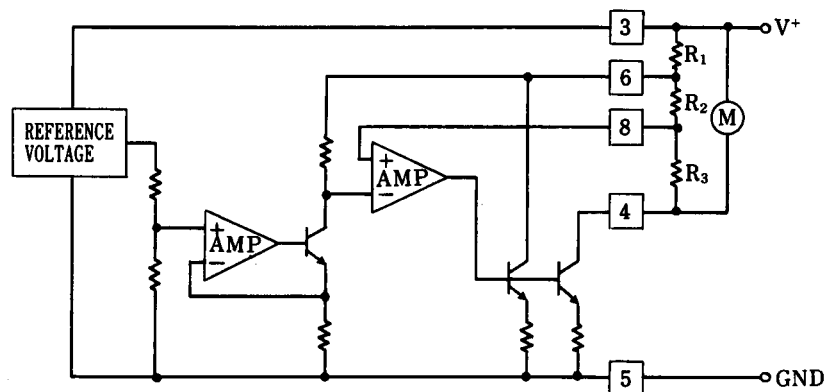

# NJM2606 / 2606A

## ■ ABSOLUTE MAXIMUM RATINGS

(T<sub>a</sub>=25°C)

PARAMETER	SYMBOL	RATINGS	UNIT
Supply Voltage	V <sup>+</sup>	10	V
Peak-to-peak Output Current	I <sub>OP</sub>	700	mA
Power Dissipation	P <sub>D</sub>	(DIP) 500	mW
		(DMP8) 300	mW
Operating Temperature Range	T <sub>opr</sub>	-20 to 75	°C
Storage Temperature Range	T <sub>stg</sub>	-40 to 125	°C

(note)At SW ON. (3 sec. at motor locked or 100msec at duty factor less than 0.1%)

## ■ ELECTRICAL CHARACTERISTICS

(T<sub>a</sub>=25°C, V<sup>+</sup>=3V, I<sub>M</sub>=100mA)

PARAMETER	SYMBOL	TEST CONDITION	MIN.	TYP.	MAX.	UNIT
Operating Current	I <sub>CC</sub>		-	2.4	6.0	mA
Output Saturation Voltage						
NJM2606	V <sub>OSAT</sub>		-	0.18	0.3	V
NJM2606A	V <sub>OSAT</sub>		-	0.13	0.18	V
Reference Voltage	V <sub>REF</sub>		0.18	0.20	0.22	V
vs. Operating Voltage	ΔV <sub>RSV</sub>	V <sup>+</sup> =1.8V to 8.0V	-	0.7	8.0	mV
vs. Output Current	ΔV <sub>ROC</sub>	I <sub>M</sub> =20mA to 200mA	-	2.7	9.0	mV
vs. Ambient Temperature	ΔV <sub>RT</sub>	T <sub>a</sub> = -20°C to +75°C	-	0.04	-	mV / °C
Current Ratio	K	I <sub>M</sub> =50mA to 150mA	45	50	55	
vs. Operating Voltage	ΔK <sub>SV</sub>	V <sup>+</sup> =1.8V to 8.0V I <sub>M</sub> =50mA to 150mA	-	0.6	3.0	
vs. Output Current	ΔK <sub>OC</sub>	I <sub>M</sub> =(20 to 50)mA to (170 to 200)mA	-	1.0	4.0	
vs. Ambient Temperature	ΔK <sub>TC</sub>	T <sub>a</sub> = -20°C to +75°C I <sub>M</sub> =50mA to 150mA	-	1.0	-	1 / °C

## ■ TYPICAL CHARACTERISTICS

### Reference Voltage vs. Operating Voltage

( $I_M=100\text{mA}$ ,  $T_a=25^\circ\text{C}$ )

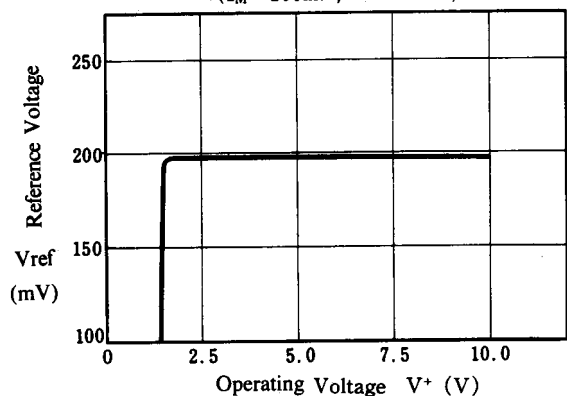

### Reference Voltage vs. Motor Current

( $V^+=3\text{V}$ ,  $T_a=25^\circ\text{C}$ )

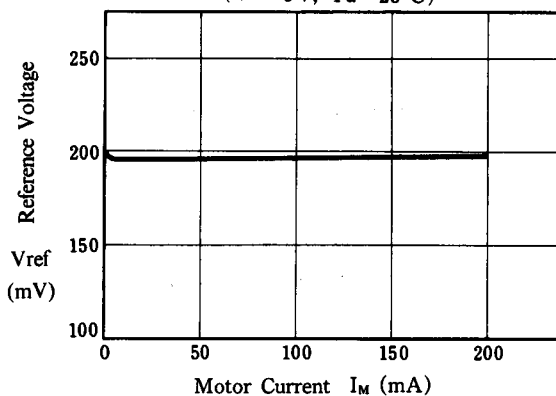

### Reference Voltage vs. Temperature

( $V^+=3\text{V}$ )

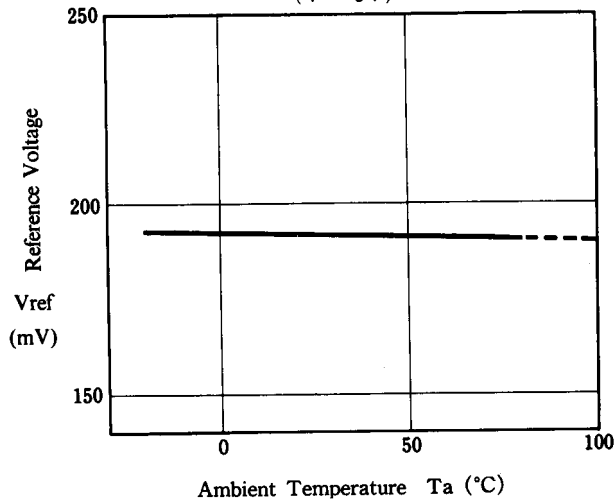

### Operating Current vs. Operating Voltage

( $T_a=25^\circ\text{C}$ )

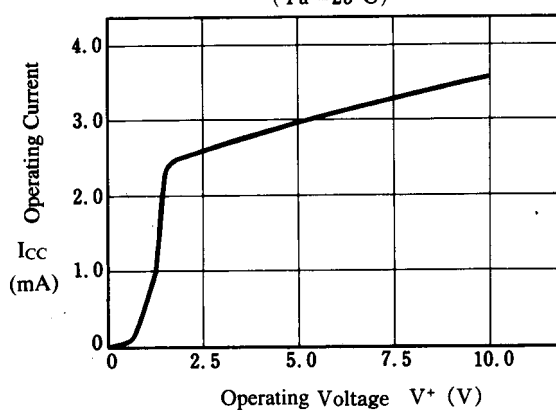

### Output Saturation Voltage vs. Motor Current

( $V^+=3\text{V}$ ,  $T_a=25^\circ\text{C}$ )

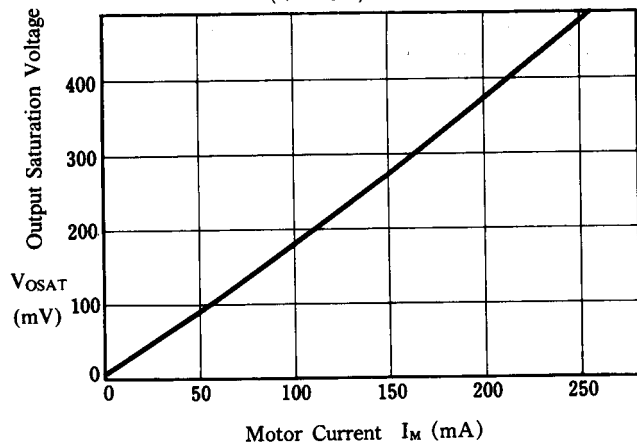

### Current Ratio vs. Operating Voltage

( $I_M=50-150\text{mA}$ ,  $T_a=25^\circ\text{C}$ )

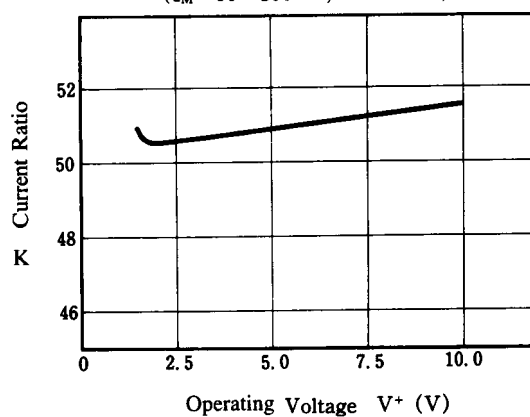

# NJM2606 / 2606A

## ■ TYPICAL CHARACTERISTICS

Current Ratio vs. Motor Current

( $V^+ = 3V$ ,  $T_a = 25^\circ C$ )

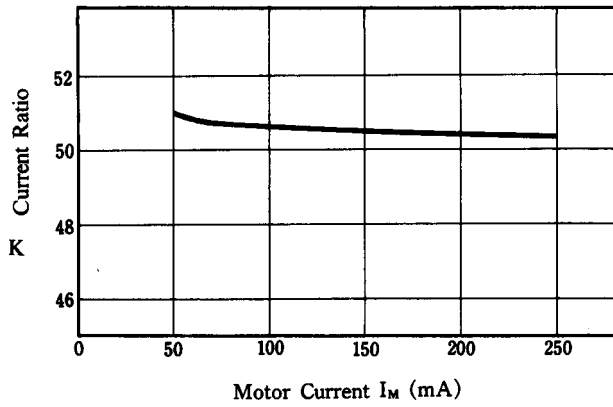

Current Ratio vs. Temperature

( $V^+ = 3V$ ,  $I_M = 50 \sim 150mA$ )

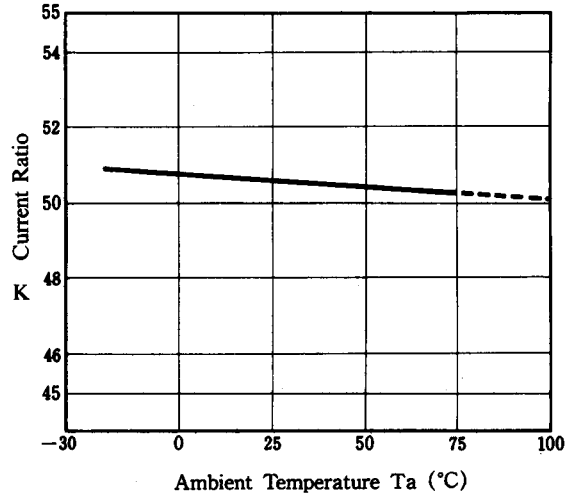

Rotation vs. Torque

( $V^+ = 3V$ ,  $T_a = 25^\circ C$ )

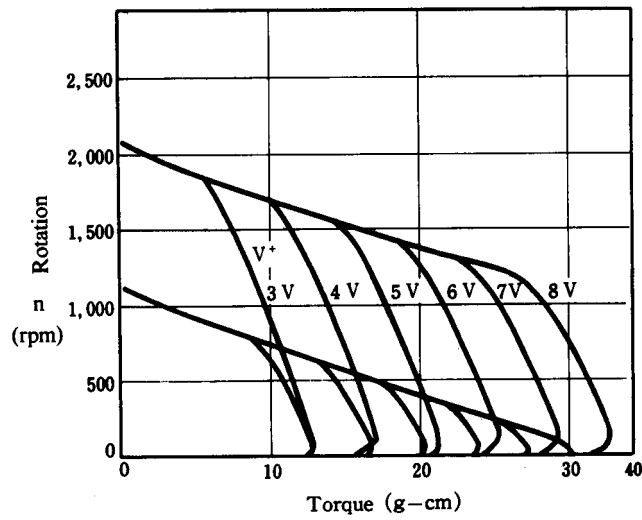

■ TYPICAL APPLICATION

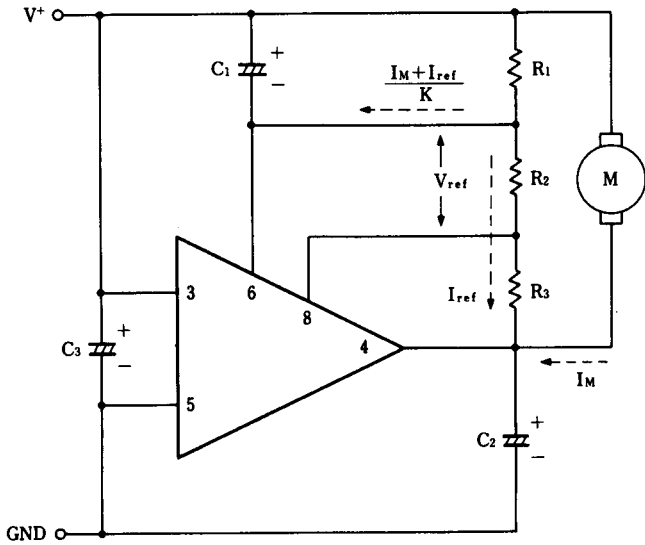

Select C<sub>1</sub>, C<sub>2</sub>, C<sub>3</sub> for each motor type.

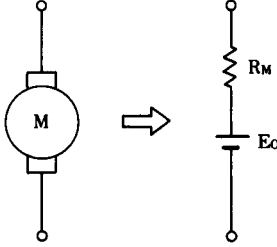

- V<sub>ref</sub> : Reference Voltage
- K : Current Ratio
- I<sub>M</sub> : Motor Current
- R<sub>M</sub> : Internal Resistance of Motor
- E<sub>O</sub> : Motor Counter Electromotive Voltage

The voltage applied at the motor is set as V<sub>M</sub>, which brings the following formula.

$$V_M = (R_1 + R_2 + R_3) I_{ref} + R_1 \cdot \frac{I_M + I_{ref}}{K}$$

Now that, I<sub>ref</sub> = V<sub>ref</sub> / R<sub>2</sub> so that, (I<sub>ref</sub> ≐ 100μA setting is appropriate)

$$V_M = \frac{V_{ref}}{R_2} (R_1 + \frac{R_1}{K} + R_2 + R_3) + \frac{R_1}{K} I_M \quad (1)$$

On the other hand, the voltage applied at the motor itself will be as in the following.

$$V_M = E_O + R_M \cdot I_M \quad (2)$$

Through (1), (2), and then leading to stabilize the control system.

$$R_M \cdot I_M > \frac{R_1}{K} \cdot I_M$$

$$\therefore R_1 < K \cdot R_M \quad (3)$$

Taking in consideration of deviations, R<sub>1(MAX)</sub> < K<sub>(MIN)</sub> · R<sub>M(MIN)</sub> with the condition.

Items required checking in regard to the temperature coefficient

IC items

1. Reference voltage : Temperature coefficient of V<sub>ref</sub>.
2. Current Ratio : Temperature coefficient of K  
\*1 External component items
3. Temperature coefficient of R<sub>1</sub>, R<sub>2</sub> and R<sub>3</sub>  
The relation among these 3 parts takes the very important roll.
4. Temperature coefficient of motor internal resistance
5. Temperature coefficient of motor generative voltage
6. Temperature coefficient ratio of R<sub>1</sub> and R<sub>M</sub>  
Count up from 3.4.

[CAUTION]  
The specifications on this databook are only given for information, without any guarantee as regards either mistakes or omissions. The application circuits in this databook are described only to show representative usages of the product and not intended for the guarantee or permission of any right including the industrial rights.

## Looking for pricing, stock, or lifecycle information?

Click below to explore more details on WIN SOURCE:

- ⊖ [View NJM2606AM-TE1-#ZZZB on WIN SOURCE](#)
- ⊖ [NJR Corporation/NJRC Information](#)

## Optimize Your Supply Chain with WIN SOURCE Solutions

- ✓ Global Sourcing Solution
- ✓ Obsolete Management
- ✓ Cost Control Management
- ✓ Shortage Management
- ✓ Alternative Solution
- ✓ Excess Inventory Management