

## Full-Swing Input and Output type Dual Operational Amplifier

### ■ GENERAL DESCRIPTION

NJM2732 is dual operational amplifier with full swing input and output, operate from 1.8V.  
 Input and Output Full Swing provides wide dynamic range, is from ground to power supply level. In addition to ground sensing applications, NJM2732 enable to be applied to Hi-side sensing applications.

The features are low noise and low operating voltage for battery management, portable audio applications, and others.

### ■ FEATURES

- Operating Voltage : 1.8 to 6.0V
- Input Full-Swing :  $V_{ICM} = 0$  to 5.0V, at  $V^+ = 5V$
- Output Full-Swing :  $V_{OH} \geq 4.9V$  /  $V_{OL} \leq 0.1V$ , at  $V^+ = 5V$ ,  $R_L = 20k\Omega$
- Load Drivability :  $V_{OH} \geq 4.75V$  /  $V_{OL} \leq 0.25V$ , at  $V^+ = 5V$ ,  $R_L = 2k\Omega$
- Offset Voltage : 5mV max.
- Slew Rate : 0.4V/ $\mu$ s typ.
- Low Input Voltage Noise : 10nV/ $\sqrt{Hz}$  typ.
- Adequate phase margin :  $\Phi_M = 75$ deg. typ., at  $R_L = 2k\Omega$ , voltage follower
- Bipolar Technology
- Package Outline : DIP8, DMP8, EMP8, SSOP8, TVSP8

### ■ PACKAGE OUTLINE



NJM2732D



NJM2732M



NJM2732E



NJM2732V



NJM2732RB1

### ■ PIN CONFIGURATION

(Top View)

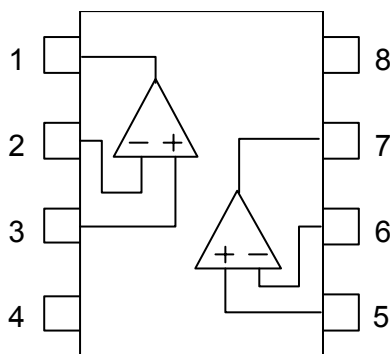

#### PIN FUNCTION

- 1. A OUTPUT
- 2. A -INPUT
- 3. A +INPUT
- 4. GND
- 5. B +INPUT
- 6. B -INPUT
- 7. B OUTPUT
- 8. V<sup>+</sup>

- NJM2732D
- NJM2732M
- NJM2732E
- NJM2732V
- NJM2732RB1

# NJM2732

## ■ ABSOLUTE MAXIMUM RATINGS

(Ta=25°C)

PARAMETER	SYMBOL	RATINGS	UNIT
Supply Voltage	$V^+$	7.0	V
Differential Input Voltage Range	$V_{ID}$	$\pm 1.0$	V
Common Mode Input Voltage Range	$V_{IC}$	0 ~ 7.0 (Note1)	V
Power Dissipation	$P_D$	(DIP8) 500 (DMP8) 300 (EMP8) 320 (SSOP8) 250 (TVSP8) 320	mW
Operating Temperature Range	$T_{opr}$	-40~+85	°C
Storage Temperature Range	$T_{stg}$	-40~+125	°C

(Note1) For supply voltage less than 7V, the absolute maximum input voltage is equal to the supply voltage.

## ■ RECOMMENDED OPERATING CONDITION

(Ta=25°C)

PARAMETER	SYMBOL	RATING	UNIT
Supply Voltage	$V^+$	1.8 to 6.0	V

## ■ ELECTRICAL CHARACTERISTICS ( $V^+=5V$ , Ta=25°C)

### ●DC CHARACTERISTICS

( $V^+=5V$ , Ta=25°C)

PARAMETER	SYMBOL	TEST CONDITION	MIN.	TYP.	MAX.	UNIT
Operating Current	$I_{CC}$	No signal applied	-	580	900	$\mu A$
Input Offset Voltage	$V_{IO}$		-	1	5	mV
Input Bias Current	$I_B$		-	50	250	nA
Input Offset Current	$I_{IO}$		-	5	100	nA
Large Signal Voltage Gain	$A_V$	$R_L=2k\Omega$	60	85	-	dB
Common Mode Rejection Ratio	CMR	CMR+: $2.5V \leq V_{CM} \leq 5V$ CMR-: $0V \leq V_{CM} \leq 2.5V$ (Note2)	55	70	-	dB
Supply Voltage Rejection Ratio	SVR	$V^+/V = \pm 2.0V \sim \pm 3.0V$	70	85	-	dB
Maximum Output Voltage 1	$V_{OH1}$	$R_L=20k\Omega$	4.9	4.95	-	V
	$V_{OL1}$	$R_L=20k\Omega$	-	0.05	0.1	V
Maximum Output Voltage 2	$V_{OH2}$	$R_L=2k\Omega$	4.75	4.85	-	V
	$V_{OL2}$	$R_L=2k\Omega$	-	0.15	0.25	V
Input Common Mode Voltage Range	$V_{ICM}$	CMR $\geq 55$ dB	0	-	5	V

(Note2) CMR is represented by either CMR+ or CMR- has lower value.

CMR+ is measured with  $2.5V \leq V_{CM} \leq 5.0$  and CMR- is measured with  $0V \leq V_{CM} \leq 2.5V$ .

### ●AC CHARACTERISTICS

( $V^+=5V$ , Ta=25°C)

PARAMETER	SYMBOL	TEST CONDITION	MIN.	TYP.	MAX.	UNIT
Unity Gain Bandwidth	GB	$R_L=2k\Omega$	-	1	-	MHz
Phase Margin	$\Phi_M$	$R_L=2k\Omega$	-	75	-	Deg
Equivalent Input Noise Voltage	$V_{NI}$	f=1kHz	-	10	-	nV/ $\sqrt{Hz}$

### ●TRANSIENT CHARACTERISTICS

( $V^+=5V$ , Ta=25°C)

PARAMETER	SYMBOL	TEST CONDITION	MIN.	TYP.	MAX.	UNIT
Slew Rate	SR	$R_L=2k\Omega$	-	0.4	-	V/ $\mu s$

## ■ ELECTRICAL CHARACTERISTICS ( $V^+=3V, T_a=25^\circ C$ )

### ●DC CHARACTERISTICS

( $V^+=3V, T_a=25^\circ C$ )

PARAMETER	SYMBOL	TEST CONDITION	MIN.	TYP.	MAX.	UNIT
Operating Current	$I_{CC}$	No signal applied	-	510	880	$\mu A$
Input Offset Voltage	$V_{IO}$		-	1	5	mV
Input Bias Current	$I_B$		-	50	250	nA
Input Offset Current	$I_{IO}$		-	5	100	nA
Large Signal Voltage Gain	$A_V$	$R_L=2k\Omega$	60	84	-	dB
Common Mode Rejection Ratio	CMR	CMR+: $1.5V \leq V_{CM} \leq 3V$ CMR-: $0V \leq V_{CM} \leq 1.5V$ (Note3)	48	63	-	dB
Supply Voltage Rejection Ratio	SVR	$V^+V^-=\pm 1.2V \sim \pm 2.0V$	68	83	-	dB
Maximum Output Voltage 1	$V_{OH1}$	$R_L=20k\Omega$	2.9	2.95	-	V
	$V_{OL1}$	$R_L=20k\Omega$	-	0.05	0.1	V
Maximum Output Voltage 2	$V_{OH2}$	$R_L=2k\Omega$	2.75	2.85	-	V
	$V_{OL2}$	$R_L=2k\Omega$	-	0.15	0.25	V
Input Common Mode Voltage Range	$V_{ICM}$	CMR $\geq$ 48dB	0	-	3	V

(Note3) CMR is represented by either CMR+ or CMR-has lower value.

CMR+ is measured with  $1.5V \leq V_{CM} \leq 3.0$  and CMR- is measured with  $0V \leq V_{CM} \leq 1.5V$ .

### ●AC CHARACTERISTICS

( $V^+=3V, T_a=25^\circ C$ )

PARAMETER	SYMBOL	TEST CONDITION	MIN.	TYP.	MAX.	UNIT
Unity Gain Bandwidth	GB	$R_L=2k\Omega$	-	1	-	MHz
Phase Margin	$\Phi_M$	$R_L=2k\Omega$	-	75	-	Deg
Equivalent Input Noise Voltage	$V_{NI}$	$f=1kHz$	-	10	-	$nV/\sqrt{Hz}$

### ●TRANSIENT CHARACTERISTICS

( $V^+=3V, T_a=25^\circ C$ )

PARAMETER	SYMBOL	TEST CONDITION	MIN.	TYP.	MAX.	UNIT
Slew Rate	SR	$R_L=2k\Omega$	-	0.35	-	V/ $\mu s$

## ■ ELECTRICAL CHARACTERISTICS ( $V^+=1.8V, T_a=25^\circ C$ )

### ●DC CHARACTERISTICS

( $V^+=1.8V, T_a=25^\circ C$ )

PARAMETER	SYMBOL	TEST CONDITION	MIN.	TYP.	MAX.	UNIT
Operating Current	$I_{CC}$	No signal applied	-	460	800	$\mu A$
Input Offset Voltage	$V_{IO}$		-	1	5	mV
Input Bias Current	$I_B$		-	50	250	nA
Input Offset Current	$I_{IO}$		-	5	100	nA
Large Signal Voltage Gain	$A_V$	$R_L=2k\Omega$	60	83	-	dB
Common Mode Rejection Ratio	CMR	CMR+: $0.9V \leq V_{CM} \leq 1.8V$ CMR-: $0V \leq V_{CM} \leq 0.9V$ (Note4)	48	55	-	dB
Supply Voltage Rejection Ratio	SVR	$V^+V^-=\pm 1.2V \sim \pm 2.0V$	65	80	-	dB
Maximum Output Voltage 1	$V_{OH1}$	$R_L=20k\Omega$	1.7	1.75	-	V
	$V_{OL1}$	$R_L=20k\Omega$	-	0.05	0.1	V
Maximum Output Voltage 2	$V_{OH2}$	$R_L=2k\Omega$	1.55	1.65	-	V
	$V_{OL2}$	$R_L=2k\Omega$	-	0.15	0.25	V
Input Common Mode Voltage Range	$V_{ICM}$	CMR $\geq$ 40dB	0	-	1.8	V

(Note4) CMR is represented by either CMR+ or CMR-has lower value.

CMR+ is measured with  $0.9V \leq V_{CM} \leq 1.8$  and CMR- is measured with  $0V \leq V_{CM} \leq 0.9V$ .

### ●AC CHARACTERISTICS

( $V^+=1.8V, T_a=25^\circ C$ )

PARAMETER	SYMBOL	TEST CONDITION	MIN.	TYP.	MAX.	UNIT
Unity Gain Bandwidth	GB	$R_L=2k\Omega$	-	1	-	MHz
Phase Margin	$\Phi_M$	$R_L=2k\Omega$	-	75	-	Deg
Equivalent Input Noise Voltage	$V_{NI}$	$f=1kHz$	-	10	-	$nV/\sqrt{Hz}$

### ●TRANSIENT CHARACTERISTICS

( $V^+=1.8V, T_a=25^\circ C$ )

PARAMETER	SYMBOL	TEST CONDITION	MIN.	TYP.	MAX.	UNIT
Slew Rate	SR	$R_L=2k\Omega$	-	0.3	-	V/ $\mu s$

## ■ TYPICAL CHARACTERISTICS

Operating Current vs Operating Voltage

$G_V=0\text{dB}$ ,  $T_a=25^\circ\text{C}$

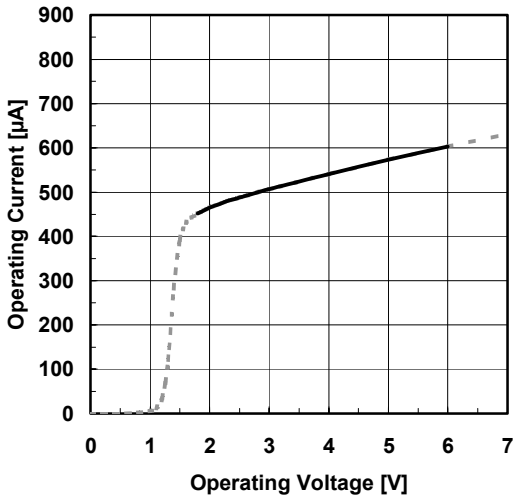

Operating Current vs. Operating Voltage (correlation with  $T_a$ )

$G_V=0\text{dB}$ ,  $T_a=25^\circ\text{C}$

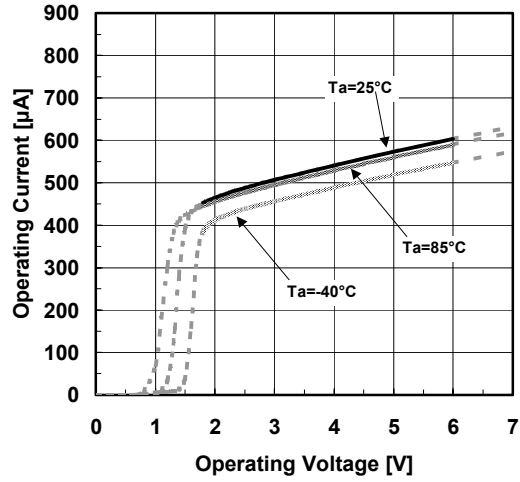

Operating Current vs. Ambient Temperature

$G_V=0\text{dB}$

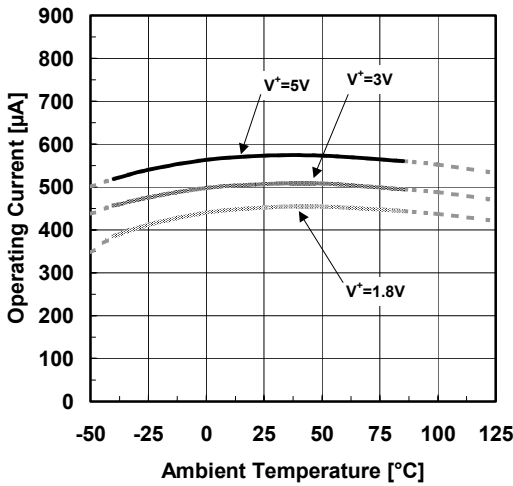

Input Offset Voltage vs. Ambient Temperature

$G_V=0\text{dB}$

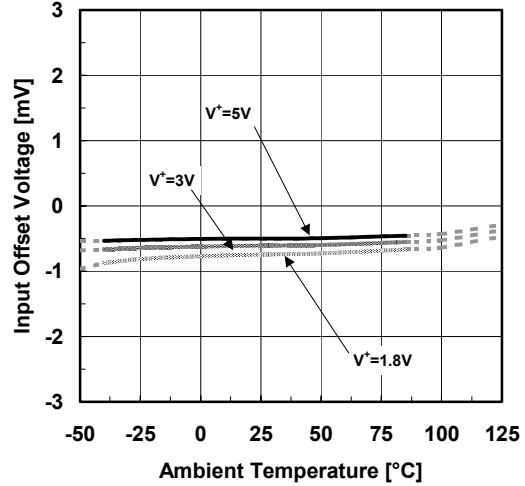

Input Bias Current vs. Ambient Temperature

$G_V=0\text{dB}$

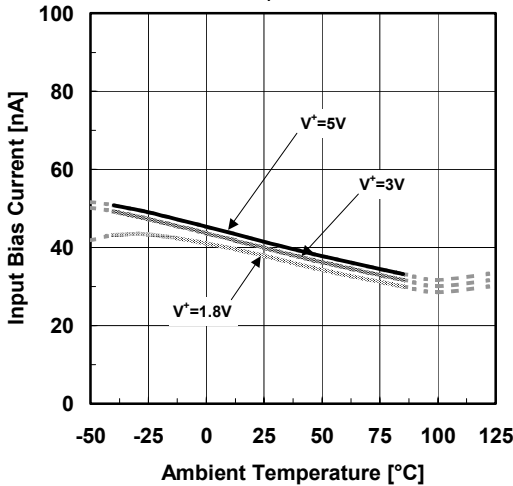

Input Offset Current vs. Ambient Temperature

$G_V=0\text{dB}$

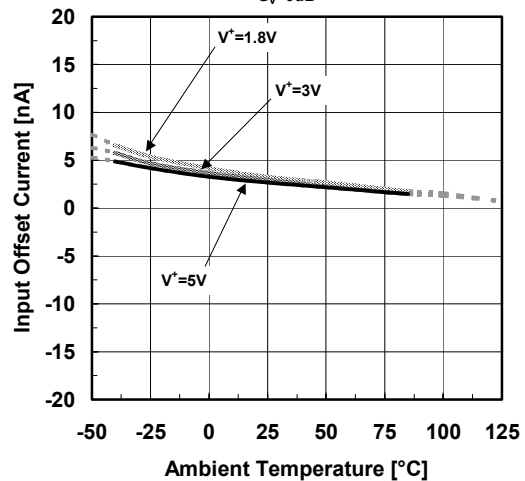

## ■ TYPICAL CHARACTERISTICS

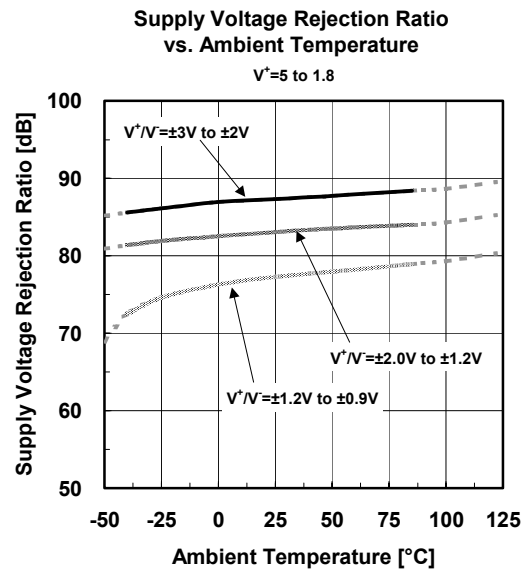
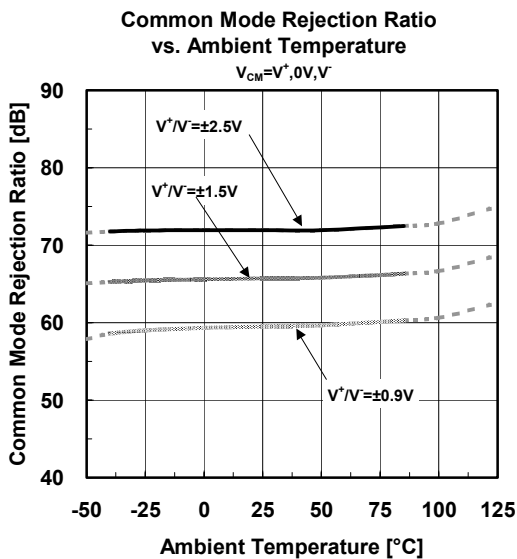
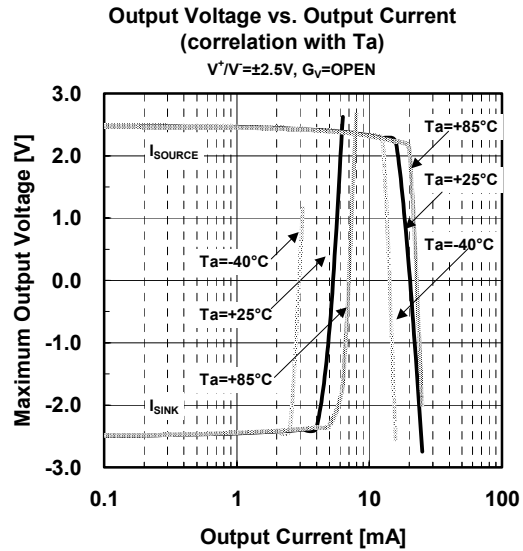
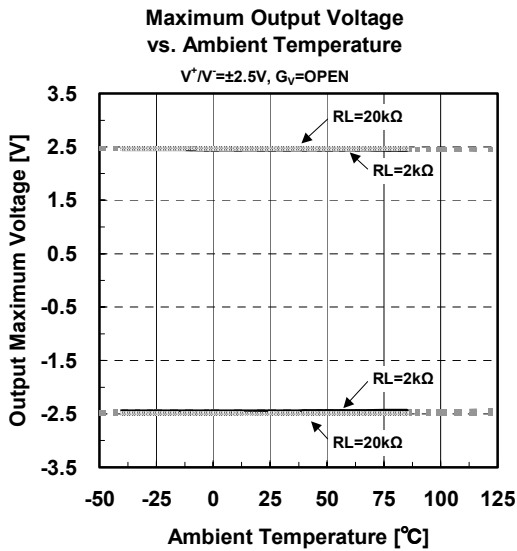
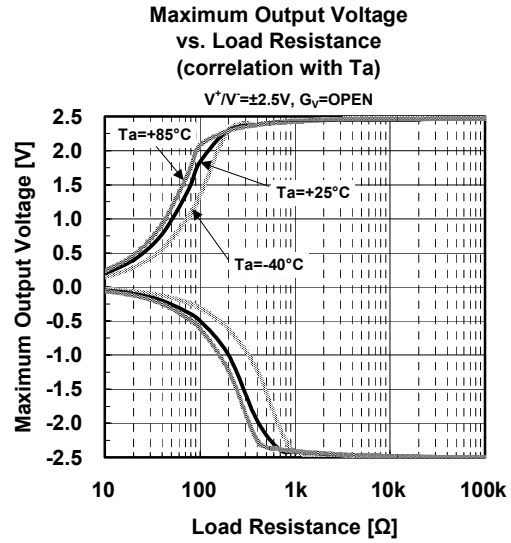
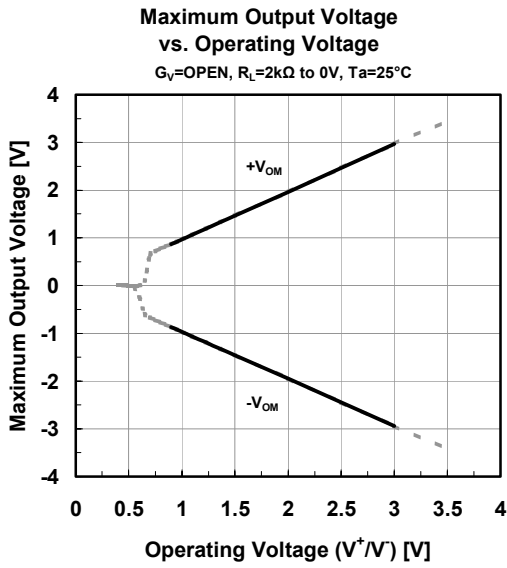

## ■ TYPICAL CHARACTERISTICS

Voltage Gain/Phase vs. Frequency  
(with Capacitive load)

$V^+ / V^- = \pm 2.5V$ ,  $G_V = 40dB$ ,  $R_F = 2k\Omega$ ,  
 $R_G = 20\Omega$ ,  $R_L = 2k\Omega$ ,  $T_a = +25^\circ C$

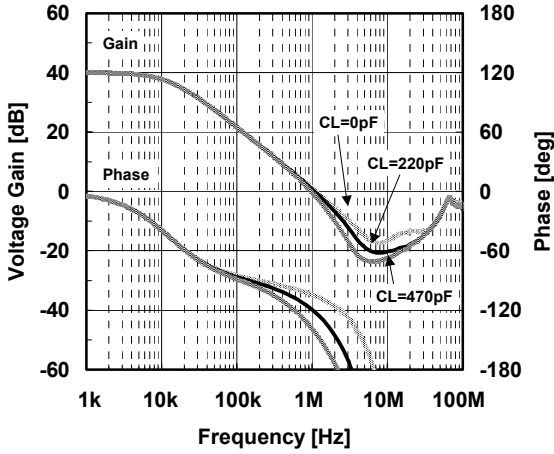

Voltage Gain/Phase vs. Frequency  
(correlation with  $T_a$ )

$V^+ / V^- = \pm 2.5V$ ,  $G_V = 40dB$ ,  
 $R_F = 2k\Omega$ ,  $R_G = 20\Omega$ ,  $R_L = 2k\Omega$ ,  $C_L = 0pF$

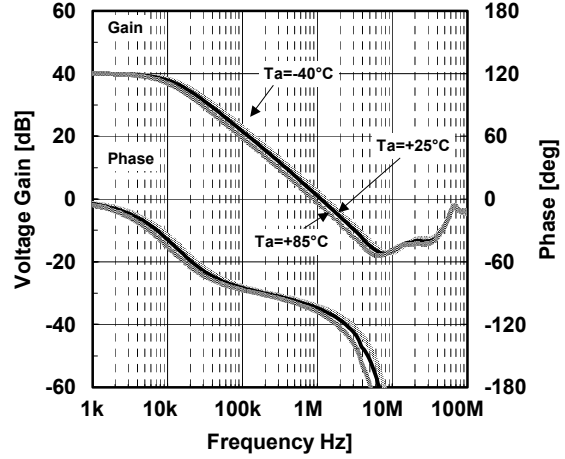

Phase Margin vs. Load Capacitance  
(with Capacitance Load)

$V^+ / V^- = \pm 1.5V$ ,  $G_V = 40dB$ ,  $R_F = 2k\Omega$ ,  
 $R_G = 20\Omega$ ,  $R_L = 2k\Omega$ ,  $T_a = +25^\circ C$

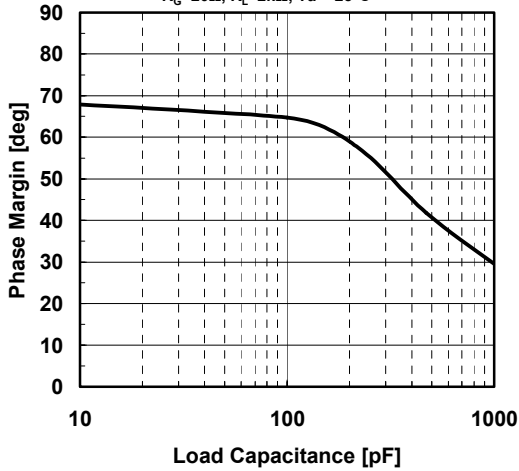

Voltage Gain vs. Frequency  
(correlation with  $T_a$ )

$V^+ / V^- = \pm 2.5V$ ,  $G_V = 0dB$ ,  $C_L = 100pF$ ,  
 $R_S = 50\Omega$ ,  $R_L = 2k\Omega$

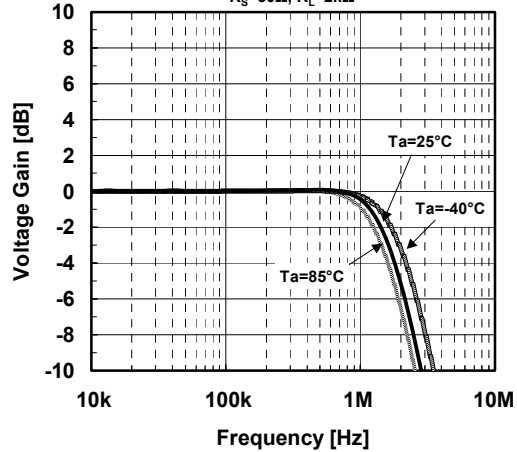

Voltage Gain vs. Frequency  
(with Capacitance Load)

$V^+ / V^- = \pm 2.5V$ ,  $G_V = 0dB$ ,  
 $R_S = 50\Omega$ ,  $R_L = 2k\Omega$ ,  $T_a = +25^\circ C$

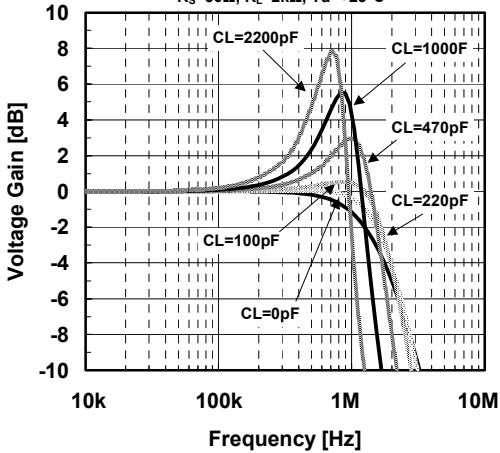

Voltage Gain vs. Frequency  
(correlation with  $T_a$ )

$V^+ / V^- = \pm 2.5V$ ,  $G_V = 0dB$ ,  $C_L = 1000pF$ ,  
 $R_S = 50\Omega$ ,  $R_L = 2k\Omega$

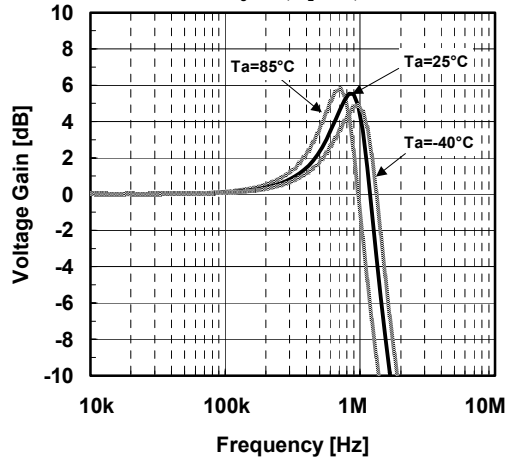

## ■ TYPICAL CHARACTERISTICS

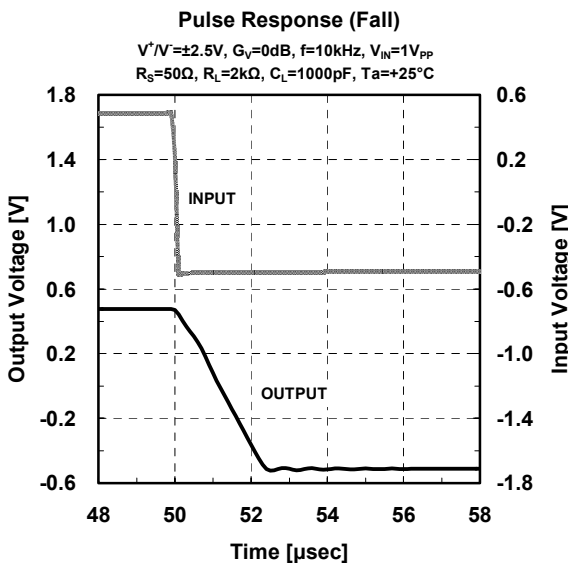
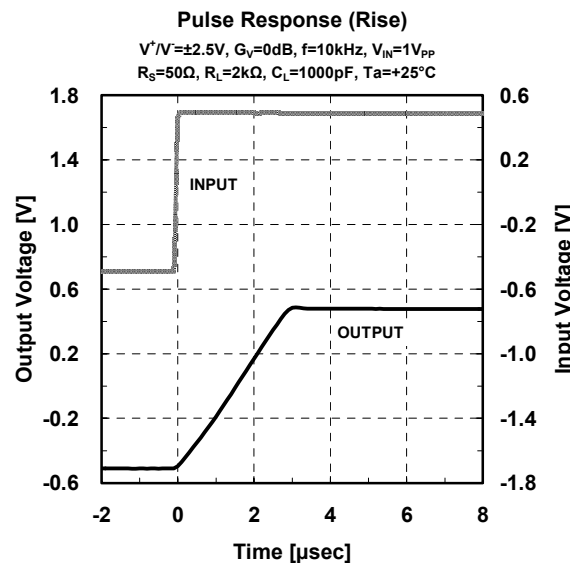
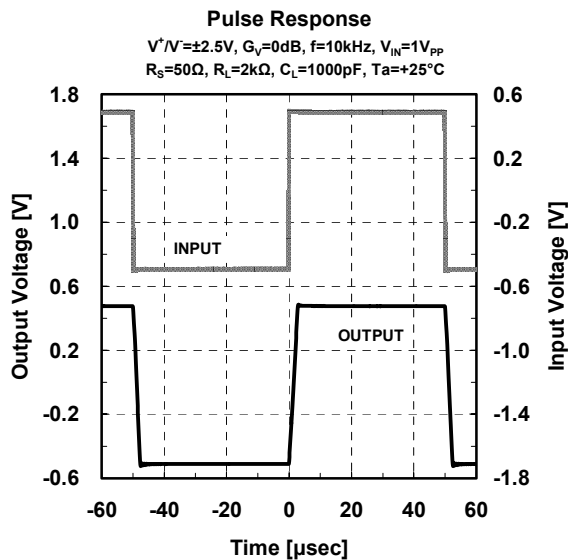
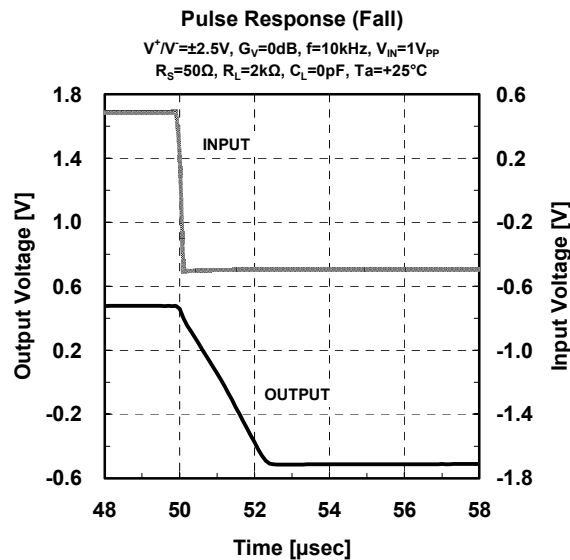
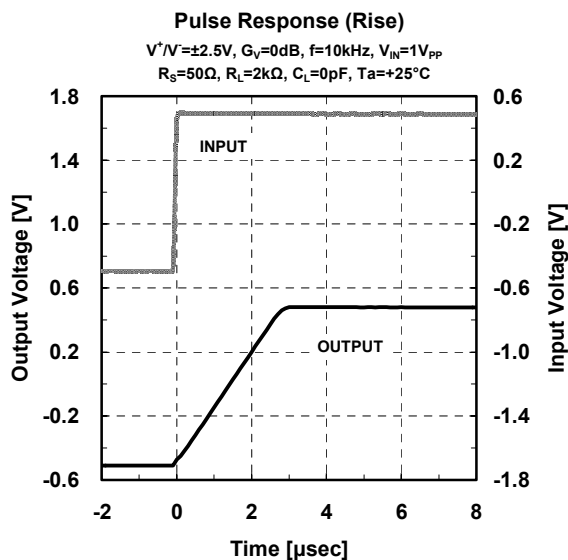
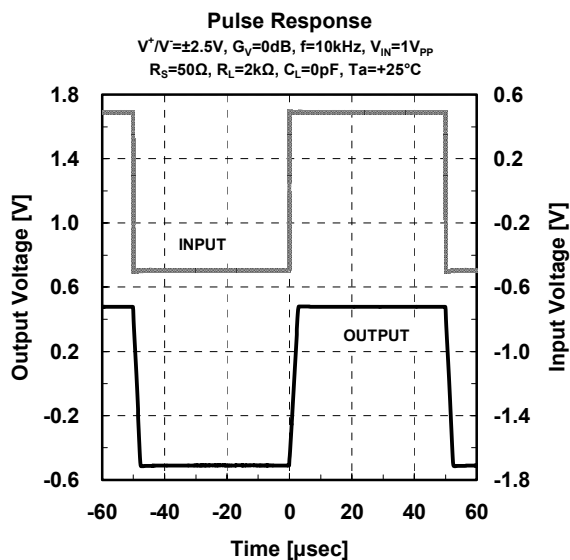

## ■ TYPICAL CHARACTERISTICS

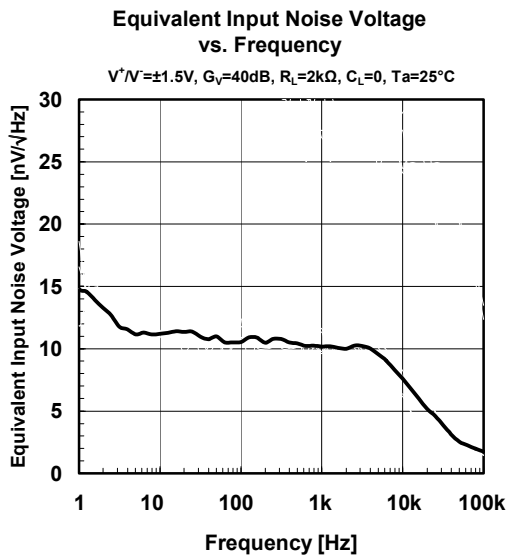
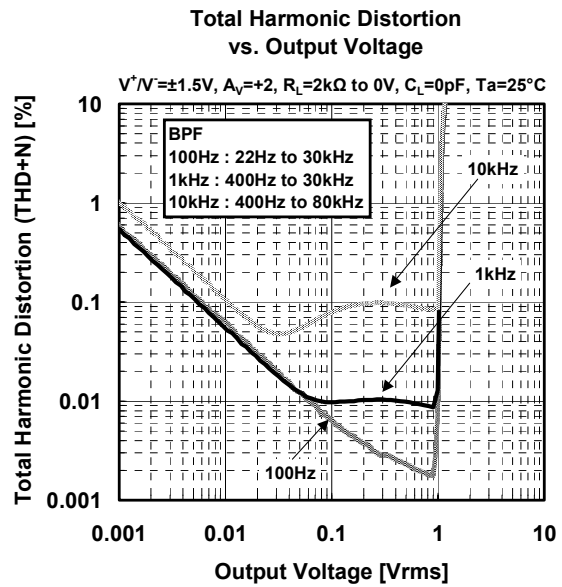
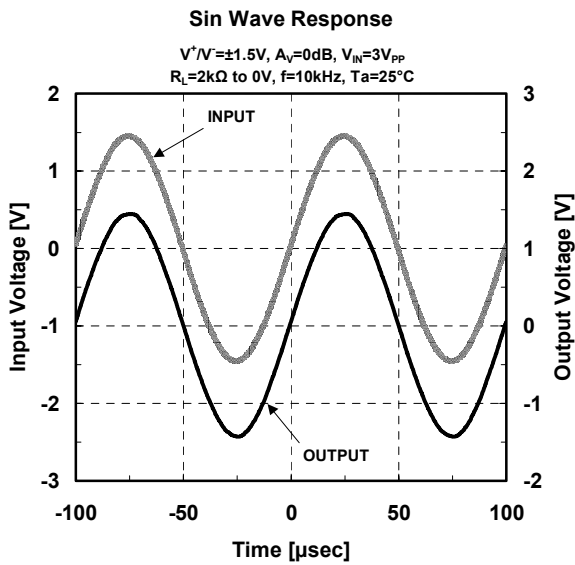



**[CAUTION]**

The specifications on this databook are only given for information, without any guarantee as regards either mistakes or omissions. The application circuits in this databook are described only to show representative usages of the product and not intended for the guarantee or permission of any right including the industrial rights.

## Looking for pricing, stock, or lifecycle information?

Click below to explore more details on WIN SOURCE:

-  [View NJM2732V on WIN SOURCE](#)
-  [NJR Corporation/NJRC Information](#)

## Optimize Your Supply Chain with WIN SOURCE Solutions

-  Global Sourcing Solution
-  Obsolete Management
-  Cost Control Management
-  Shortage Management
-  Alternative Solution
-  Excess Inventory Management