

## Ground Noise Isolation Amplifier

### ■ GENERAL DESCRIPTION

The **NJM2794** is a ground noise isolation amplifier designed for car audio system. It contains dual channel differential amplifier.

It is developed for those car audio applications where long connections between head unit and other components are necessary and ground noise has to be eliminated.

### ■ PACKAGE OUTLINE



**NJM2794RB2**  
MSOP10 (TVSP10)

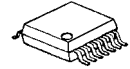

**NJM2794V**  
(SSOP14)

### ■ FEATURES

- Dual Channel Differential Amplifier
- Operating Voltage 4.3 to 13V
- Operating Current 14mA typ.
- Common mode rejection ratio CMRR=60dB typ.
- Maximum Output Voltage 2Vrms min., @ THD=0.1%
- Supply Voltage Rejection Ratio 60dB typ.
- Total Harmonic Distortion 0.002% typ.
- Noise Output Voltage 1.3μVrms typ.
- Bipolar Technology
- Package Outline MSOP10 (TVSP10)\*  
SSOP14  
\*MEET JEDEC MO-187-DA / THIN TYPE

### ■ BLOCK DIAGRAM

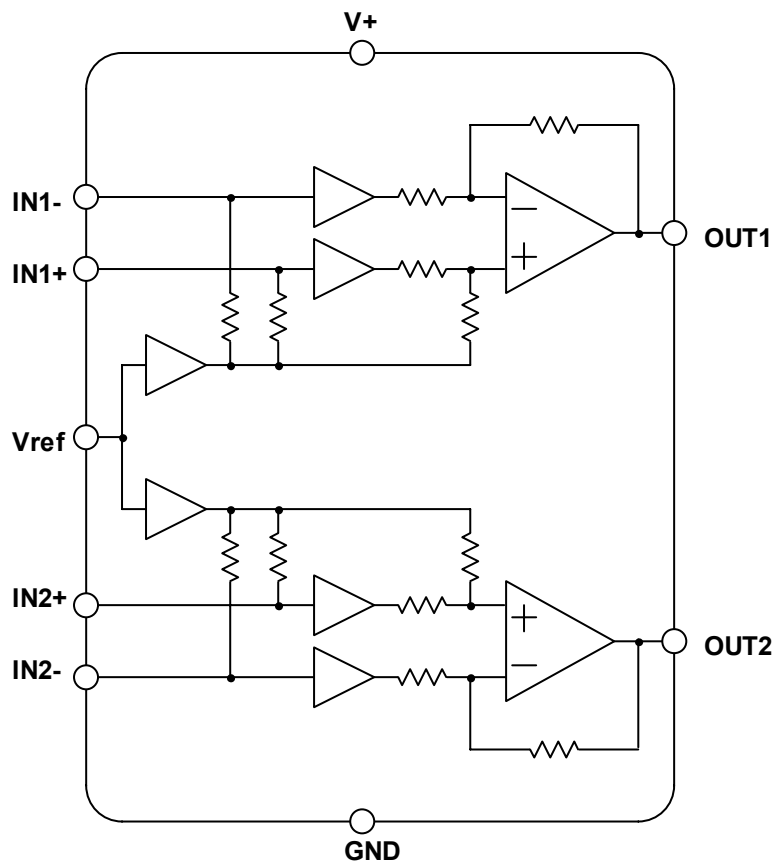

# NJM2794

## ■ PIN CONFIGURATION

### MSOP10(TVSP10)

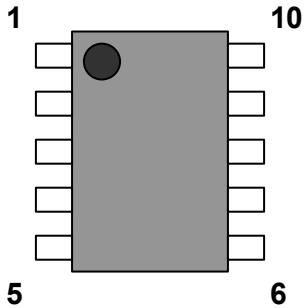

No.	Symbol	Function
1	OUT1	Output1
2	GND	Ground
3	Vref	Reference Voltage
4	V+	Power Supply
5	OUT2	Output2
6	IN2+	+Input2
7	IN2-	-Input2
8	NC	No Connect
9	IN1-	-Input1
10	IN1+	+Input1

### SSOP14

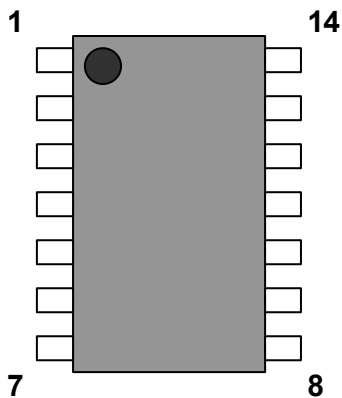

No.	Symbol	Function
1	OUT1	Output1
2	NC	No Connect
3	GND	Ground
4	Vref	Reference Voltage
5	V+	Power Supply
6	NC	No Connect
7	OUT2	Output2
8	IN2+	+Input2
9	NC	No Connect
10	IN2-	-Input2
11	NC	No Connect
12	IN1-	-Input1
13	NC	No Connect
14	IN1+	+Input1

## ■ ABSOLUTE MAXIMUM RANGES (Ta=25°C)

PARAMETER	SYMBOL	RANGE	UNIT
Supply Voltage	V <sup>+</sup>	+15	V
Maximum Input Voltage	V <sub>IM</sub>	0 to V <sup>+</sup> (*)	V
Power Dissipation	P <sub>D</sub>	MSOP10(TVSP10) : 530* SSOP14 : 550* <small>NOTE: EIA/JEDEC STANDARD Test board (76.2x114.3x1.6mm, 2layer, FR-4) mounting</small>	mW
Operating Temperature	Topr	-40 to +85	°C
Storage Temperature	Tstg	-40 to +150	°C

(\*) For the maximum input voltage less than 0 toV<sup>+</sup>

## ■ ELECTRICAL CHARACTERISTIC (V<sup>+</sup>=9V, Ta=25°C)

PARAMETER	SYMBOL	TEST CONDITION	MIN.	TYP.	MAX.	UNIT
<b>DC CHARACTERISTIC</b>						
Operating Voltage	V <sup>+</sup>		4.3	9	13	V
Operating Current	I <sub>CC</sub>	No Signal	-	14	20	mA
Reference Voltage	V <sub>REF</sub>		3.8	4.3	4.8	V
<b>AC CHARACTERISTIC (Non-inverting circuit, f=1kHz, V<sub>in</sub>=1V<sub>rms</sub>, R<sub>g</sub>=0Ω, R<sub>L</sub>=10kΩ unless otherwise specified)</b>						
Voltage Gain	G <sub>v</sub>		-1.0	0.0	+1.0	dB
Channel Separation	CS	f=1kHz	90	110	-	dB
Channel Balance	BAL		-	-	0.5	dB
Roll-off High Frequency	f <sub>RH</sub>	-1dB	100	-	-	kHz
Input Resistance	R <sub>IN</sub>		85	105	125	kΩ
Output Resistance	R <sub>OUT</sub>		-	90	-	Ω
Maximum Output Voltage 1	V <sub>OM1</sub>	THD=0.1%, f = 1kHz	2	2.5	-	V <sub>rms</sub>
Maximum Output Voltage 2	V <sub>OM2</sub>	THD=0.1%, f = 1kHz, V <sup>+</sup> =8V	1.7	2.1	-	V <sub>rms</sub>
Maximum Output Voltage 3	V <sub>OM3</sub>	Inverting, THD=0.1%, f = 1kHz	-	2.5	-	V <sub>rms</sub>
Maximum Output Voltage 4	V <sub>OM4</sub>	Inverting, THD=0.1%, f = 1kHz, V <sup>+</sup> =8V	-	2.1	-	V <sub>rms</sub>
Noise Output Voltage	V <sub>NO</sub>	R <sub>g</sub> =600Ω, A-weighted	-	1.3	2.5	μV <sub>rms</sub>
Total Harmonic Distortion	THD	f=1kHz, V <sub>O</sub> =1V <sub>rms</sub> , BW=400Hz to 30kHz	-	0.002	0.01	%
Common Mode Rejection Ratio	CMRR		50	60	-	dB
Common Mode Input Voltage	V <sub>icm</sub>	CMRR=50dB	-	2	-	V <sub>rms</sub>
Supply Voltage Rejection Ratio	SVR	f=100Hz, V <sub>ripple</sub> =100mV <sub>rms</sub>	55	65	-	dB

# NJM2794

## ■ TERMINAL DESCRIPTION

PIN NO.		SYMBOL	FUNCTION	EQUIVALENT CIRCUIT	TERMINAL DC VOLTAGE
TVSP 10	SSOP 14				
1 5	1 7	OUT1 OUT2	Output1 Output2		$V^+ \times 0.48$ [V]
6 7 9 10	8 10 12 14	IN2+ IN2- IN1- IN1+	+Input2 -Input2 -Input1 +Input1		$V^+ \times 0.48$ [V]
3	4	Vref	Reference Voltage		$V^+ \times 0.48$ [V]

## ■ APPLICATION CIRCUIT

### ● MSOP10(TVSP10) : NJM2794RB2

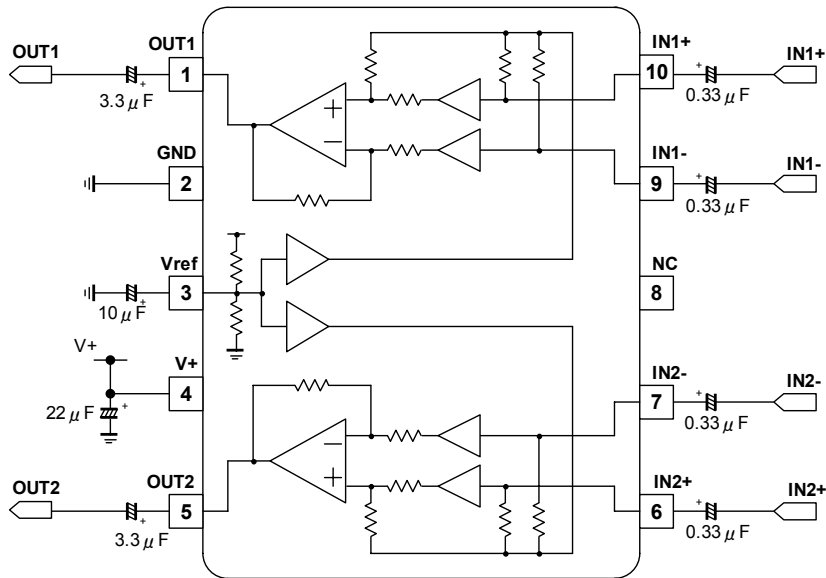

### ● SSOP14 : NJM2794V

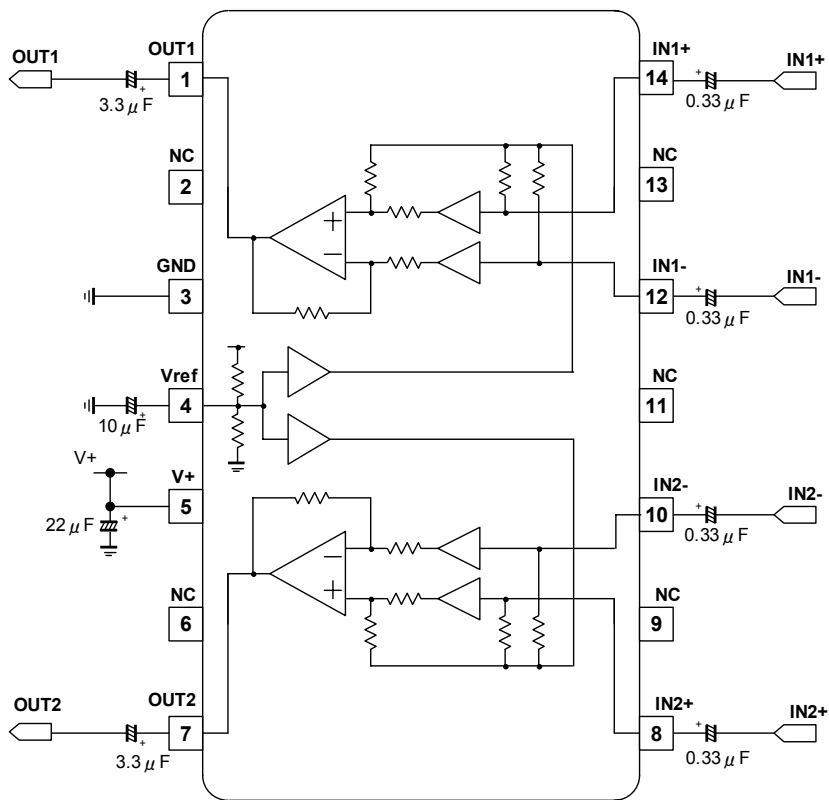

# NJM2794

## ■ APPLICATION BLOCK DIAGRAM

(1) Non-inverting line input

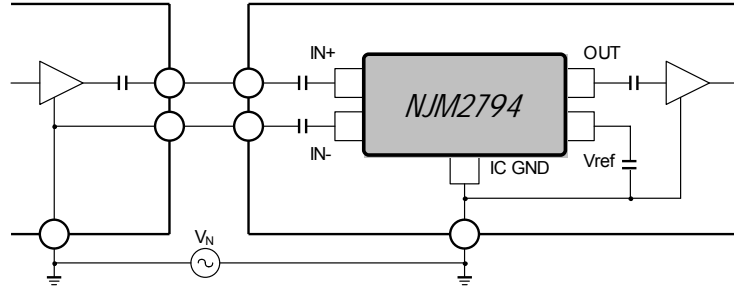

(2) Inverting line input

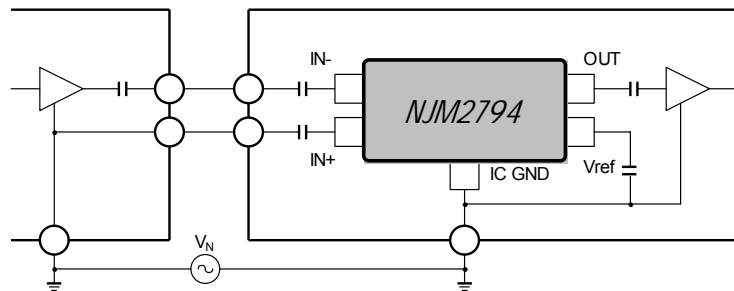

(3) Non-inverting line output

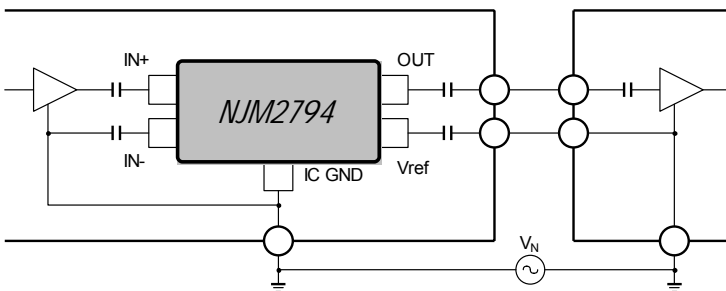

(4) Inverting line output

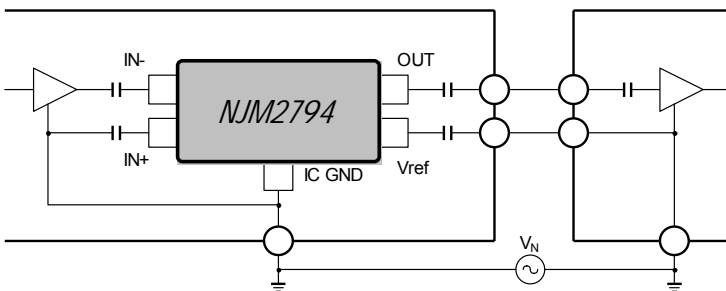

## ■ TYPICAL CHARACTERISTICS

Operating Current vs. Ambient Temperature  
V+=9V

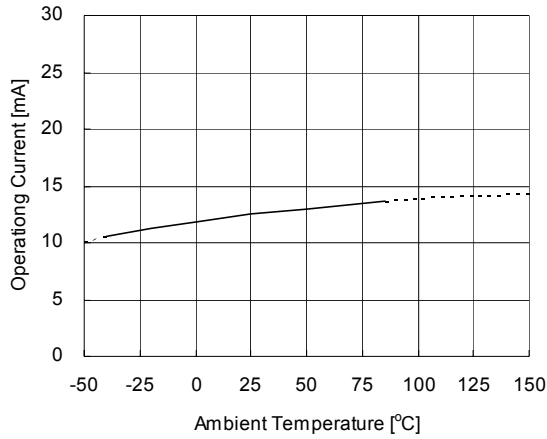

Operating Current vs. Operating Voltage

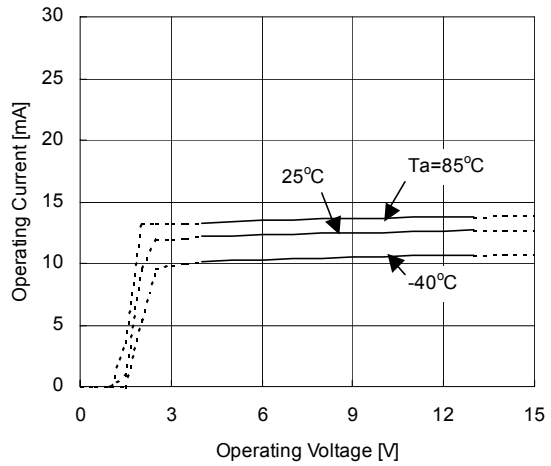

Reference Voltage vs. Ambient Temperature  
V+=9V

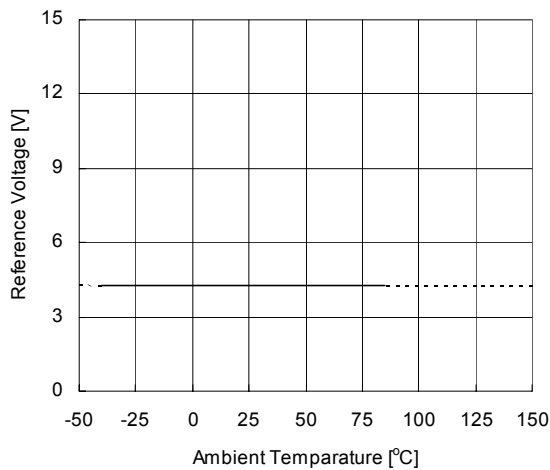

Reference Voltage vs. Operating Voltage

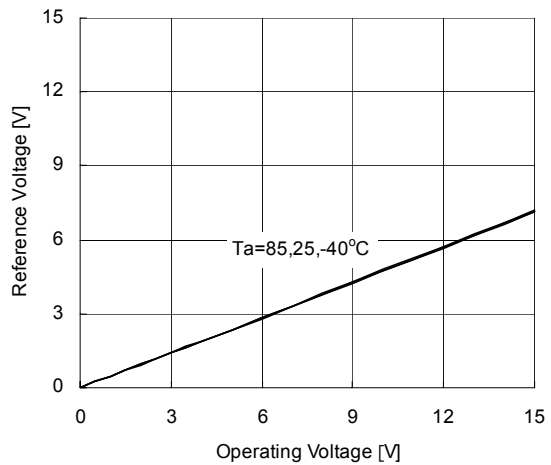

Noise Output Voltage vs. Ambient Temperature  
V+=9V, Rg=600Ω, A-Weighted

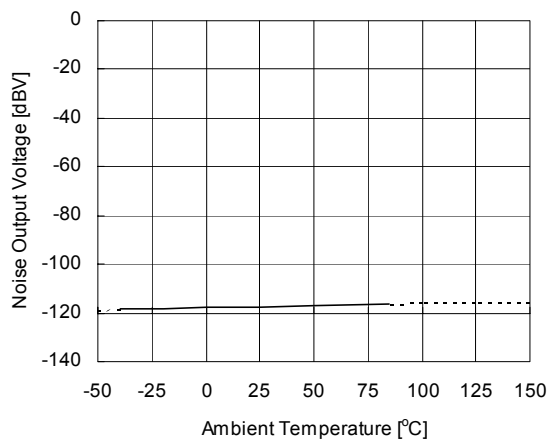

Noise Output Voltage vs. Signal Source Resistance  
V+=9V, Ta=25°C, A-Weighted

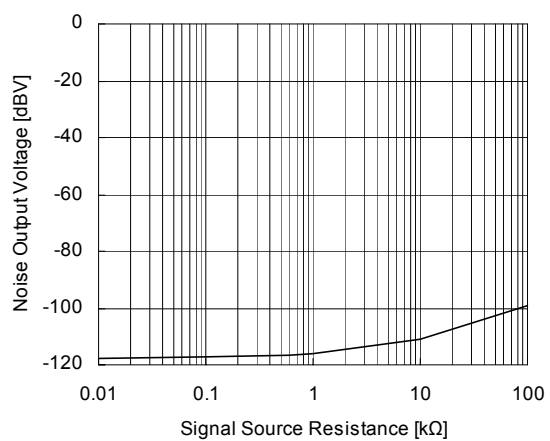

## ■ TYPICAL CHARACTERISTICS

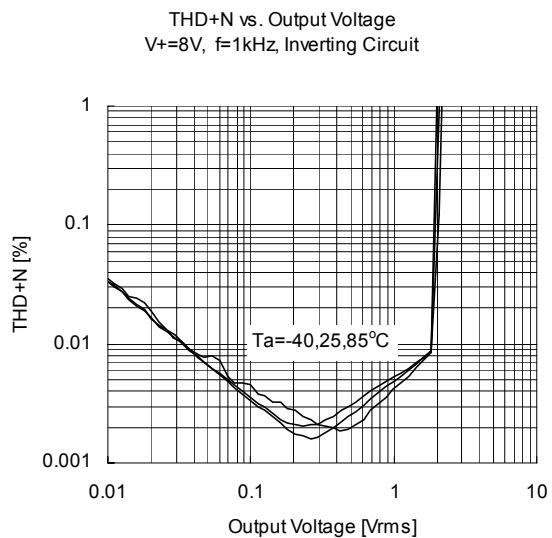
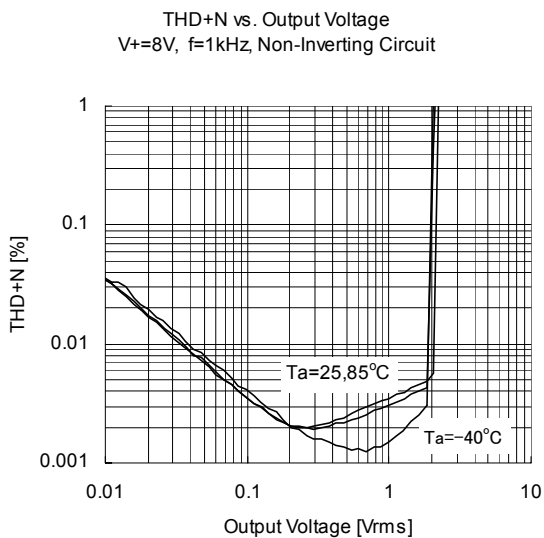
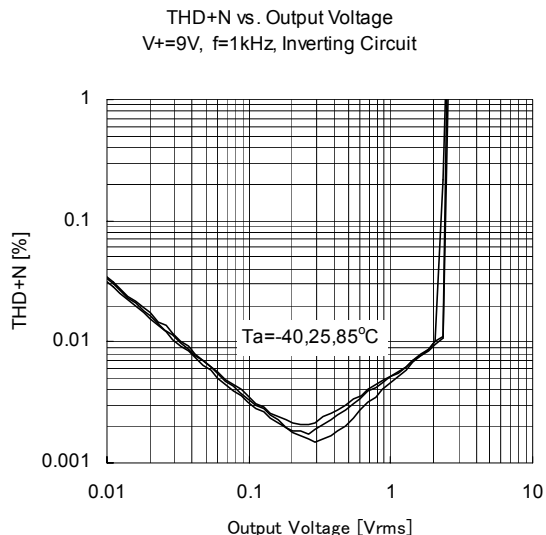
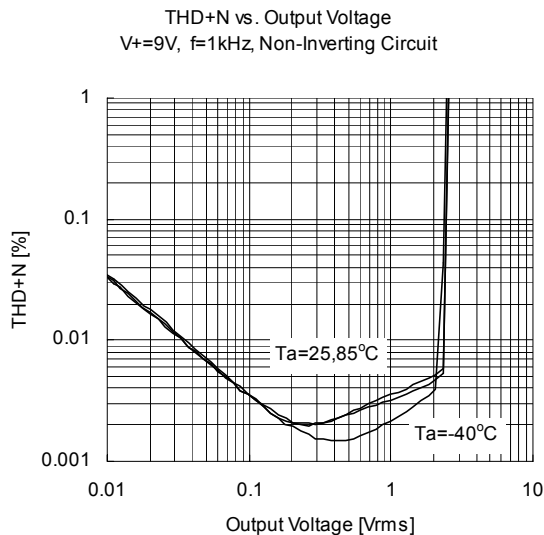
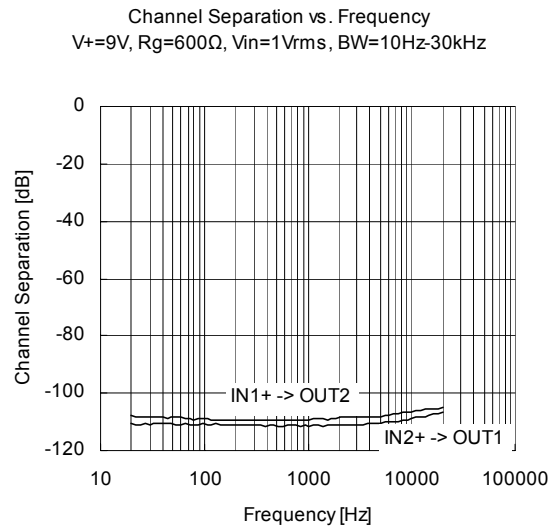
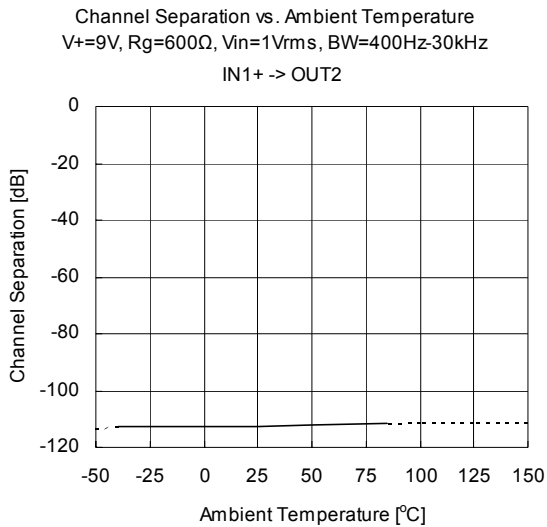

## ■ TYPICAL CHARACTERISTICS

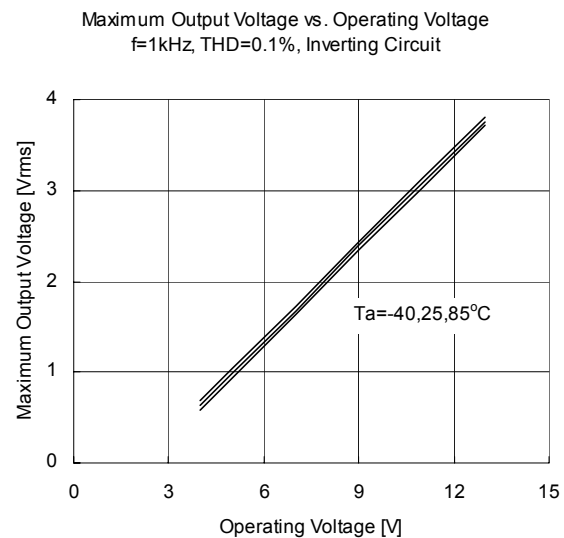
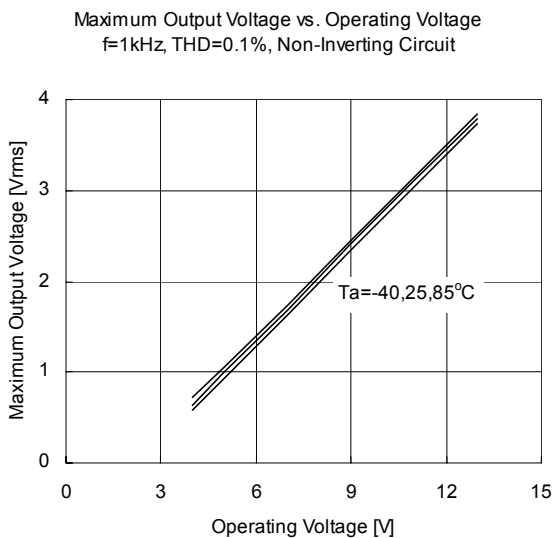
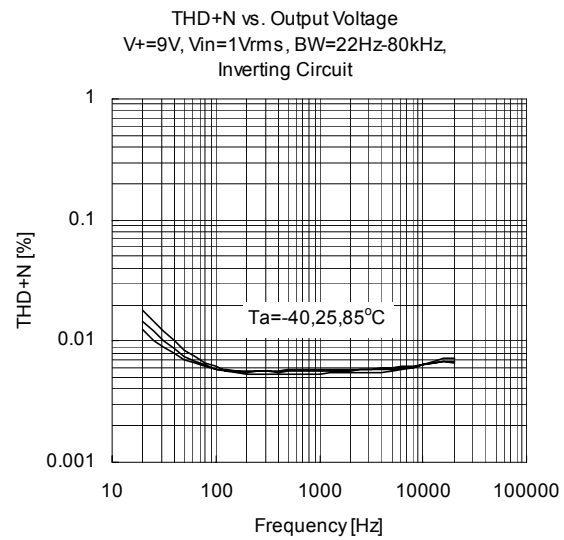
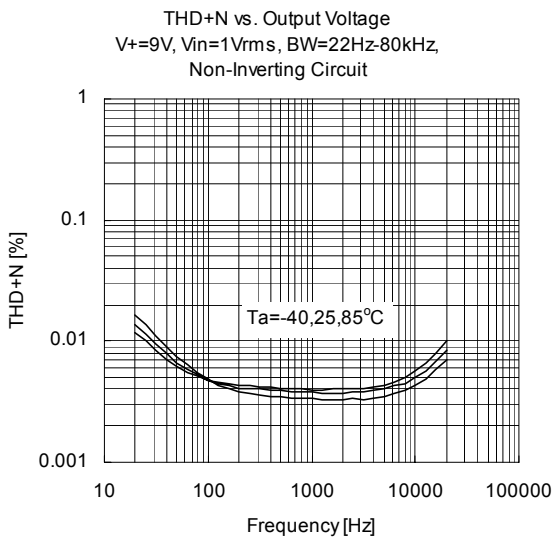
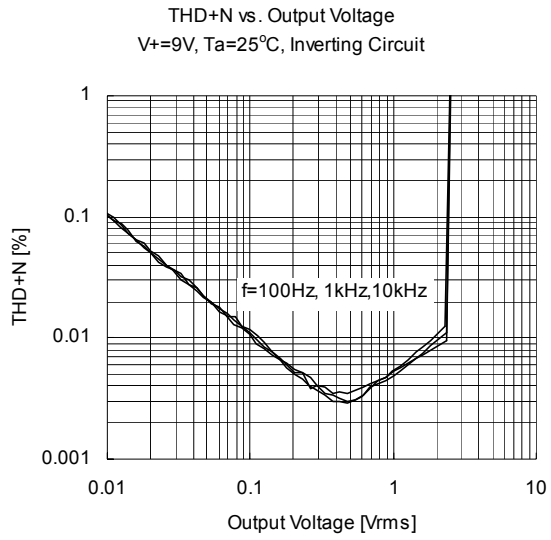
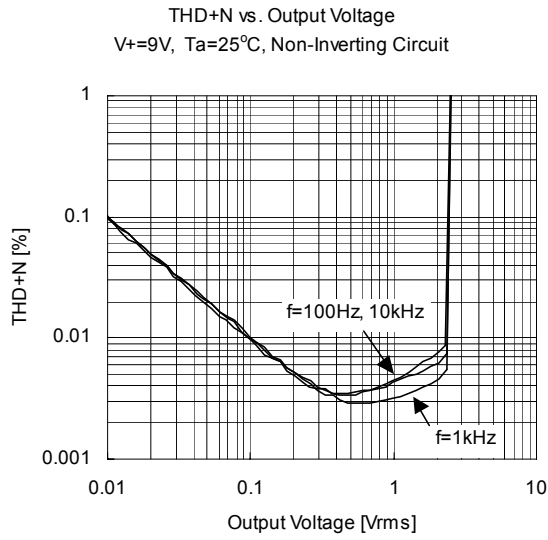

## ■ TYPICAL CHARACTERISTICS

Maximum Output Voltage vs. Load Resistance  
 $V_+ = 9V$ ,  $f = 1kHz$ ,  $T_a = 25^\circ C$ ,  $BW = 400 - 30kHz$   
 THD=0.1%

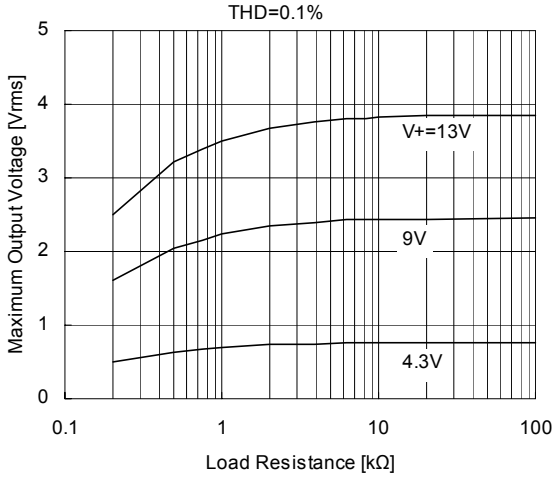

Voltage Gain vs. Frequency  
 $V_+ = 9V$ ,  $V_{in} = 1V_{rms}$ ,  $T_a = 25^\circ C$

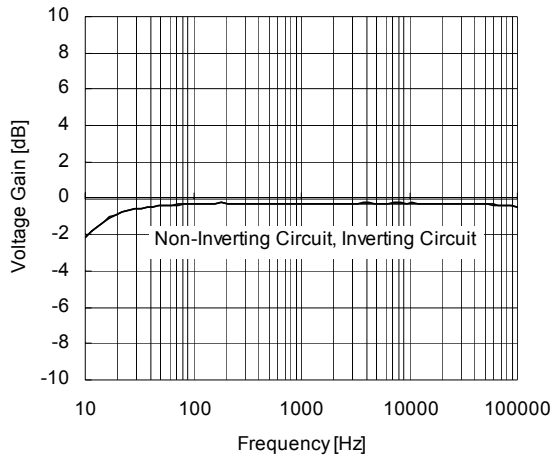

Reference Voltage Turn-on behaviour  
 $V_+ = 9V$ ,  $T_a = 25^\circ C$

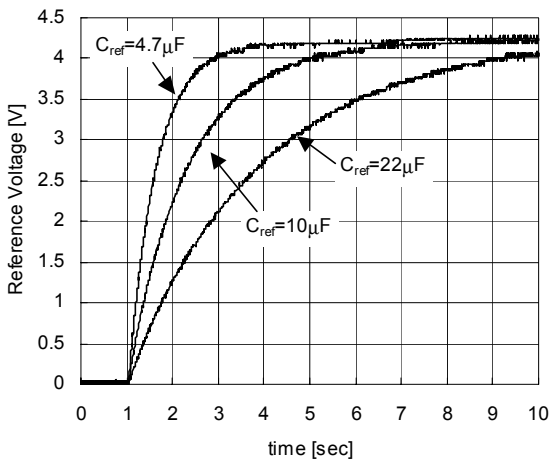

Supply Voltage Rejection Ratio vs. Frequency  
 $V_+ = 9V$ ,  $V_{ripple} = 100mV$ ,  $R_g = 600\Omega$ ,  $T_a = 25^\circ C$

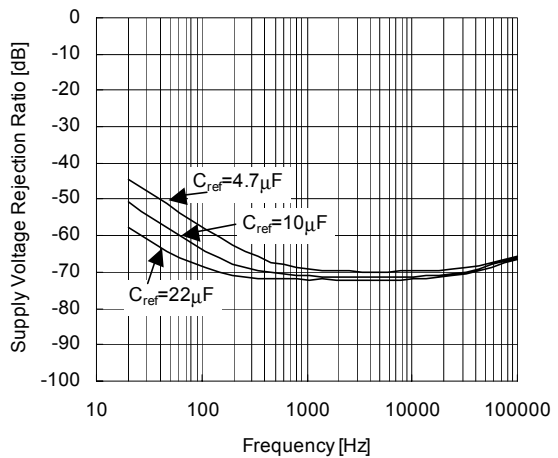

Supply Voltage Rejection Ratio vs. Signal Source Resistance  
 $V_+ = 9V$ ,  $V_{ripple} = 100mV$ ,  $f = 100Hz$ ,  $T_a = 25^\circ C$

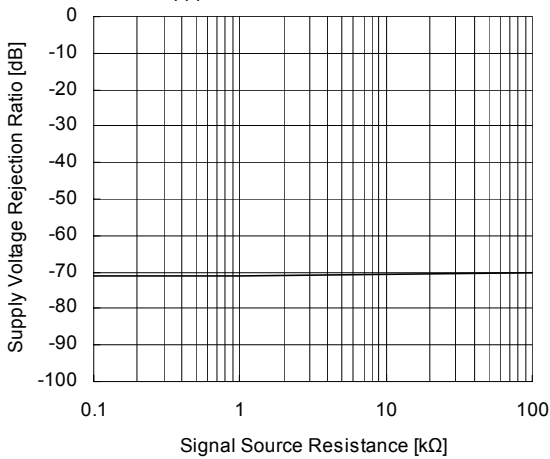

Supply Voltage Rejection Ratio vs. Operating Voltage  
 $V_{ripple} = 100mV$ ,  $f = 100Hz$ ,  $R_g = 600\Omega$ ,  $T_a = 25^\circ C$

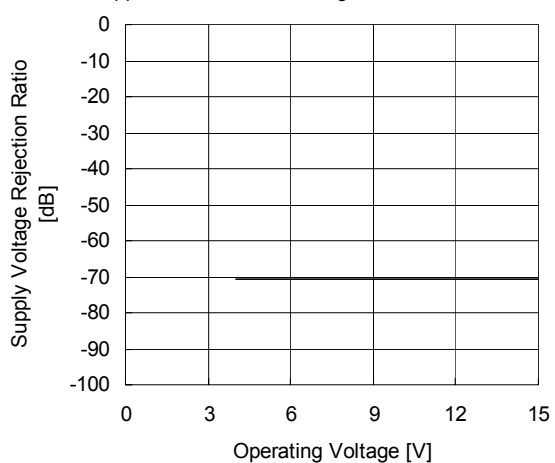

## ■ TYPICAL CHARACTERISTICS

Common Mode Rejection Ratio vs. Frequency  
 $V_+ = 9V, V_{in} = 1V_{rms}$

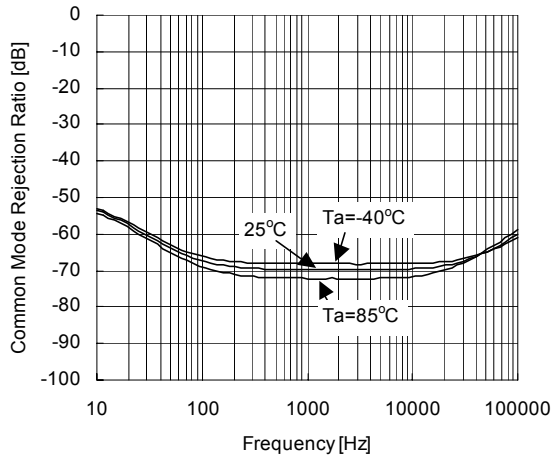

Common Mode Rejection Ratio vs. Input Voltage  
 $V_+ = 9V, f = 1kHz, T_a = 25^\circ C, BW = 400 - 30kHz$

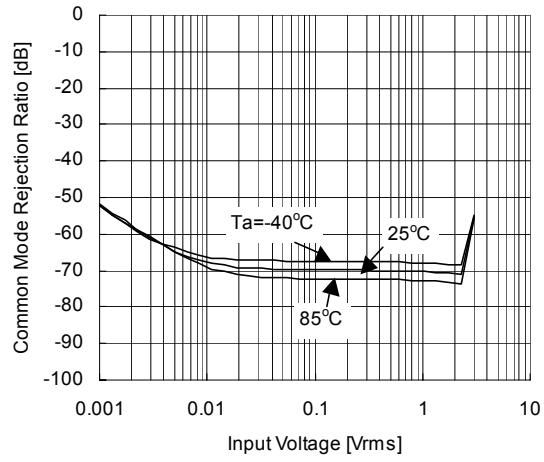

**[CAUTION]**

The specifications on this databook are only given for information, without any guarantee as regards either mistakes or omissions. The application circuits in this databook are described only to show representative usages of the product and not intended for the guarantee or permission of any right including the industrial rights.

## Looking for pricing, stock, or lifecycle information?

Click below to explore more details on WIN SOURCE:

- ⊖ [View NJM2794V-TE1 on WIN SOURCE](#)
- ⊖ [NJR Corporation/NJRC Information](#)

## Optimize Your Supply Chain with WIN SOURCE Solutions

- ✓ Global Sourcing Solution
- ✓ Obsolete Management
- ✓ Cost Control Management
- ✓ Shortage Management
- ✓ Alternative Solution
- ✓ Excess Inventory Management