

LOW DROPOUT VOLTAGE REGULATOR

■ GENERAL DESCRIPTION

The NJM2845/46 is low dropout voltage regulator. Advanced Bipolar technology achieves low noise, high ripple rejection and low quiescent current.

NJM2845 is 3 terminal type and NJM2846 is ON/OFF control built in type. These product can be selected according to the applications.

■ PACKAGE OUTLINE

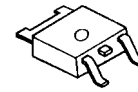

NJM2845DL1

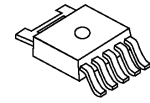

NJM2846DL3

■ FEATURES

- High Ripple Rejection 75dB typ. (f=1kHz,3V Version)
- Output Noise Voltage $V_{no}=45\mu V_{rms}$ typ. ($V_o=3V$ Version)
- Output capacitor with 2.2 μF ceramic capacitor ($V_o\geq 2.6V$)
- Output Current $I_o(max.)=800mA$
- High Precision Output $V_o \pm 1.0\%$
- Low Dropout Voltage 0.18V typ. ($I_o=500mA$)
- ON/OFF Control (NJM2846)
- Internal Short Circuit Current Limit
- Internal Thermal Overload Protection
- Bipolar Technology
- Package Outline TO-252-3 (NJM2845DL1), TO-252-5 (NJM2846DL3)

■ PIN CONFIGURATION

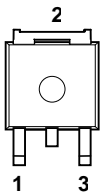

NJM2845DL1

1. V_{IN}
2. GND
3. V_{OUT}

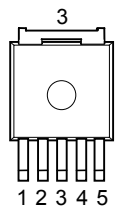

NJM2846DL3

1. CONTROL
2. V_{IN}
3. GND
4. V_o
5. NC

■ EQUIVALENT CIRCUIT

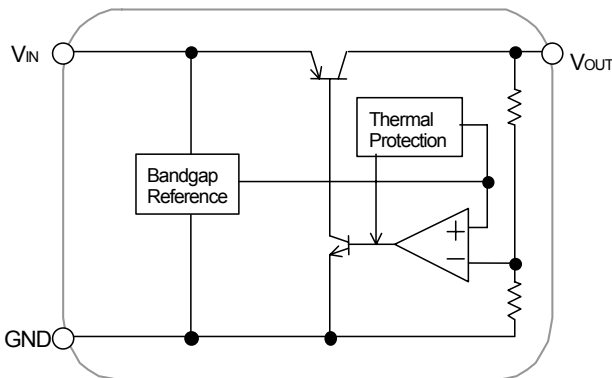

NJM2845DL1

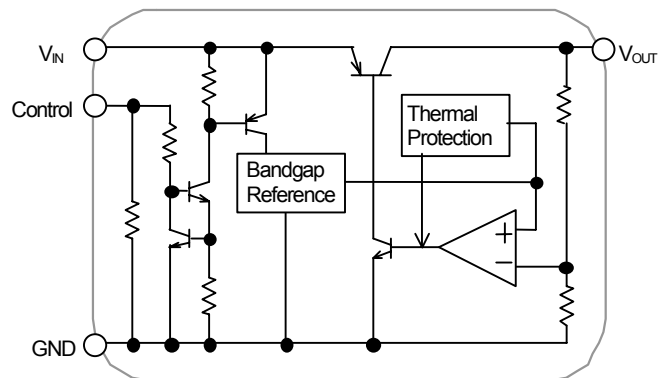

NJM2846DL3

NJM2845/46

■ OUTPUT VOLTAGE

Device Name	V _{OUT}
NJM284*DL*-15	1.5V
NJM284*DL*-18	1.8V
NJM284*DL*-02	2.0V
NJM284*DL*-22	2.2V
NJM284*DL*-23	2.3V
NJM284*DL*-25	2.5V
NJM284*DL*-03	3.0V
NJM284*DL*-33	3.3V
NJM284*DL*-04	4.0V
NJM284*DL*-05	5.0V

Output voltage options available : 1.5 ~ 5.0V (0.1V step)

■ ABSOLUTE MAXIMUM RATINGS (Ta=25°C)

PARAMETER	SYMBOL	RATINGS	UNIT
Input Voltage	V _{IN}	+14	V
Control Voltage	V _{CONT}	+14(*1)	V
Power Dissipation	P _D	10(Tc≤25°C) 1.0(Ta≤25°C)	W
Operating Temperature	Topr	-40 ~ +85	°C
Storage Temperature	Tstg	-40 ~ +150	°C

(*1): When input voltage is less than +14V, the absolute maximum control voltage is equal to the input voltage.

■ Operating voltage

$$V_{IN}=+2.5V(\text{In case of } V_o < 2.3V) \sim +(V_o+9V)$$

■ NJM2845

■ ELECTRICAL CHARACTERISTICS

(V_{IN}=V_o+1V, C_{IN}=0.33μF, C_o=2.2μF(1.7V<V_o≤2.6V:C_o=4.7μF, V_o≤1.7V: C_o=10μF), Ta=25°C)

PARAMETER	SYMBOL	TEST CONDITION	MIN.	TYP.	MAX.	UNIT
Output Voltage	V _o	I _o =30mA	-1.0%	-	+1.0%	V
Quiescent Current	I _Q	I _o =0mA	-	400	600	μA
Output Current	I _o	V _o - 0.3V	800	1050	-	mA
Line Regulation	ΔV _o /ΔV _{IN}	V _{IN} =V _o +1V ~ V _o +6V, I _o =30mA	-	-	0.10	%/V
Load Regulation	ΔV _o /ΔI _o	I _o =0 ~ 800mA	-	-	0.004	%/mA
Dropout Voltage(*2)	ΔV _{I-O}	I _o =500mA	-	0.18	0.28	V
Ripple Rejection	RR	e _{in} =200mVrms, f=1kHz, I _o =10mA, V _o =3V Version	-	75	-	dB
Average Temperature Coefficient of Output Voltage	ΔV _o /ΔTa	Ta=0 ~ 85°C, I _o =10mA	-	± 50	-	ppm/°C
Output Noise Voltage	V _{NO}	f=10Hz ~ 80kHz, I _o =10mA, V _o =3V Version	-	45	-	μVrms

(*2): The output voltage excludes under 2.3V.

The above specification is a common specification for all output voltages.

Therefore, it may be different from the individual specification for a specific output voltage.

POWER DISSIPATION vs. AMBIENT TEMPERATURE

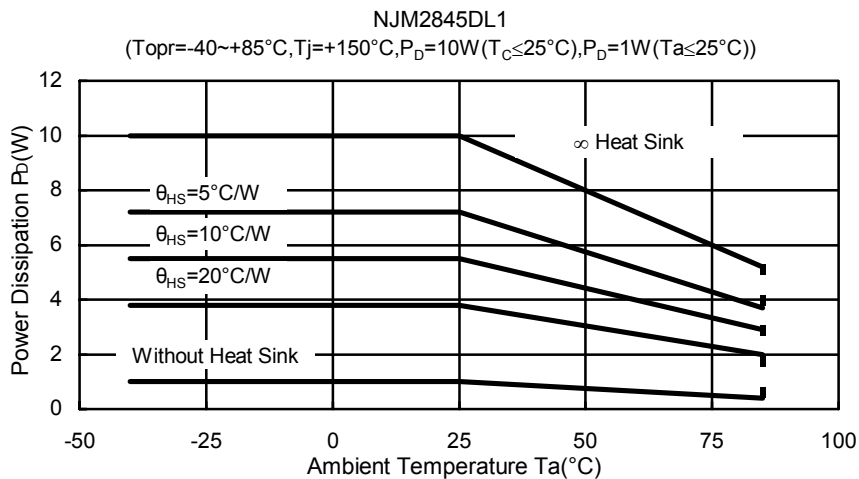

TEST CIRCUIT

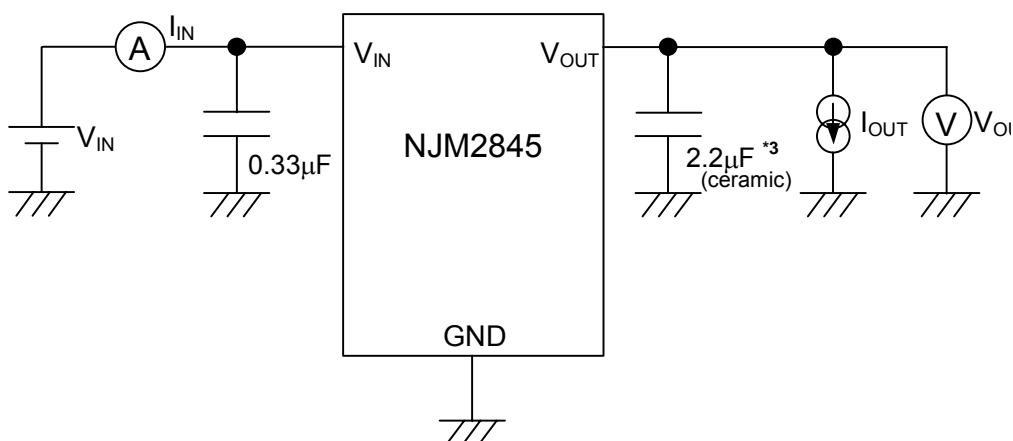

*3 1.7V < $V_o \leq 2.6\text{V}$ version: $C_o = 4.7\mu\text{F}$, $V_o \leq 1.7\text{V}$: $C_o = 10\mu\text{F}$ (ceramic)

TYPICAL APPLICATION

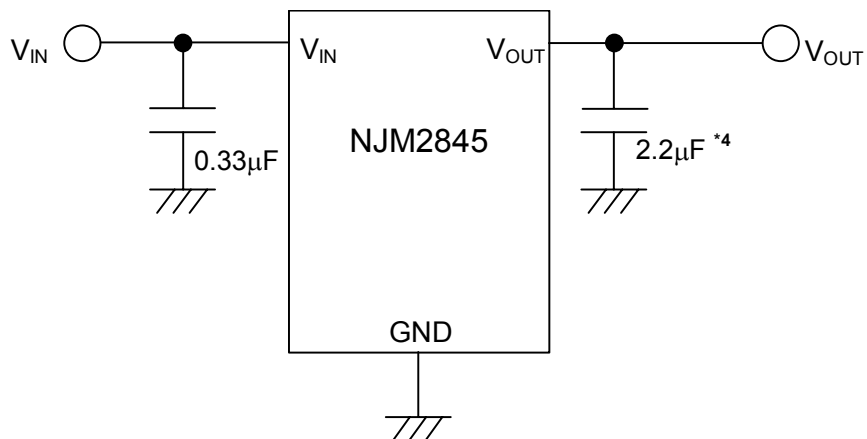

*4 1.7V < $V_o \leq 2.6\text{V}$ version: $C_o = 4.7\mu\text{F}$, $V_o \leq 1.7\text{V}$: $C_o = 10\mu\text{F}$

NJM2845/46

■ NJM2846

■ ELECTRICAL CHARACTERISTICS

($V_{IN}=V_o+1V$, $C_{IN}=0.33\mu F$, $C_o=2.2\mu F$ (1.7V< V_o ≤2.6V version: $C_o=4.7\mu F$, V_o ≤1.7V: $C_o=10\mu F$), $T_a=25^\circ C$)

PARAMETER	SYMBOL	TEST CONDITION	MIN.	TYP.	MAX.	UNIT
Output Voltage	V_o	$I_o=30mA$	-1.0%	-	+1.0%	V
Quiescent Current	I_Q	$I_o=0mA$	-	400	600	μA
Quiescent Current at Control OFF	$I_{Q(OFF)}$	$V_{CONT}=0V$	-	-	100	nA
Line Regulation	I_o	$V_o - 0.3V$	800	1050	-	mA
Line Regulation	$\Delta V_o/\Delta V_{IN}$	$V_{IN}=V_o+1V \sim V_o+6V$, $I_o=30mA$	-	-	0.10	%/V
Load Regulation	$\Delta V_o/\Delta I_o$	$I_o=0 \sim 800mA$	-	-	0.004	%/mA
Dropout Voltage(*5)	ΔV_{I-O}	$I_o=500mA$	-	0.18	0.28	V
Ripple Rejection	RR	$e_{in}=200mV_{rms}$, $f=1kHz$, $I_o=10mA$, $V_o=3V$ Version	-	75	-	dB
Average Temperature Coefficient of Output Voltage	$\Delta V_o/\Delta T_a$	$T_a=0 \sim 85^\circ C$, $I_o=10mA$	-	± 50	-	ppm/ $^\circ C$
Output Noise Voltage	V_{NO}	$f=10Hz \sim 80kHz$, $I_o=10mA$, $V_o=3V$ Version	-	45	-	μV_{rms}
Control Current	I_{CONT}	$V_{CONT}=1.6V$, $I_o=0mA$	-	3	12	μA
Control Voltage for ON-state	$V_{CONT(ON)}$		1.6	-	-	V
Control Voltage for OFF-state	$V_{CONT(OFF)}$		-	-	0.6	V

(*5): The output voltage excludes under 2.3V.

The above specification is a common specification for all output voltages.

Therefore, it may be different from the individual specification for a specific output voltage.

■ POWER DISSIPATION vs. AMBIENT TEMPERATURE

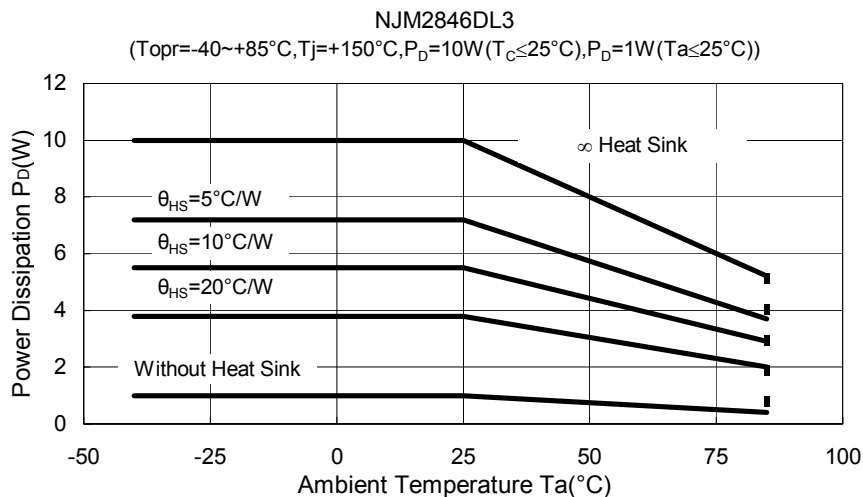

■ TEST CIRCUIT

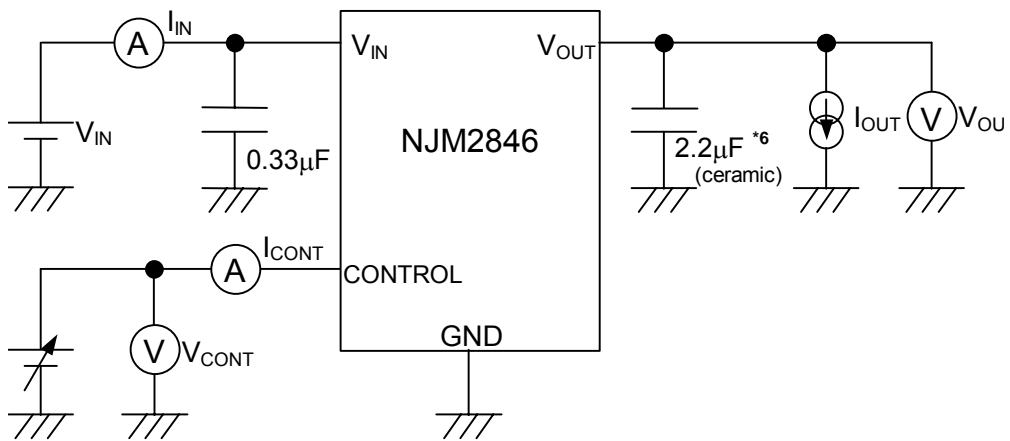

*6 1.7V < V_o ≤ 2.6V version: $C_o = 4.7\mu F$, $V_o \leq 1.7V$: $C_o = 10\mu F$

NJM2845/46

■ TYPICAL APPLICATIONS

① In the case where ON/OFF Control is not required:

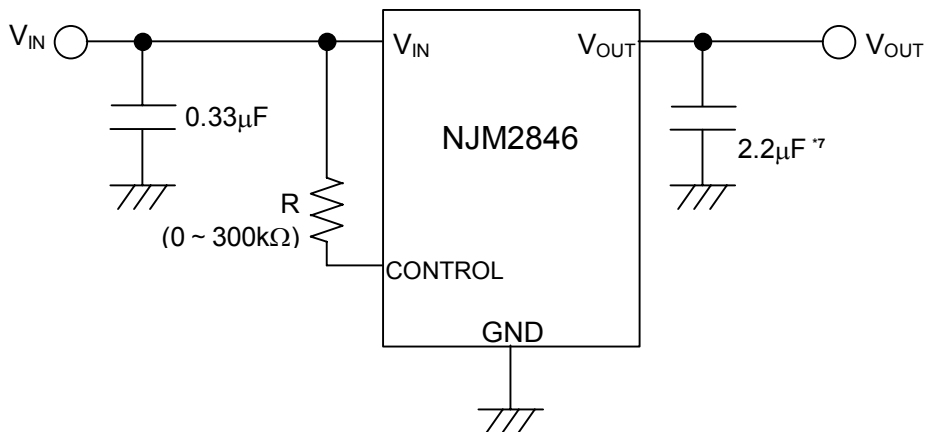

*7 1.7V<V_O≤2.6V version: C_O=4.7µF, V_O≤1.7V: C_O=10µF

Connect control terminal to V_{IN} terminal

② In use of ON/OFF CONTROL:

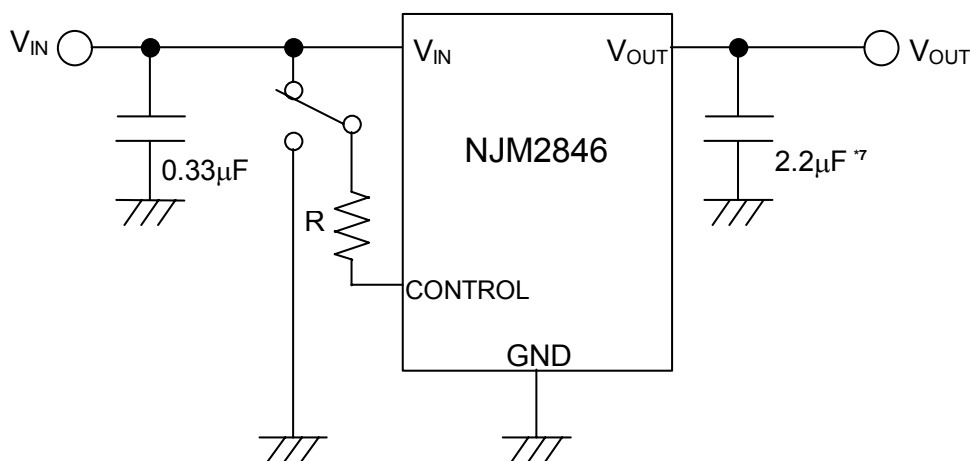

*7 1.7V<V_O≤2.6V version: C_O=4.7µF, V_O≤1.7V: C_O=10µF

State of control terminal:

- “H”→ output is enabled.
- “L” or “open” → output is disabled.

*In the case of using a resistance "R" between V_{IN} and control.

The current flow into the control terminal while the IC is ON state (I_{CONT}) can be reduced when a pull up resistance "R" is inserted between V_{IN} and the control terminal.

The minimum control voltage for ON state (V_{CONT(ON)}) is increased due to the voltage drop caused by I_{CONT} and the resistance "R". The I_{CONT} is temperature dependence as shown in the "Control Current vs. Temperature" characteristics. Therefore, the resistance "R" should be carefully selected to ensure the control voltage exceeds the V_{CONT(ON)} over the required temperature range.

*Input Capacitance C_{IN}

Input capacitance C_{IN} is required to prevent oscillation and reduce power supply ripple for applications with high power supply impedance or a long power supply line.

Use the C_{IN} value of 0.33 μ F greater to avoid the problem.

C_{IN} should connect between GND and V_{IN} as short as possible.

*Output Capacitance C_O

Output capacitor (C_O) is required for a phase compensation of the internal error amplifier. The capacitance and the equivalent series resistance (ESR) influences stability of the regulator.

This product is designed to work with a low ESR capacitor for the C_O ; however, use of recommended capacitance or greater value is essential for stable operation.

Use of a smaller C_O may cause excess output noise or oscillation of the regulator due to lack of the phase compensation.

Therefore, use C_O with the recommended capacitance or greater value and connect between V_O terminal and GND terminal with minimal wiring. The recommended capacitance depends on the output voltage. Low voltage regulator requires greater value of the C_O . Thus, check the recommended capacitance for each output voltage.

Use of a greater C_O reduces output noise and ripple output, and also improves transient response of the output voltage against rapid load change.

NJM2845/46

■ TYPICAL CHARACTERISTICS (NJM2845)

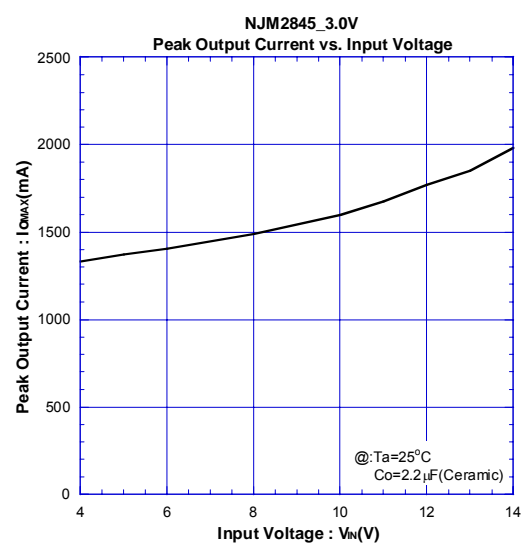
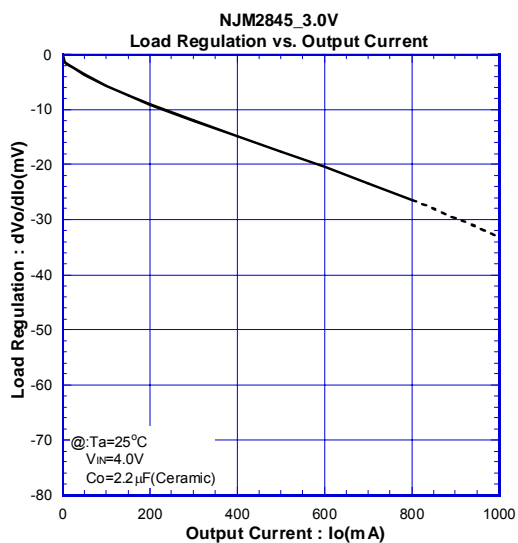
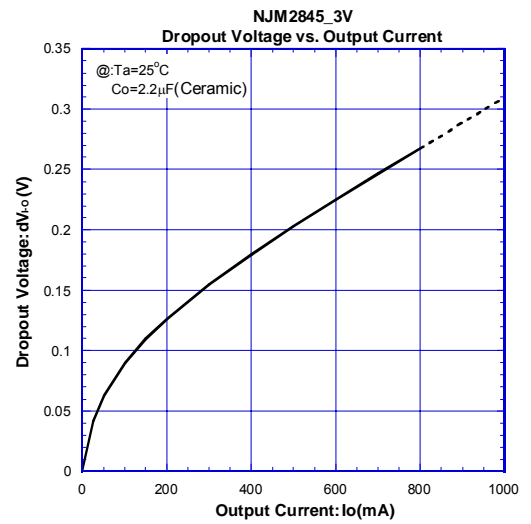
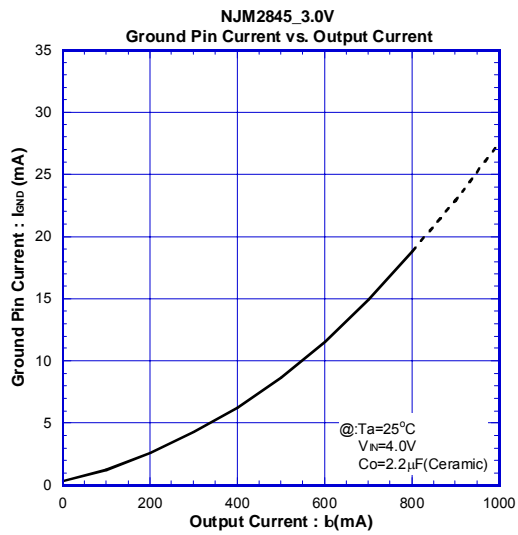
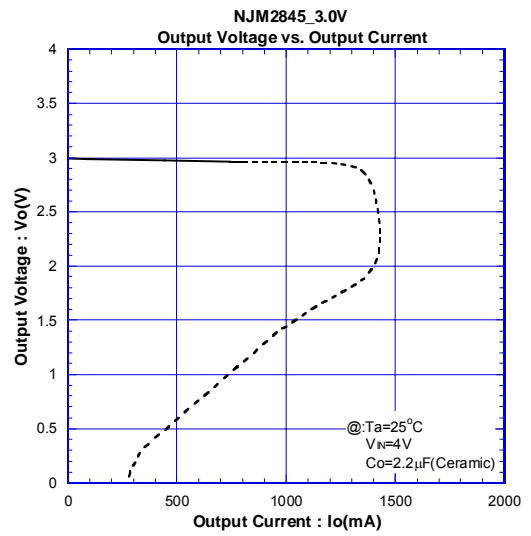
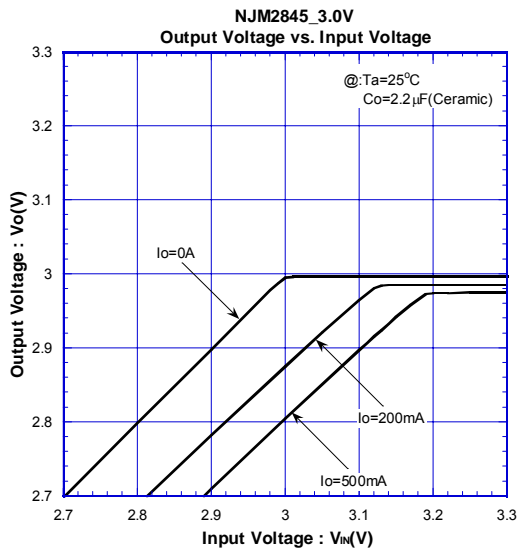

■ TYPICAL CHARACTERISTICS (NJM2845)

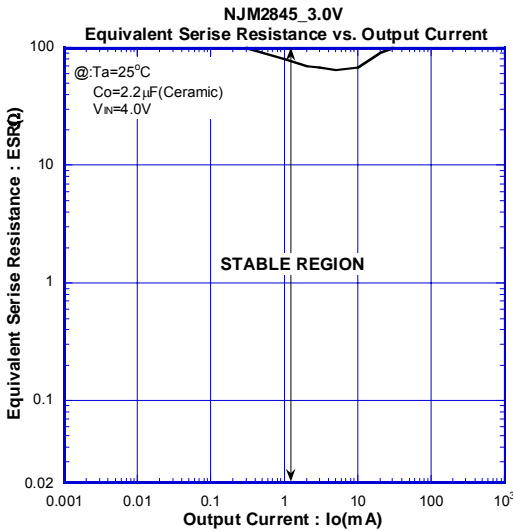
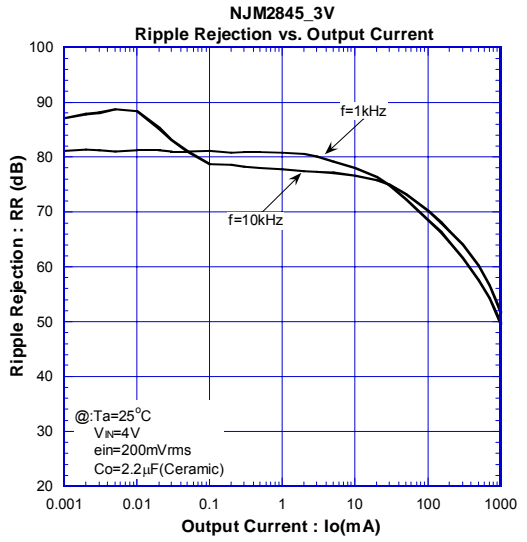
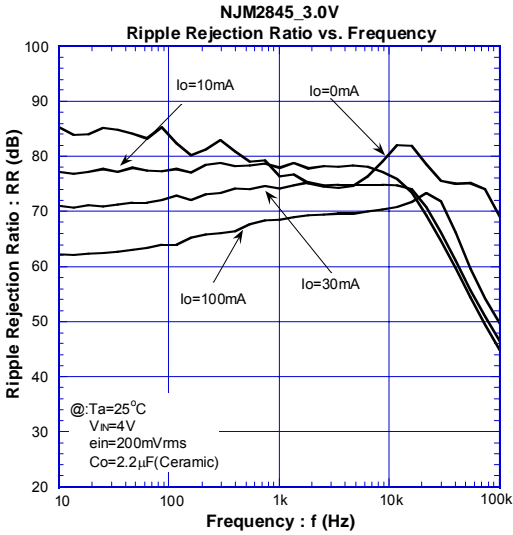
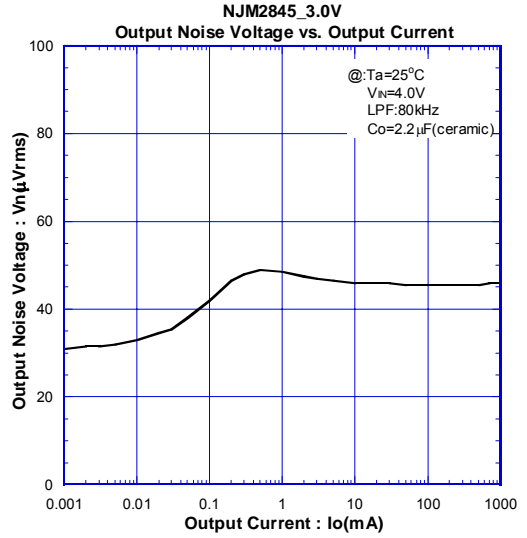
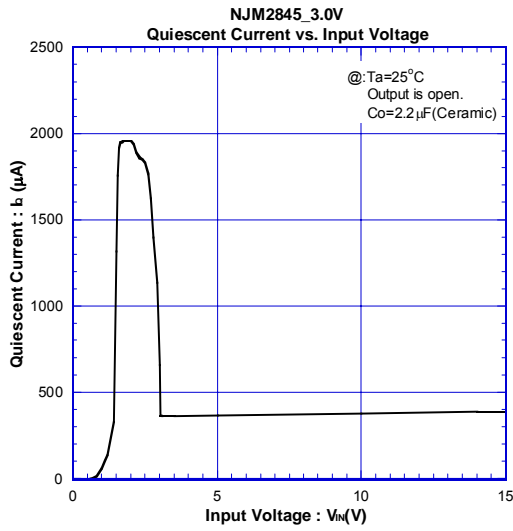

NJM2845/46

TYPICAL CHARACTERISTICS (NJM2845)

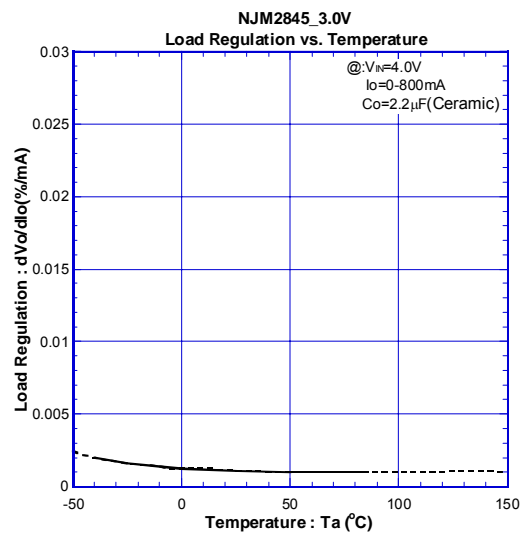
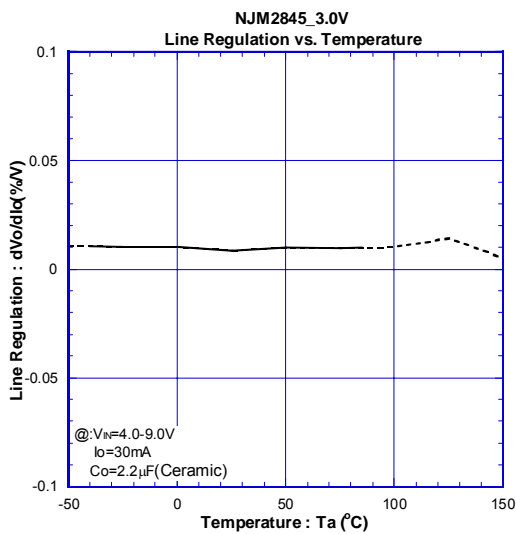
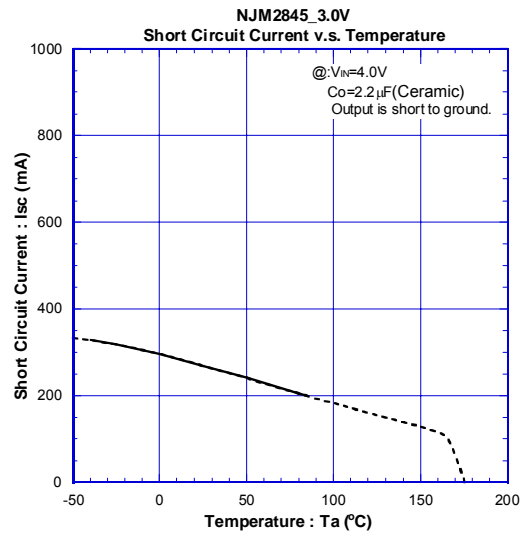
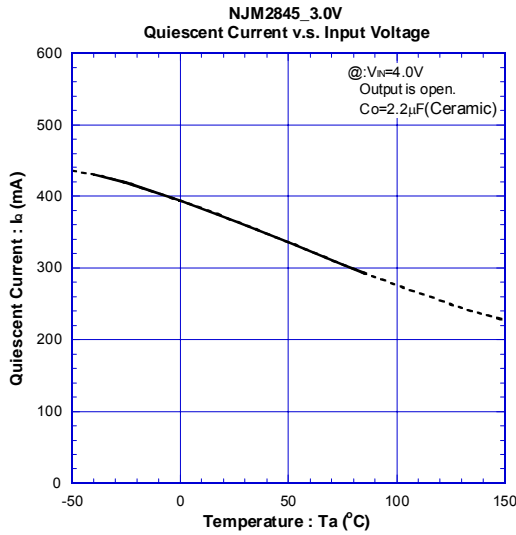
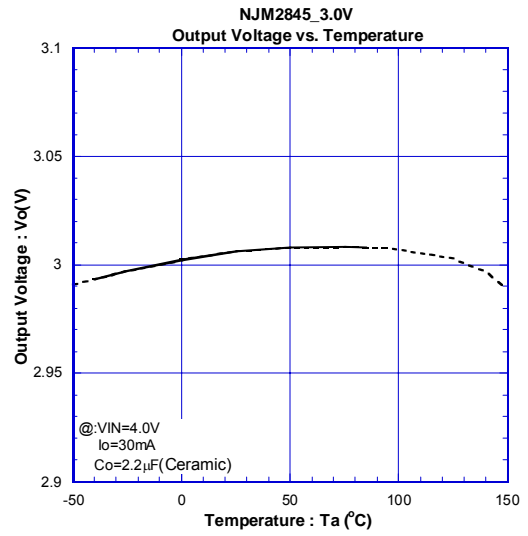
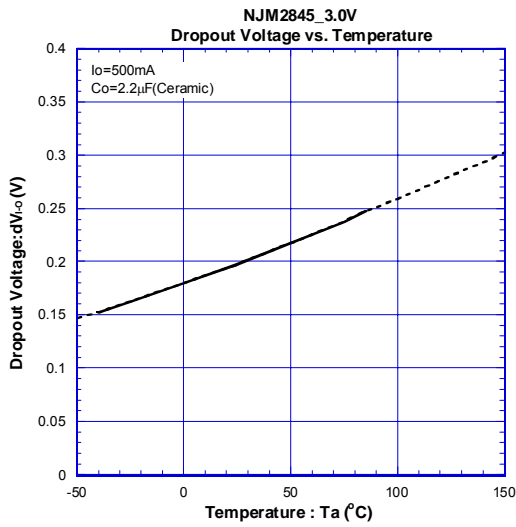

■ TYPICAL CHARACTERISTICS (NJM2845)

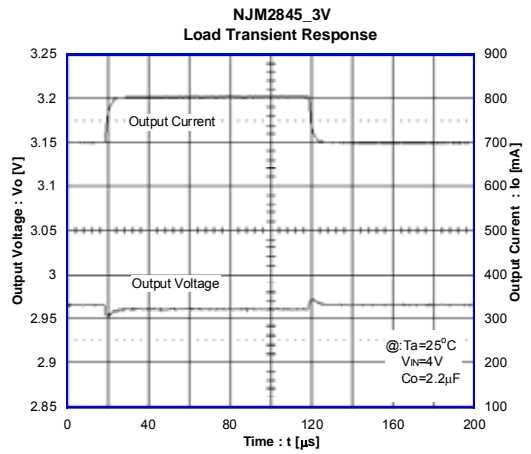
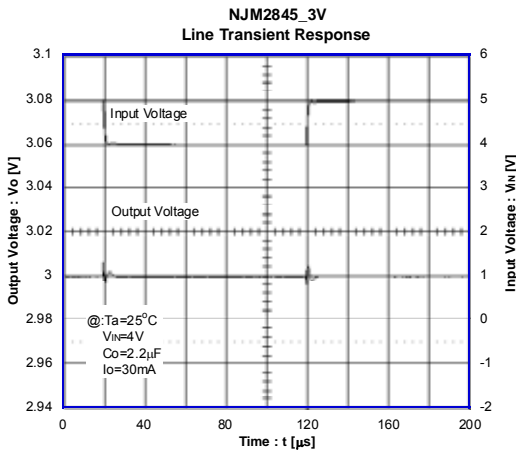
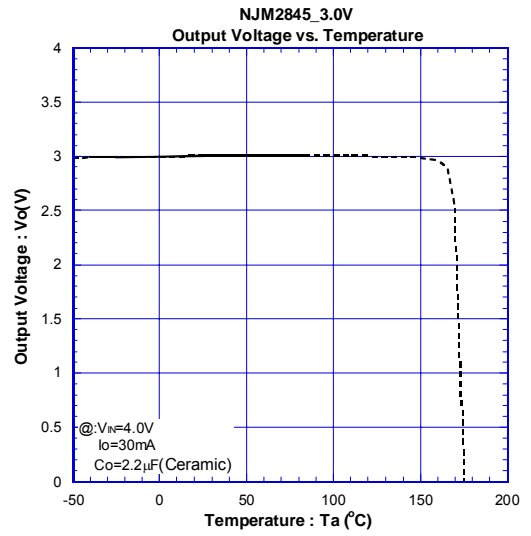
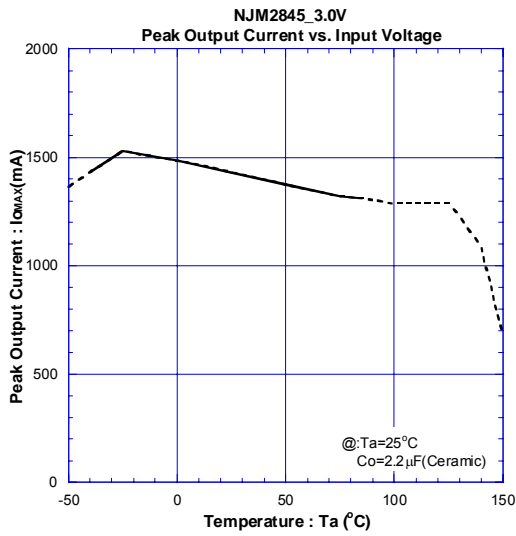

NJM2845/46

■ TYPICAL CHARACTERISTICS (NJM2846)

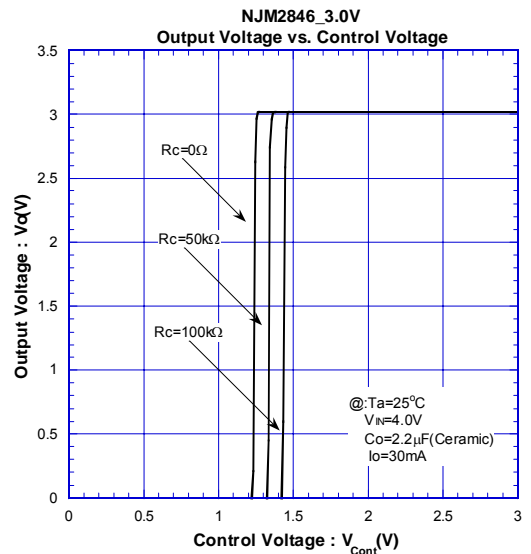
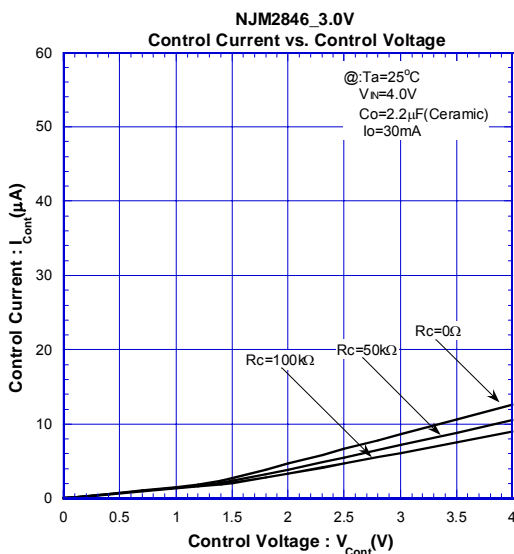
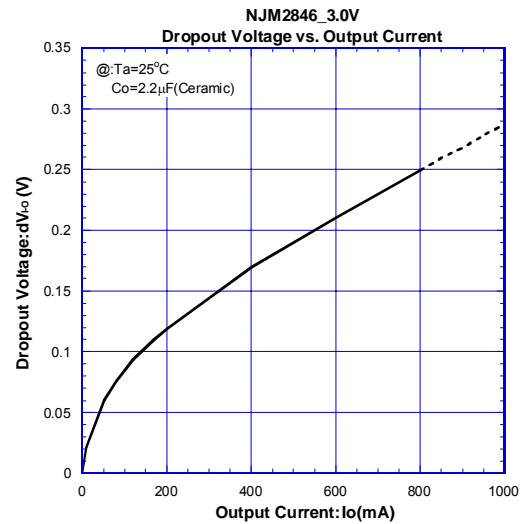
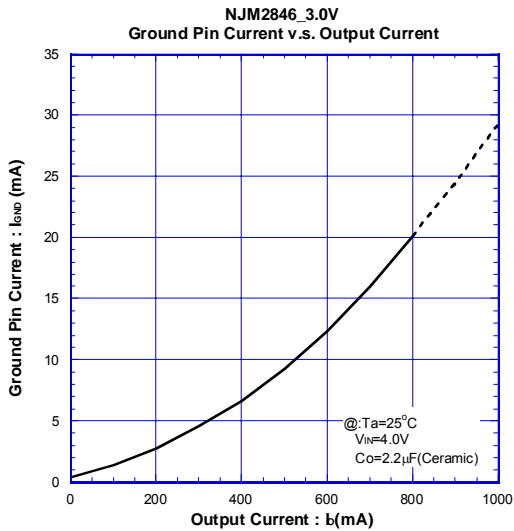
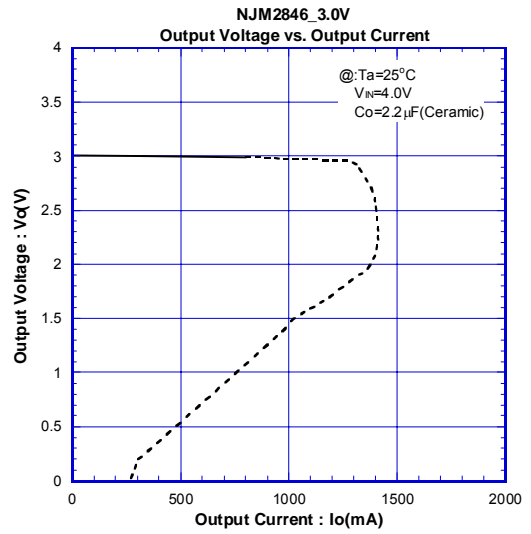
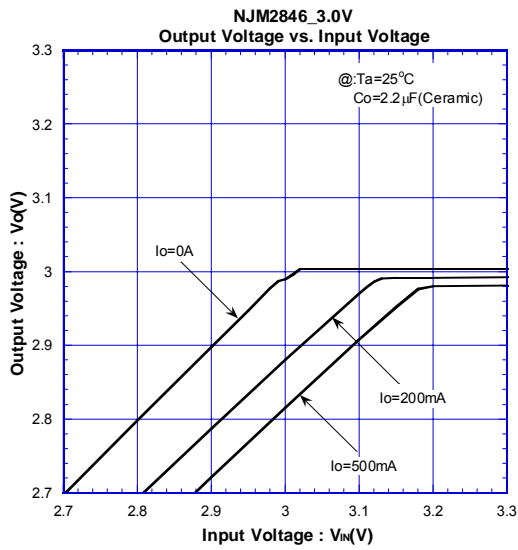

■ TYPICAL CHARACTERISTICS (NJM2846)

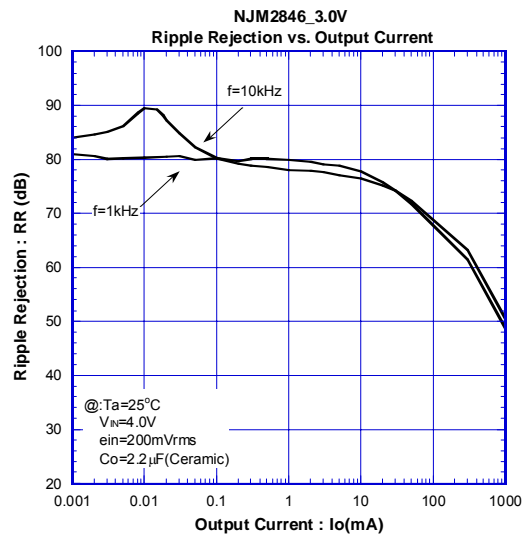
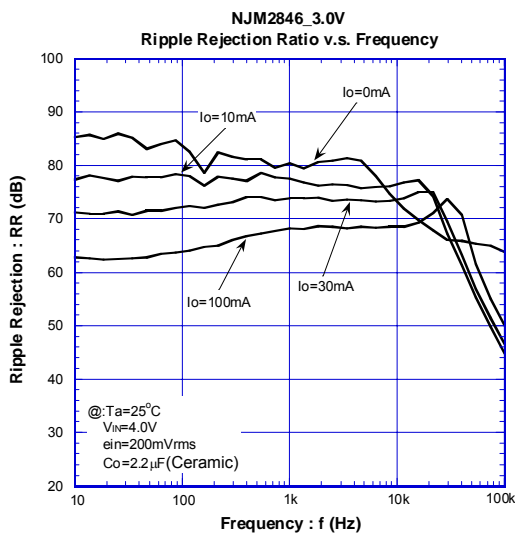
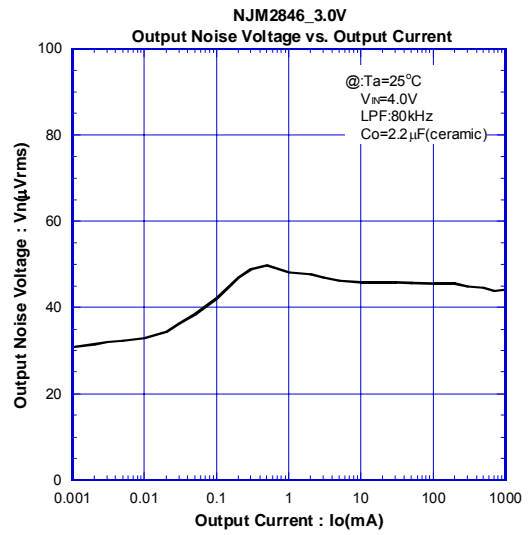
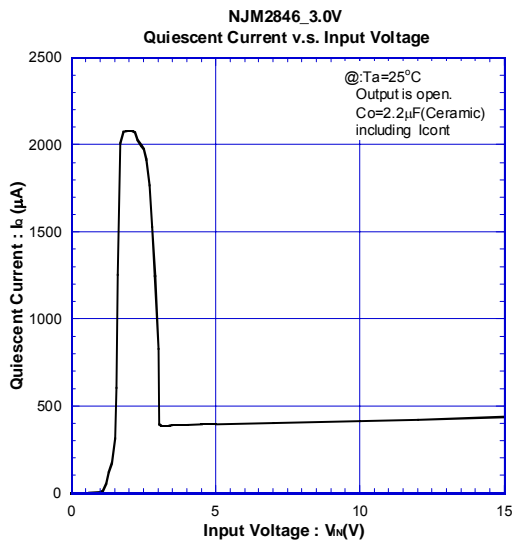
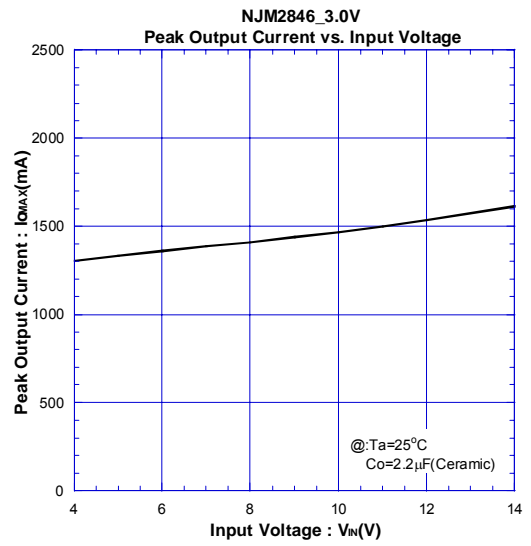
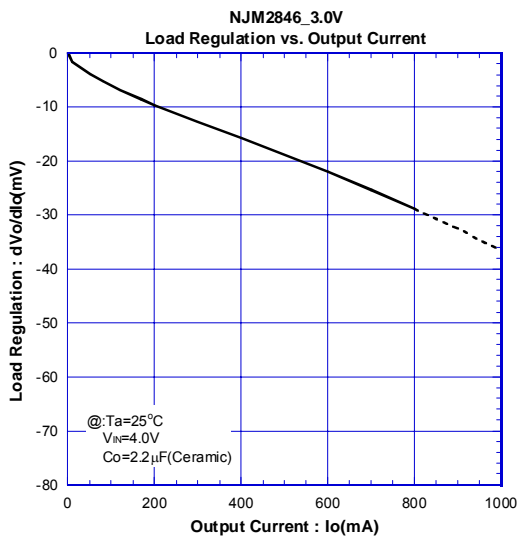

NJM2845/46

■ TYPICAL CHARACTERISTICS (NJM2846)

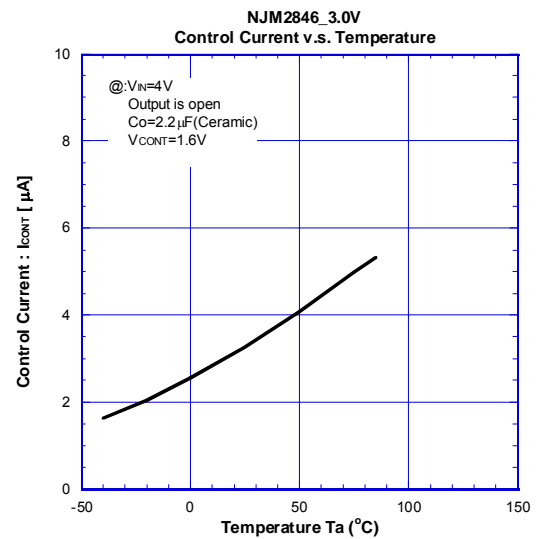
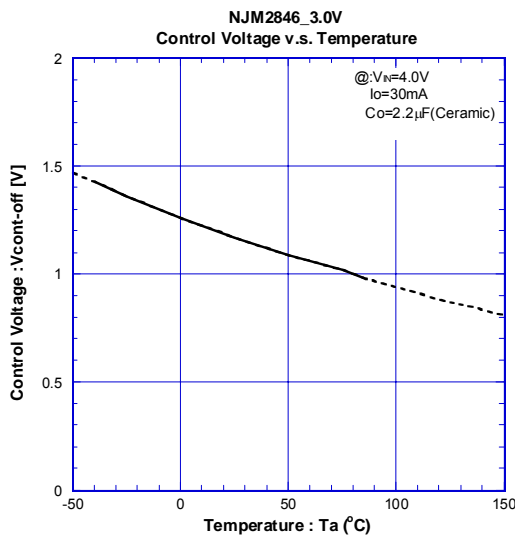
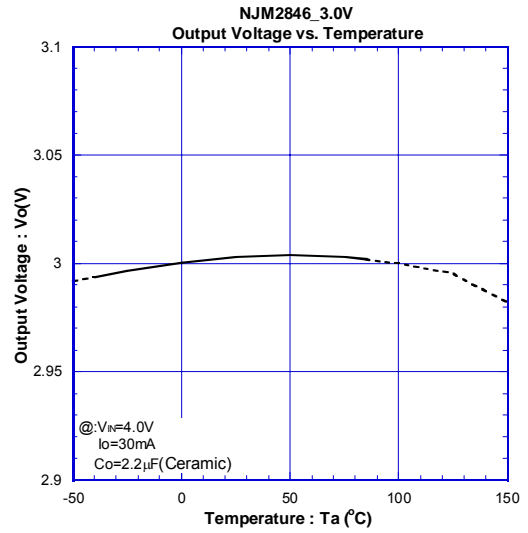
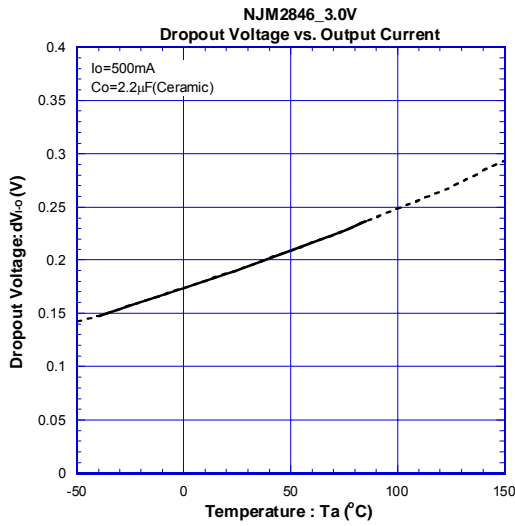
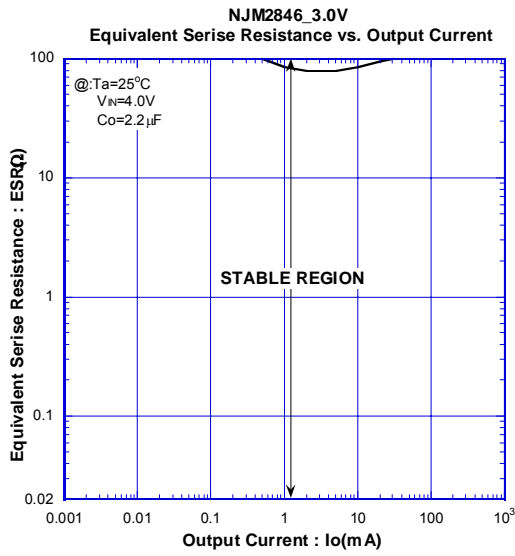

■ TYPICAL CHARACTERISTICS (NJM2846)

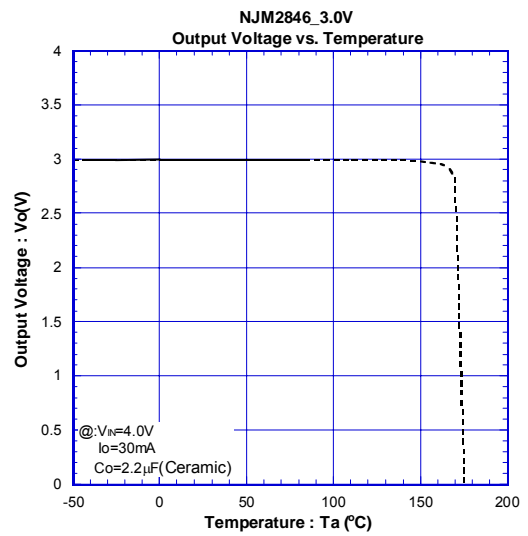
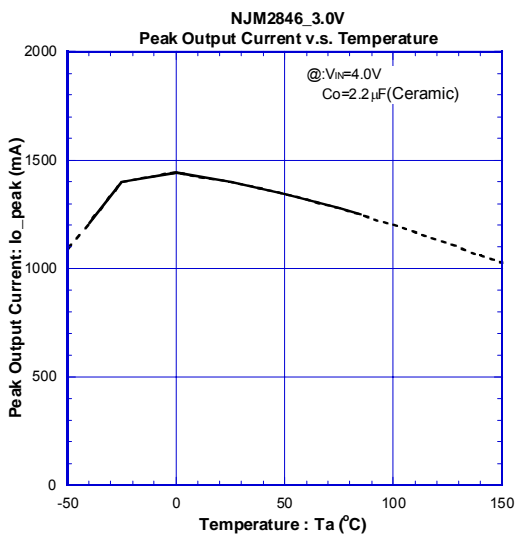
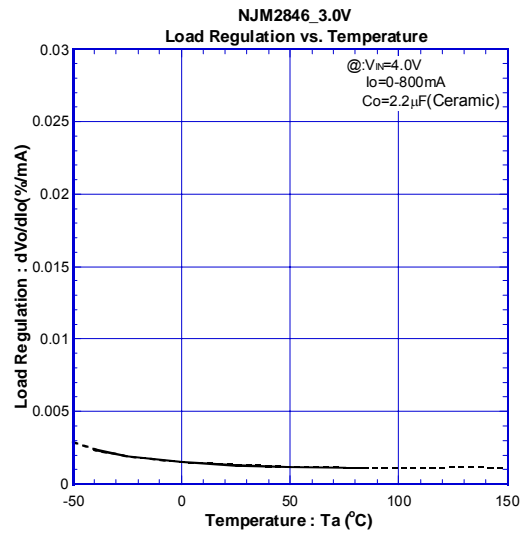
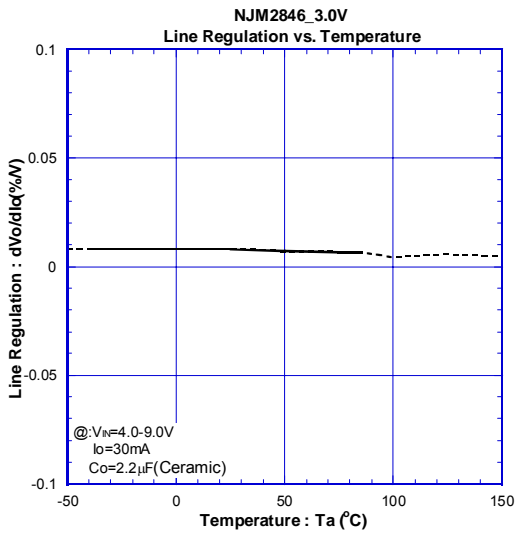
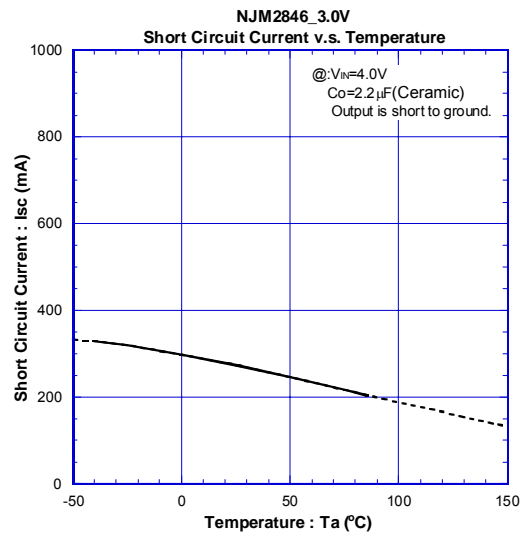
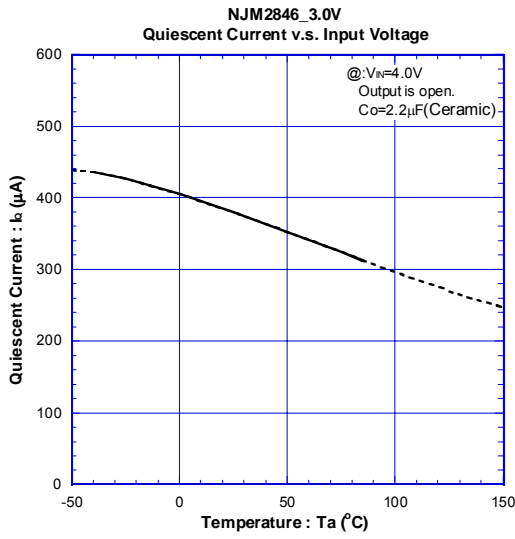

NJM2845/46

■ TYPICAL CHARACTERISTICS (NJM2846)

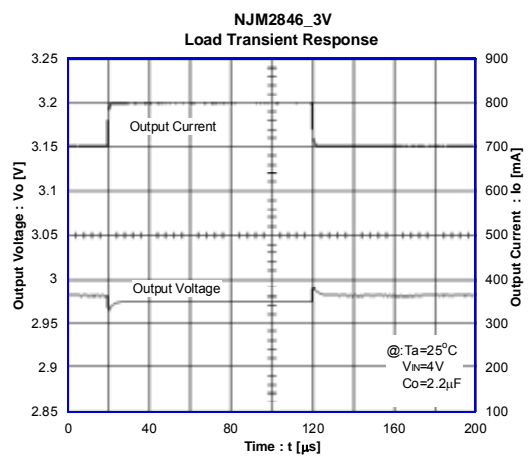
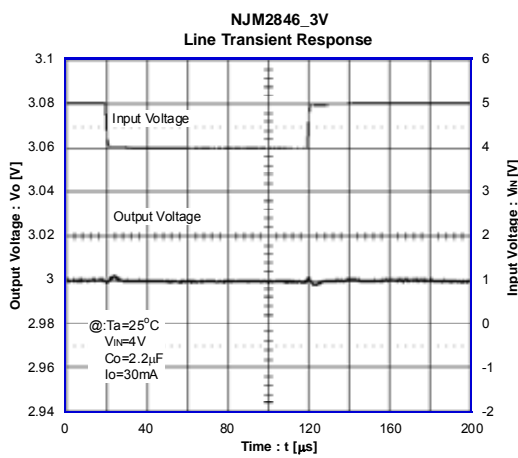
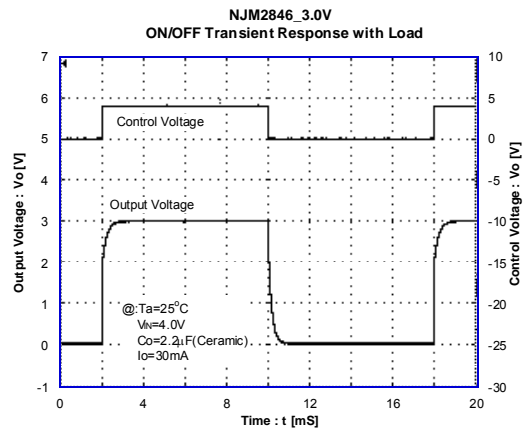
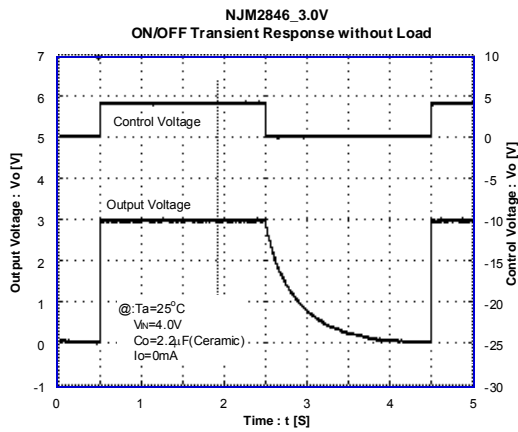

[CAUTION]
The specifications on this databook are only given for information, without any guarantee as regards either mistakes or omissions. The application circuits in this databook are described only to show representative usages of the product and not intended for the guarantee or permission of any right including the industrial rights.

Looking for pricing, stock, or lifecycle information?

Click below to explore more details on WIN SOURCE:

- ⊖ [View NJM2846DL3-04-TE1 on WIN SOURCE](#)
- ⊖ [NJR Corporation/NJRC Information](#)

Optimize Your Supply Chain with WIN SOURCE Solutions

- ✓ Global Sourcing Solution
- ✓ Obsolete Management
- ✓ Cost Control Management
- ✓ Shortage Management
- ✓ Alternative Solution
- ✓ Excess Inventory Management