

## LOW DROPOUT VOLTAGE REGULATOR

### ■ GENERAL DESCRIPTION

The NJM2860 is a low dropout voltage regulator. Advanced Bipolar technology achieves low noise, high ripple rejection and low quiescent current. It features small SC-88A package.

### ■ PACKAGE OUTLINE



NJM2860F3

### ■ FEATURES

- High Ripple Rejection 70dB typ. (f=1kHz, Vo=3V Version)
- Output Noise Voltage Vno=30μVrms typ. (Cp=0.01μF)
- Output capacitor with 1.0uF ceramic capacitor (Vo≥2.7V)
- Output Current Io(max.)=100mA
- High Precision Output Vo±1.0%
- Low Dropout Voltage 0.10V typ. (Io=60mA)
- ON/OFF Control (Active High)
- Internal Short Circuit Current Limit
- Internal Thermal Overload Protection
- Bipolar Technology
- Package Outline SC88A

### ■ PIN CONFIGURATION

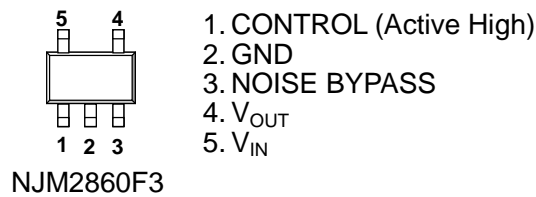

### ■ EQUIVALENT CIRCUIT

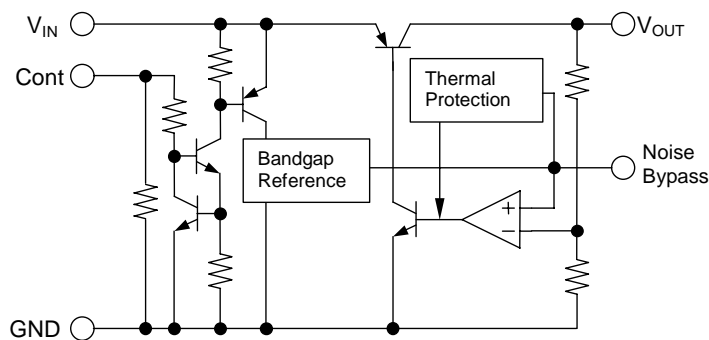

## ■ OUTPUT VOLTAGE RANK LIST

Device Name	V <sub>OUT</sub>
NJM2860F3-15	1.5V
NJM2860F3-18	1.8V
NJM2860F3-19	1.9V
NJM2860F3-21	2.1V
NJM2860F3-25	2.5V
NJM2860F3-26	2.6V
NJM2860F3-27	2.7V

Device Name	V <sub>OUT</sub>
NJM2860F3-28	2.8V
NJM2860F3-285	2.85V
NJM2860F3-03	3.0V
NJM2860F3-31	3.1V
NJM2860F3-32	3.2V
NJM2860F3-33	3.3V
NJM2860F3-35	3.5V

Device Name	V <sub>OUT</sub>
NJM2860F3-355	3.55V
NJM2860F3-38	3.8V
NJM2860F3-04	4.0V
NJM2860F3-46	4.6V
NJM2860F3-47	4.7V
NJM2860F3-05	5.0V

## ■ ABSOLUTE MAXIMUM RATINGS (Ta=25°C)

PARAMETER	SYMBOL	RATINGS	UNIT
Input Voltage	V <sub>IN</sub>	+14	V
Control Voltage	V <sub>CONT</sub>	+14(*1)	V
Power Dissipation	P <sub>D</sub>	250(*2)	mW
Operating Temperature	Topr	-40 ~ +85	°C
Storage Temperature	Tstg	-40 ~ +125	°C

(\*1):When input voltage is less than +14V, the absolute maximum control voltage is equal to the input voltage.

(\*2):Mounted on glass epoxy board based on EIA/JEDEC. (114.3x76.2x1.6mm: 2Layers)

## ■ Operating voltage

V<sub>IN</sub>=+2.5V ~ +14.0V (In case of Vo<2.1V)

## ■ ELECTRICAL CHARACTERISTICS

(V<sub>IN</sub>=Vo+1V, C<sub>IN</sub>=0.1μF, Co=1.0uF: Vo≥2.7V (Co=2.2uF: Vo≤2.6V), Cp=0.01μF, Ta=25°C)

PARAMETER	SYMBOL	TEST CONDITION	MIN.	TYP.	MAX.	UNIT
Output Voltage	Vo	Io=30mA	-1.0%	-	+1.0%	V
Quiescent Current	I <sub>Q</sub>	Io=0mA, expect Icont	-	120	180	μA
Quiescent Current at Control OFF	I <sub>Q(OFF)</sub>	V <sub>CONT</sub> =0V	-	-	100	nA
Output Current	Io	Vo=0.3V	100	130	-	mA
Line Regulation	ΔVo/ΔV <sub>IN</sub>	V <sub>IN</sub> =Vo+1V ~ Vo+6V, Io=30mA	-	-	0.10	%/V
Load Regulation	ΔVo/ΔIo	Io=0 ~ 60mA	-	-	0.03	%/mA
Dropout Voltage(*3)	ΔV <sub>L-O</sub>	Io=60mA	-	0.10	0.18	V
Ripple Rejection	RR	ein=200mVrms, f=1kHz, Io=10mA, Vo=3V Version	-	70	-	dB
Average Temperature Coefficient of Output Voltage	ΔVo/ΔTa	Ta=0~85°C, Io=10mA	-	±50	-	ppm/°C
Output Noise Voltage	V <sub>NO</sub>	f=10Hz~80kHz, Io=10mA, Vo=3V Version	-	30	-	μVrms
Control Voltage for ON-state	V <sub>CONT(ON)</sub>		1.6	-	-	V
Control Voltage for OFF-state	V <sub>CONT(OFF)</sub>		-	-	0.6	V

(\*3): The output voltage excludes under 2.1V.

The above specification is a common specification for all output voltages.

Therefore, it may be different from the individual specification for a specific output voltage.

■ TEST CIRCUIT

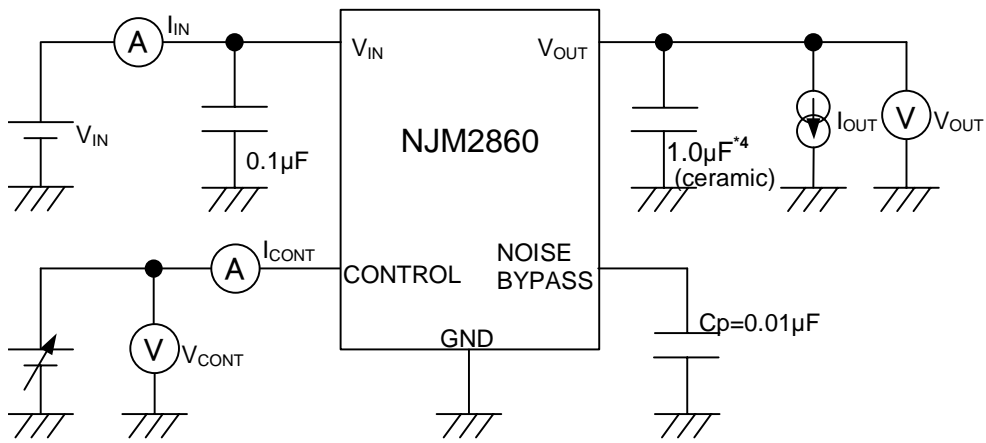

\*4  $V_o \leq 2.6V$  version:  $C_o = 2.2\mu F$  (ceramic)

## ■ TYPICAL APPLICATION

① In the case where ON/OFF Control is not required:

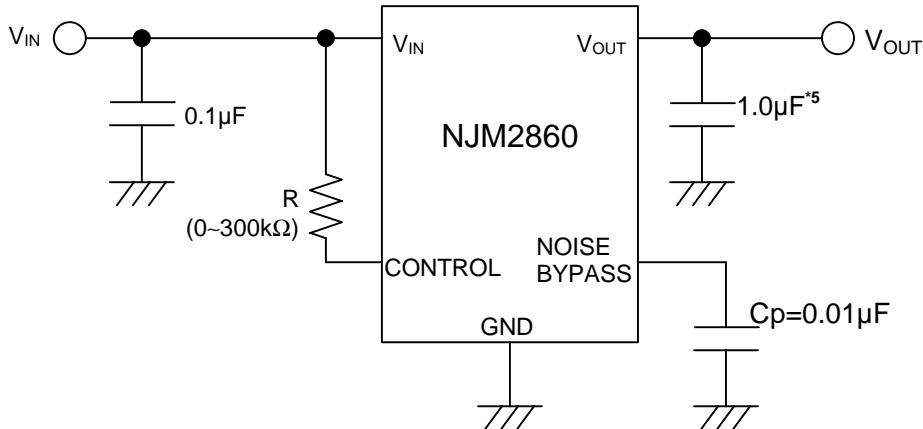

\*5  $V_o \leq 2.6V$  version:  $C_o = 2.2\mu F$

Connect control terminal to  $V_{IN}$  terminal

② In use of ON/OFF CONTROL:

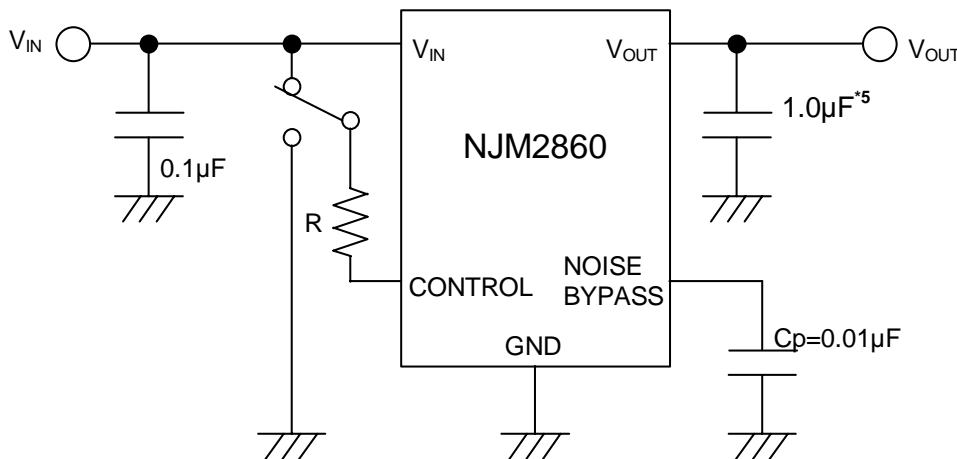

\*5  $V_o \leq 2.6V$  version:  $C_o = 2.2\mu F$

State of control terminal:

- "H" → output is enabled.
- "L" or "open" → output is disabled.

### \*Noise bypass Capacitance $C_p$

Noise bypass capacitance  $C_p$  reduces noise generated by band-gap reference circuit. Noise level and ripple rejection will be improved when larger  $C_p$  is used. Use of smaller  $C_p$  value may cause oscillation. Use the  $C_p$  value of  $0.01\mu F$  greater to avoid the problem.

### \*In the case of using a resistance "R" between $V_{IN}$ and control.

The current flow into the control terminal while the IC is ON state ( $I_{CONT}$ ) can be reduced when a pull up resistance "R" is inserted between  $V_{IN}$  and the control terminal. The minimum control voltage for ON state ( $V_{CONT(ON)}$ ) is increased due to the voltage drop caused by  $I_{CONT}$  and the resistance "R". The  $I_{CONT}$  is temperature dependence as shown in the "Control Current vs. Temperature" characteristics. Therefore, the resistance "R" should be carefully selected to ensure the control voltage exceeds the  $V_{CONT(ON)}$  over the required temperature range.

## ■ POWER DISSIPATION vs. AMBIENT TEMPERATURE

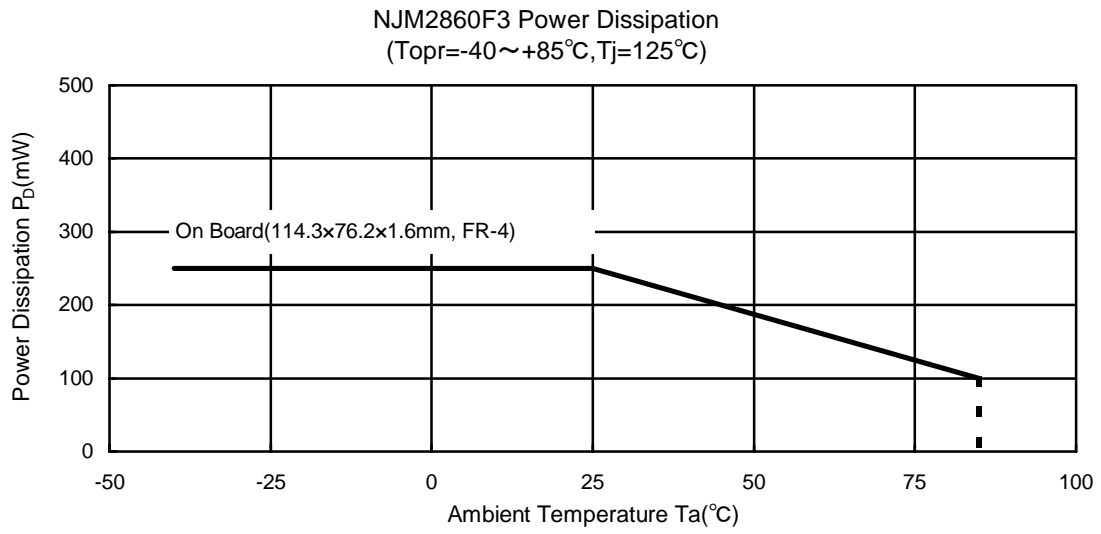

## TYPICAL CHARACTERISTICS

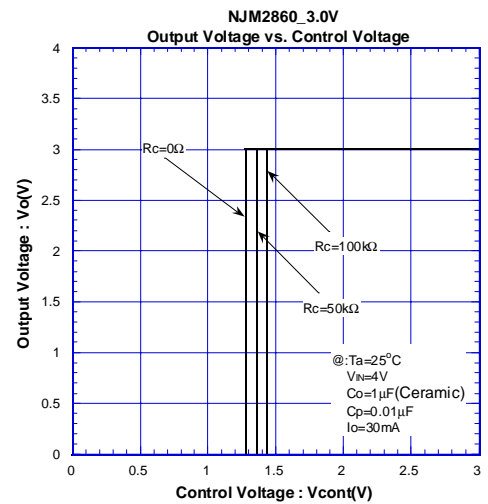
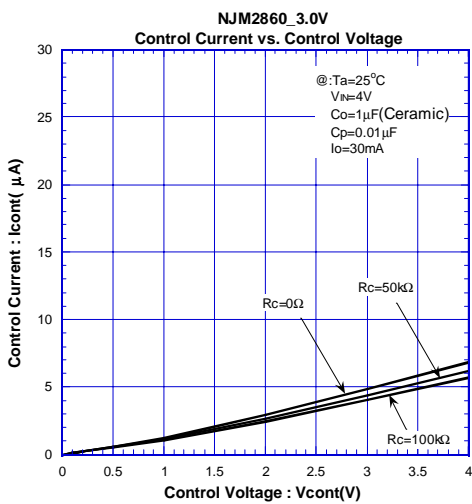
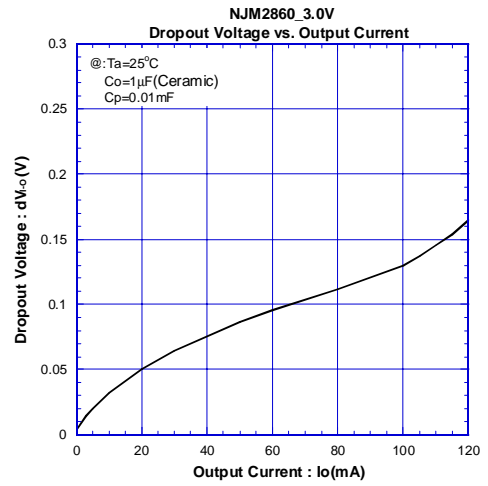
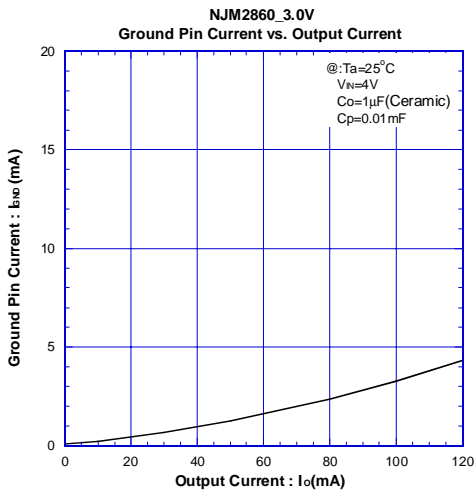
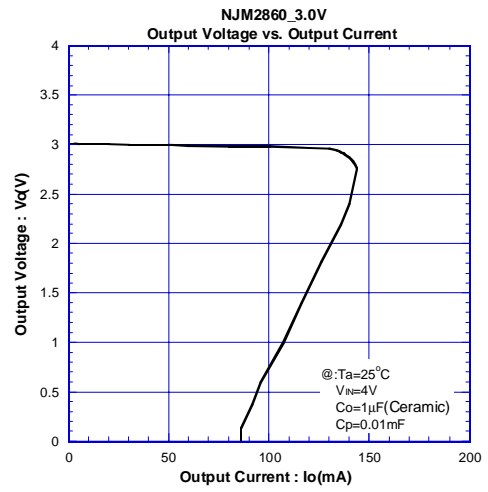
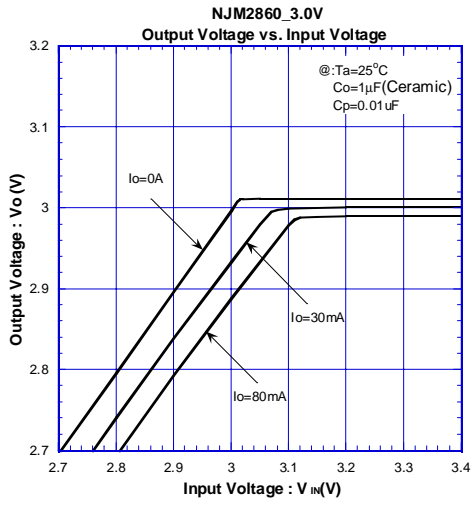

## TYPICAL CHARACTERISTICS

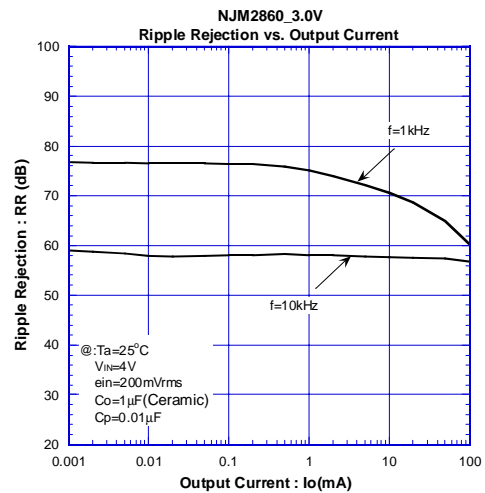
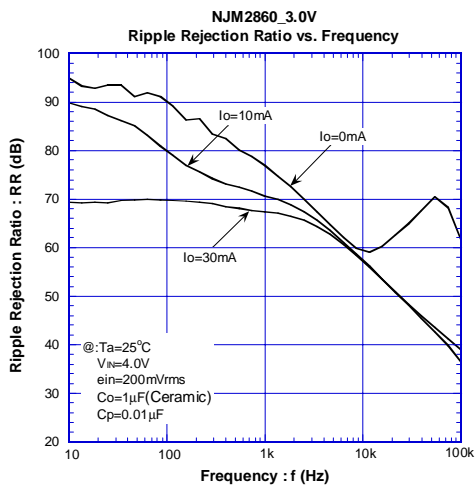
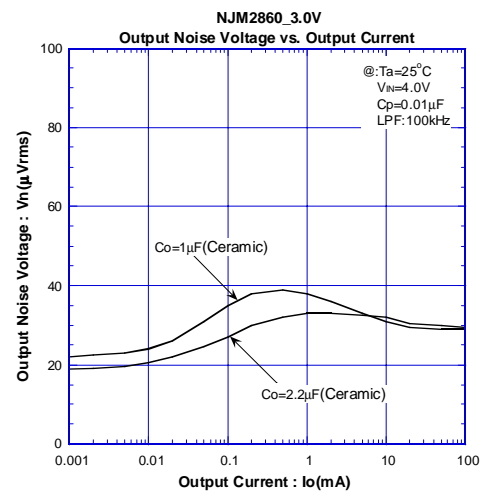
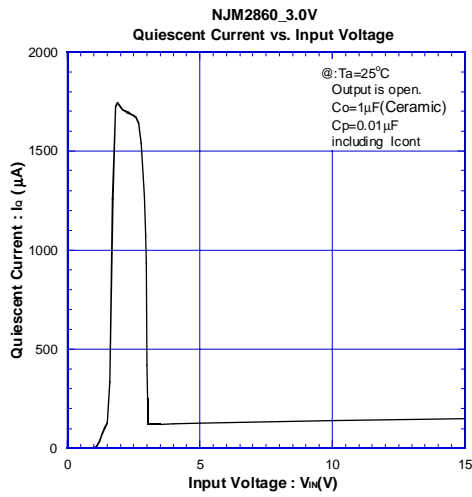
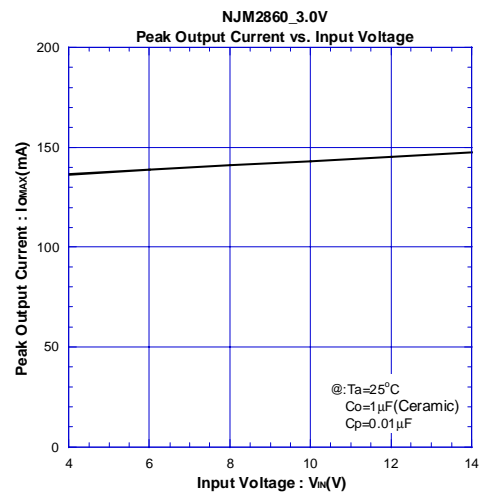
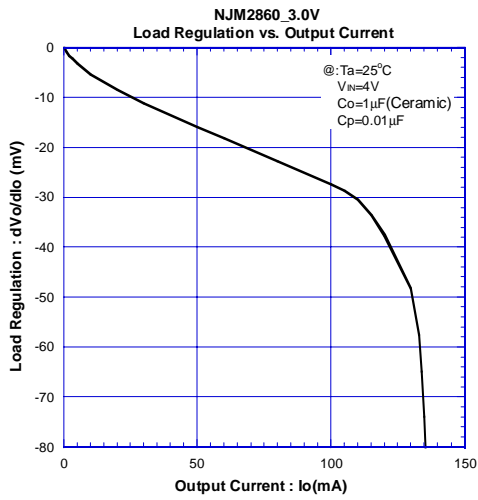

## TYPICAL CHARACTERISTICS

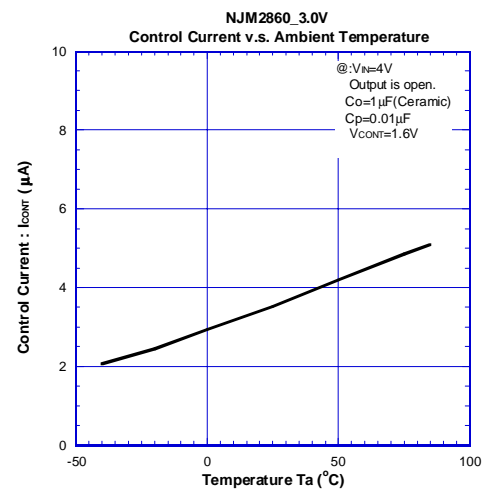
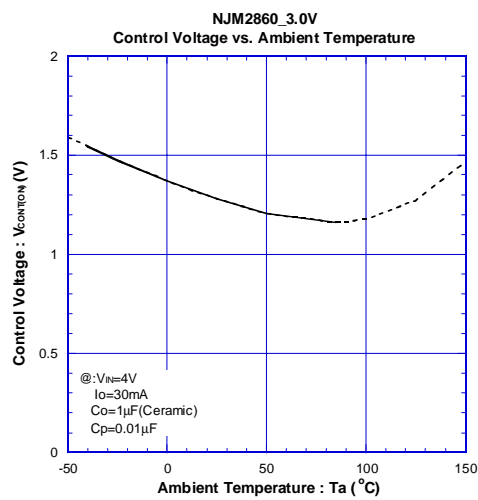
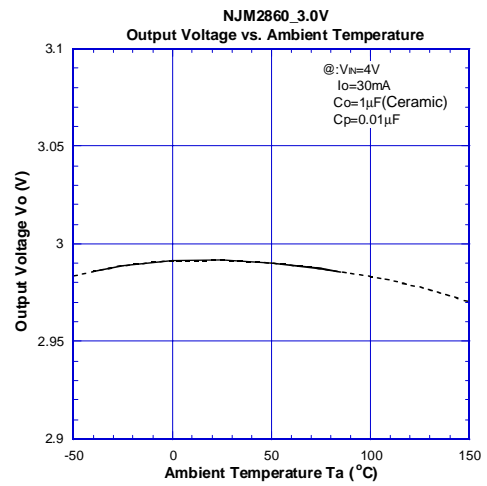
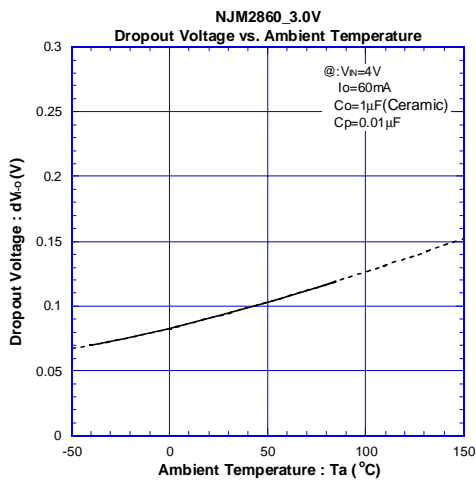
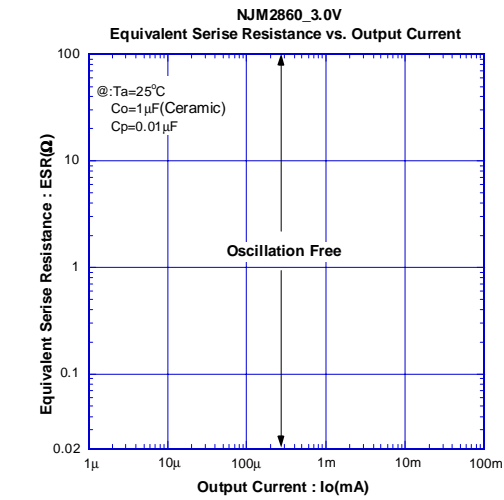

## TYPICAL CHARACTERISTICS

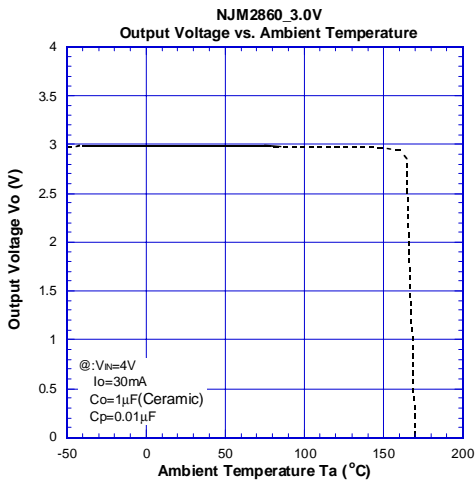
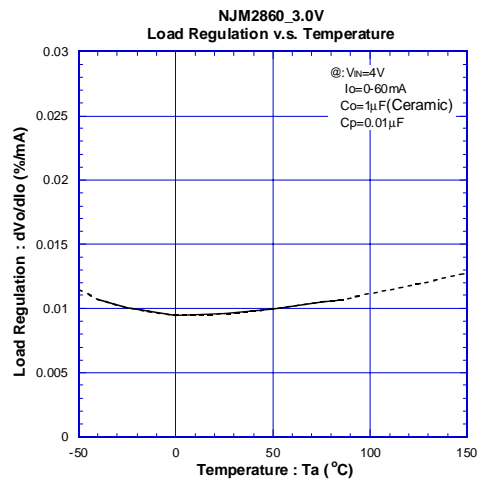
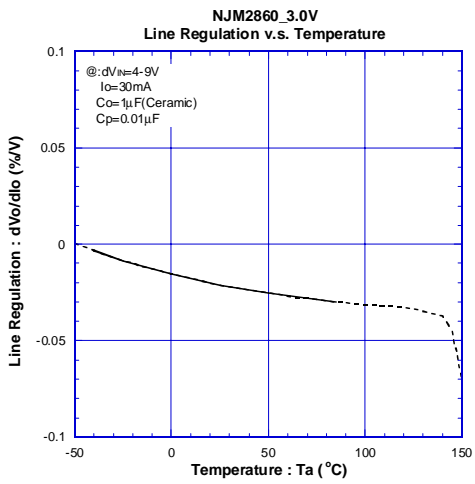
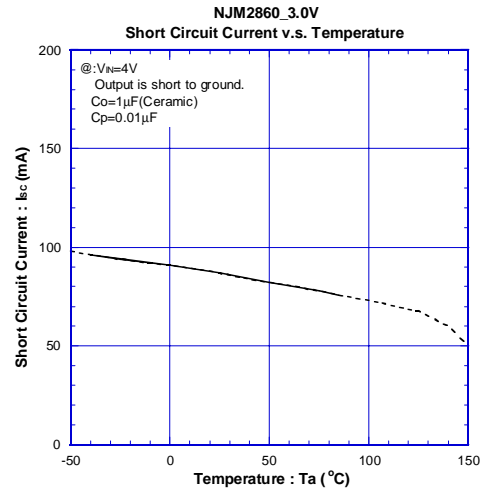
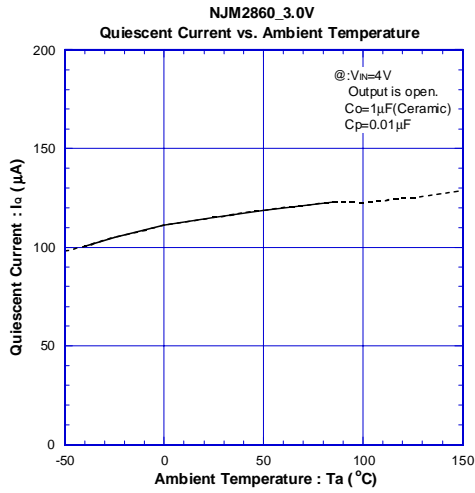

## TYPICAL CHARACTERISTICS

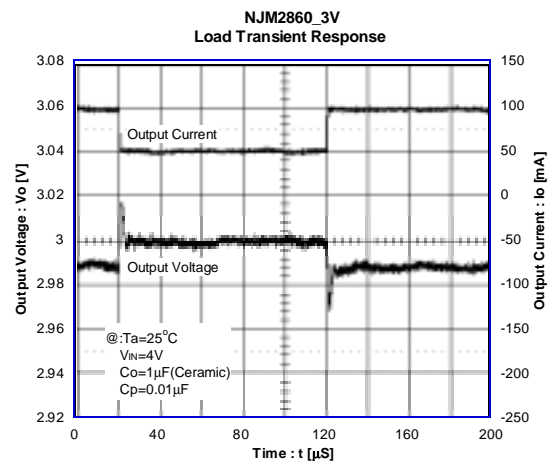
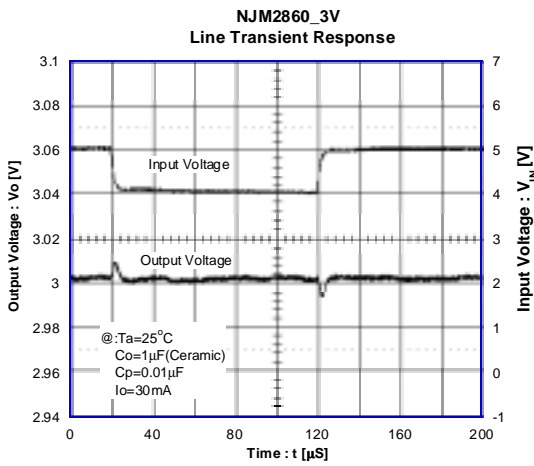
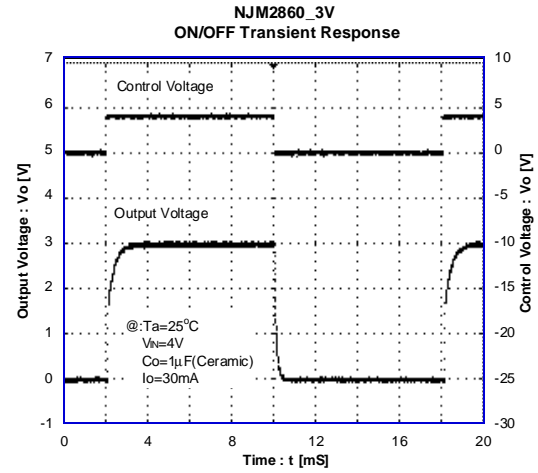
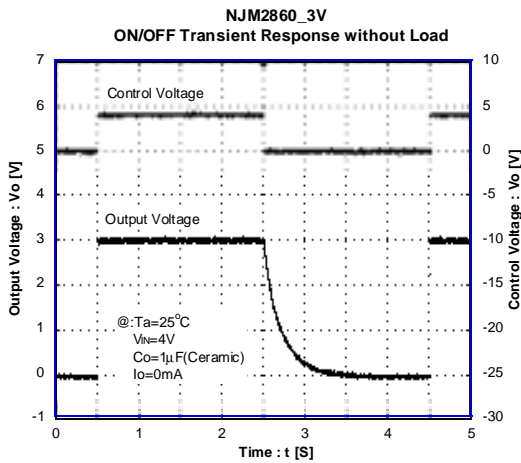



**[CAUTION]**

The specifications on this databook are only given for information, without any guarantee as regards either mistakes or omissions. The application circuits in this databook are described only to show representative usages of the product and not intended for the guarantee or permission of any right including the industrial rights.

## Looking for pricing, stock, or lifecycle information?

Click below to explore more details on WIN SOURCE:

-  [View NJM2860F3-27 on WIN SOURCE](#)
-  [NJR Corporation/NJRC Information](#)

## Optimize Your Supply Chain with WIN SOURCE Solutions

-  Global Sourcing Solution
-  Obsolete Management
-  Cost Control Management
-  Shortage Management
-  Alternative Solution
-  Excess Inventory Management