

SINGLE-SUPPLY QUAD OPERATIONAL AMPLIFIER

■ GENERAL DESCRIPTION

The NJM3403A is high performance ground sensing quad operational amplifier featuring the high slew rate and no crossover distortion.

The NJM3403A is improved version of the NJM2902.

■ FEATURES

- Single Supply
- Operating Voltage (+4V~+36V)
- Low Operating Current (3mA typ.)
- Slew Rate (1.2V/μs typ.)
- Package Outline DIP14,DMP14,SSOP14
- Bipolar Technology

■ PACKAGE OUTLINE

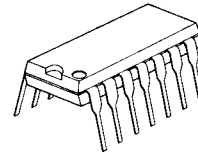

NJM3403AD

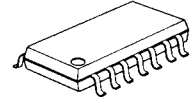

NJM3403AM

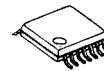

NJM3403AV

■ PIN CONFIGURATION

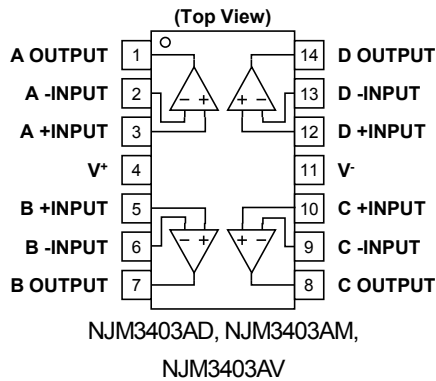

■ EQUIVALENT CIRCUIT (1/4 Shown)

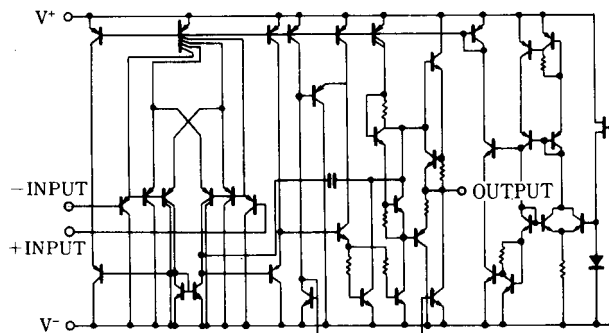

NJM3403A

■ ABSOLUTE MAXIMUM RATINGS

(Ta=25°C)

PARAMETER	SYMBOL	RATINGS	UNIT
Supply Voltage	$V^+(V^-/V)$	36 (or ± 18)	V
Differential Input Voltage	V_{ID}	36	V
Input Voltage	V_{IC}	-0.3~+36	V
Power Dissipation	P_D	(DIP14) 500 (DMP14) 300 (SSOP14) 300	mW
Operating Temperature Range	T_{opr}	-40~+85	°C
Storage Temperature Range	T_{stg}	-40~+125	°C

■ ELECTRICAL CHARACTERISTICS

(Ta=25°C, $V^+/V^- = \pm 15V$)

PARAMETER	SYMBOL	TEST CONDITION	MIN.	TYP.	MAX.	UNIT
Input Offset Voltage	V_{IO}	$R_S=0\Omega$	-	2	5	mV
Input Offset Current	I_{IO}		-	5	50	nA
Input Bias Current	I_B		-	70	200	nA
Large Signal Voltage Gain	A_V	$R_L > 2k\Omega$	88	100	-	dB
Maximum Output Voltage Swing	V_{OM}	$R_L = 2k\Omega$	± 13	± 14	-	V
Input Common Mode Voltage Range	V_{ICM}		-15~+13	-	-	V
Common Mode Rejection Ratio	CMR	DC	70	90	-	dB
Supply Voltage Rejection Ratio	SVR		80	94	-	dB
Output Source Current	I_{SOURCE}	$V_{IN}^+ = 1V, V_{IN}^- = 0V$	20	30	-	mA
Output Sink Current	I_{SINK}	$V_{IN}^+ = 0V, V_{IN}^- = 1V$	10	20	-	mA
Channel Separation	CS	$f=1k\sim 20kHz$ Input Referred	-	120	-	dB
Operating Current	I_{CC}	$R_L = \infty$	-	3	5	mA
Slew Rate	SR		-	1.2	-	V/ μs
Unity Gain Bandwidth	f_T		-	1.2	-	MHz
Total Harmonic Distortion	THD	$f=20kHz, V_O=10V_{PP}$	-	1	-	%

■ TYPICAL CHARACTERISTICS

Open Loop Voltage Gain vs. Frequency

($V^+/V^- = \pm 15V$, $R_L = 2k\Omega$, $T_a = 25^\circ C$)

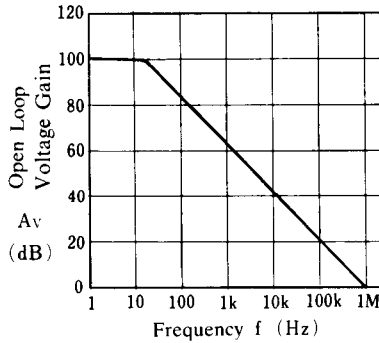

Maximum Output Voltage Swing vs. Frequency

($V^+/V^- = \pm 15V$, $R_L = 2k\Omega$, $T_a = 25^\circ C$)

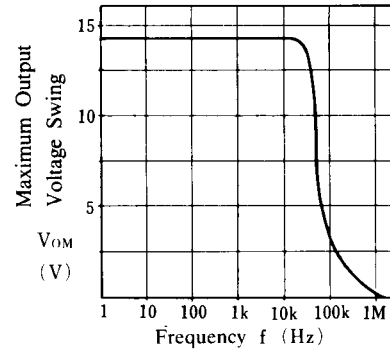

Equivalent Input Noise Voltage vs. Frequency

($V^+/V^- = 15V$, $T_a = 25^\circ C$)

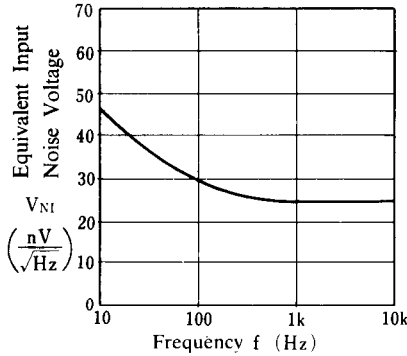

Output Source Current vs. Output Voltage Swing

($V^+/V^- = \pm 15V$, $T_a = 25^\circ C$)

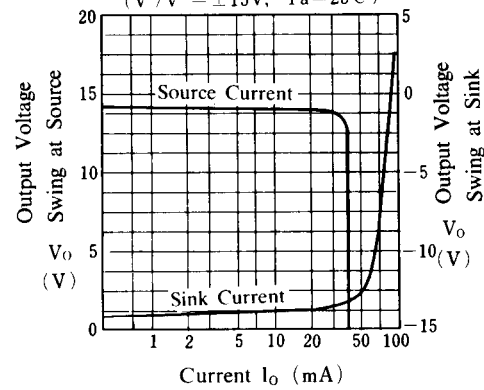

Square Wave Respons

($V^+/V^- = \pm 15V$, $R_L = 2k\Omega$, $A_v = 1$, $T_a = 25^\circ C$)

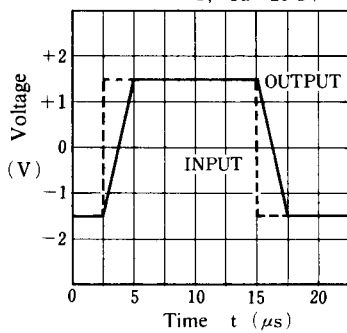

Maximum Output Voltage vs. Load Resistance

($V^+ = 5V$, $T_a = 25^\circ C$)

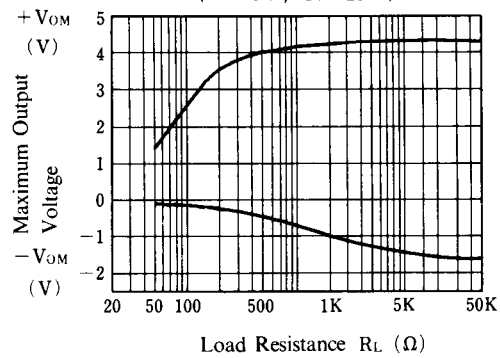

NJM3403A

■ TYPICAL CHARACTERISTICS

Input offset Voltage vs. Temperature

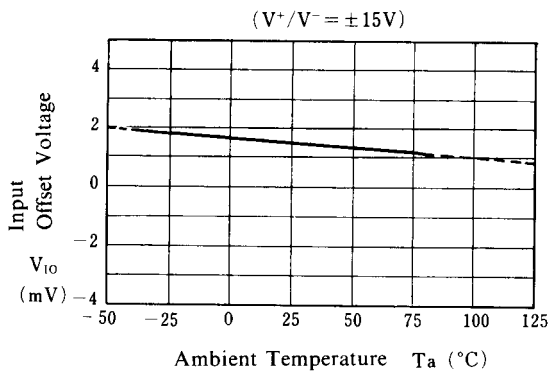

Input Bias Current vs. Temperature

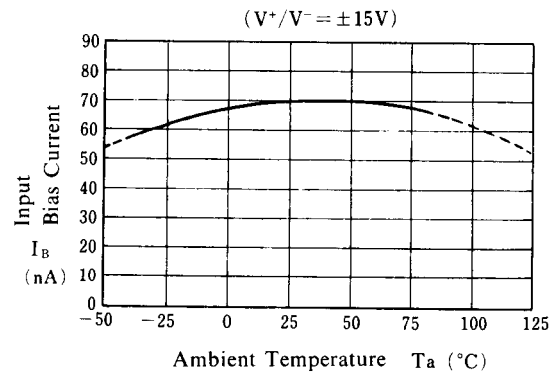

Operating Current vs. Temperature

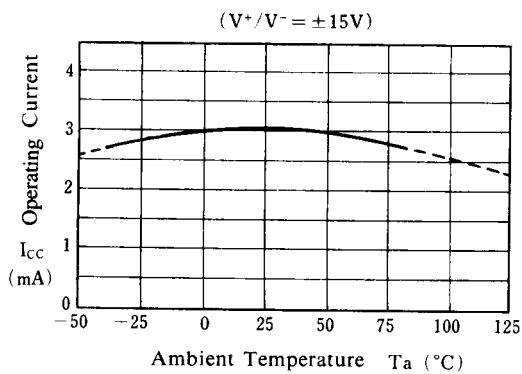

Maximum Output Voltage Swing vs. Temperature

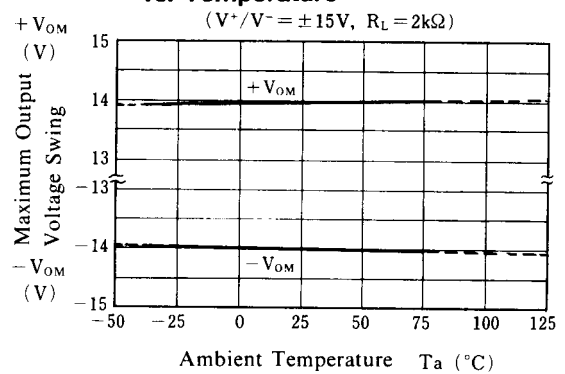

Output Source Current vs. Temperature

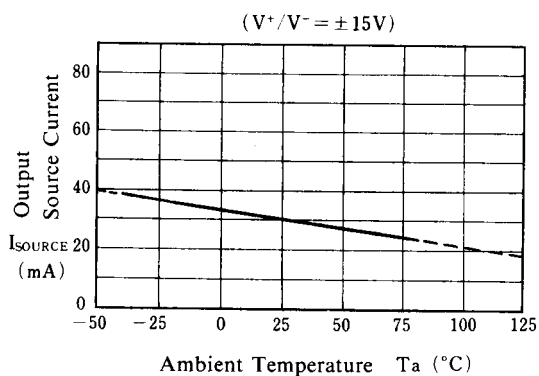

Slew Rate vs. Temperature

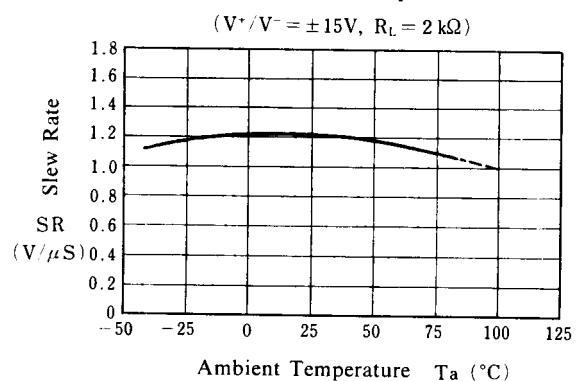

■ TYPICAL CHARACTERISTICS

Operating Current vs. Operating Voltage

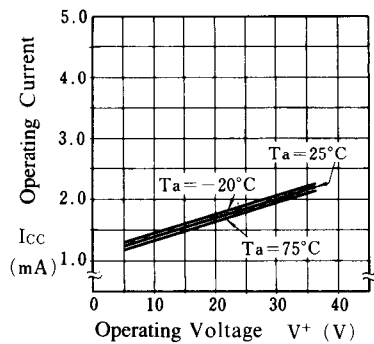

Output Voltage Swing vs. Operating Voltage

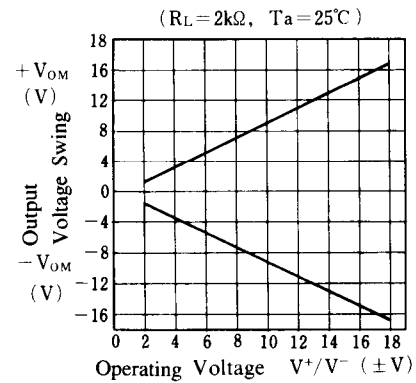

■ Crossover Distortion

Photos (1) and (2) show the output waveforms of NJM3403A and operational amplifier having crossover distortion. The NJM3403A eliminates the crossover distortion through the A,B class output stage as shown in the photo. NJM3403A IC has realized a wide band and a high slew rate in addition to the low distortion.

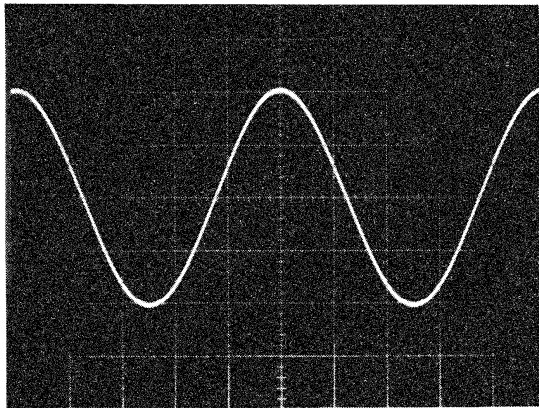

(1) NJM3403A Output Waveform

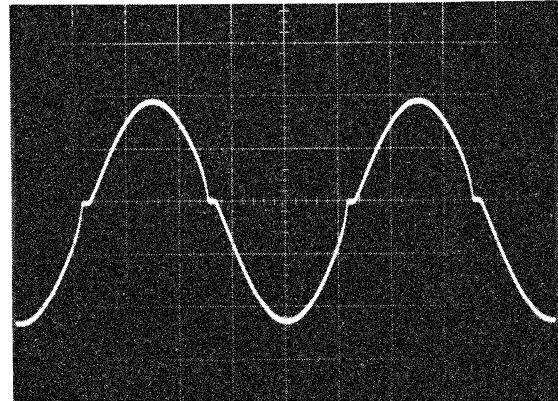

(2) Crossover Distortion Example

$f = 1\text{kHz}$, $R_L = 2\text{k}\Omega$, Vertical Axis: 2V/div

[CAUTION]

The specifications on this databook are only given for information, without any guarantee as regards either mistakes or omissions. The application circuits in this databook are described only to show representative usages of the product and not intended for the guarantee or permission of any right including the industrial rights.

Looking for pricing, stock, or lifecycle information?

Click below to explore more details on WIN SOURCE:

- ⊖ [View NJM3403AM on WIN SOURCE](#)
- ⊖ [NJR Corporation/NJRC Information](#)

Optimize Your Supply Chain with WIN SOURCE Solutions

- ✓ Global Sourcing Solution
- ✓ Obsolete Management
- ✓ Cost Control Management
- ✓ Shortage Management
- ✓ Alternative Solution
- ✓ Excess Inventory Management