

SINGLE-SUPPLY DUAL OPERATIONAL AMPLIFIER

■ GENERAL DESCRIPTION

The NJM3404A is high performance single supply dual operational amplifier. The NJM3404A is a half type of the NJM3403A, quad operational amplifier.

The NJM3404A is improved version of the NJM2904 on slew rate & cross-over distortion.

■ FEATURES

- Single Supply
- Operating Voltage (+4V~+36V)
- Low Operating Current (2.0mA typ.)
- Slew Rate (1.2V/μs typ.)
- Package Outline DIP8, DMP8, SIP8, SSOP8
- Bipolar Technology

■ PACKAGE OUTLINE

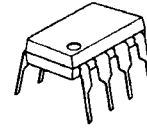

NJM3404AD



NJM3404AM



NJM3404AV

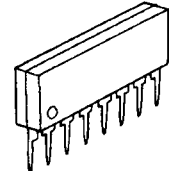

NJM3404AL

■ PIN CONFIGURATION

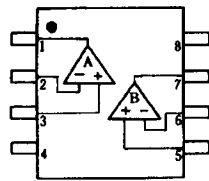

NJM3404AD
NJM3404AM
NJM3404AV

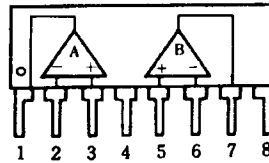

NJM3404AL

- PIN FUNCTION**
- 1.A OUTPUT
 - 2.A -INPUT
 - 3.A +INPUT
 - 4.V⁻
 - 5.B +INPUT
 - 6.B -INPUT
 - 7.B OUTPUT
 - 8.V⁺

■ EQUIVALENT CIRCUIT (1/2 Shown)

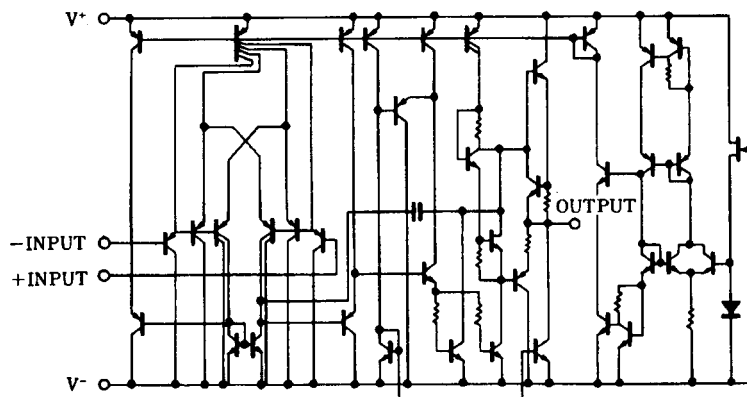

NJM3404A

■ ABSOLUTE MAXIMUM RATINGS

(Ta=25°C)

PARAMETER	SYMBOL	RATINGS	UNIT
Supply Voltage	$V^+(V^-/V)$	36V (or ± 18)	V
Differential Input Voltage	V_{ID}	36	V
Input Voltage	V_{IC}	-0.3~36	V
Power Dissipation	P_D	(DIP8) 500 (DMP8) 300 (SSOP8) 250 (SIP8) 800	mW
Operating Temperature Range	T_{opr}	-40~+85	°C
Storage Temperature Range	T_{stg}	-40~+125	°C

■ ELECTRICAL CHARACTERISTICS

(Ta=25°C, $V^+/V^-=\pm 15V$)

PARAMETER	SYMBOL	TEST CONDITION	MIN.	TYP.	MAX.	UNIT
Input Offset Voltage	V_{IO}	$R_S=0\Omega$	-	2	5	mV
Input Offset Current	I_{IO}		-	5	50	nA
Input Bias Current	I_B		-	70	200	nA
Large Signal Voltage Gain	A_V	$R_L > 2k\Omega$	88	100	-	dB
Maximum Output Voltage Swing	V_{OM}	$R_L = 2k\Omega$	± 13	± 14	-	V
Input Common Mode Voltage Range	V_{ICM}		-15~+13	-	-	V
Common Mode Rejection Ratio	CMR	DC	70	90	-	dB
Supply Voltage Rejection Ratio	SVR		80	94	-	dB
Operating Current	I_{CC}	$R_L = \infty$	-	2.0	3.5	mA
Output Source Current	I_{SOURCE}	$V_{IN}^+ = 1V, V_{IN}^- = 0V$	20	30	-	mA
Output Sink Current	I_{SINK}	$V_{IN}^+ = 0V, V_{IN}^- = 1V$	10	20	-	mA
Slew Rate	SR		-	1.2	-	V/ μs
Unity Gain Bandwidth	f_T	-	-	1.2	-	MHz

■ TYPICAL CHARACTERISTICS

Voltage Gain vs. Frequency

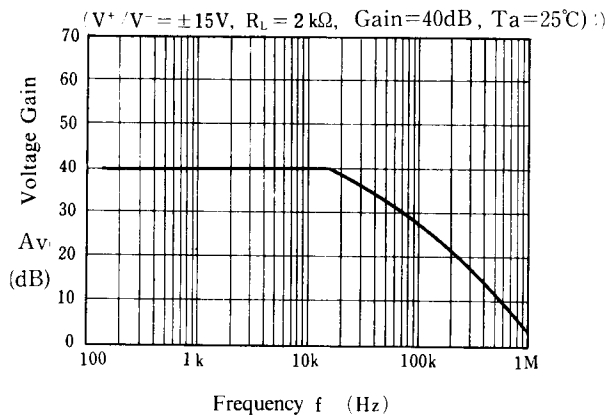

Maximum Output Voltage Swing vs. Load Resistance

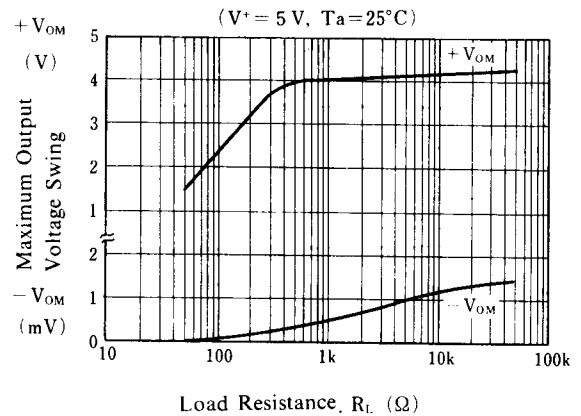

Operating Current vs. Temperature

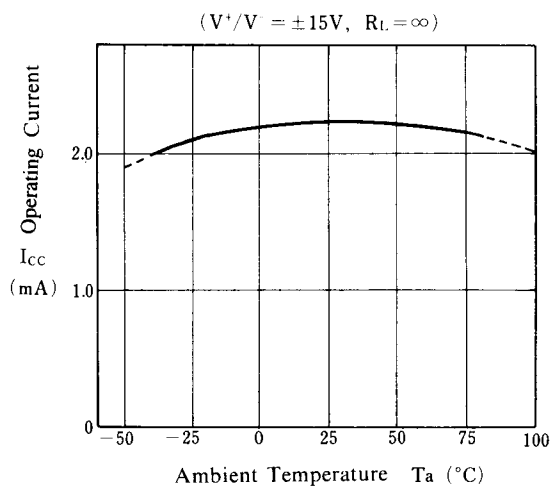

Output Source Current vs. Temperature

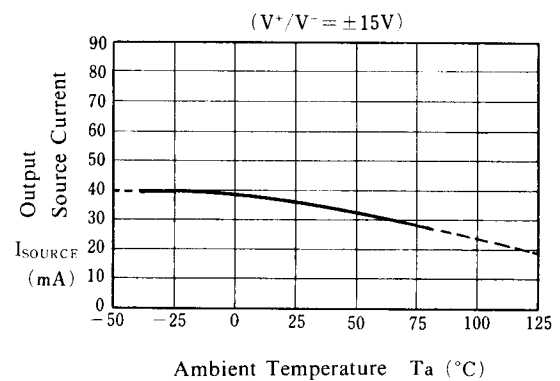

Input Offset Voltage vs. Temperature

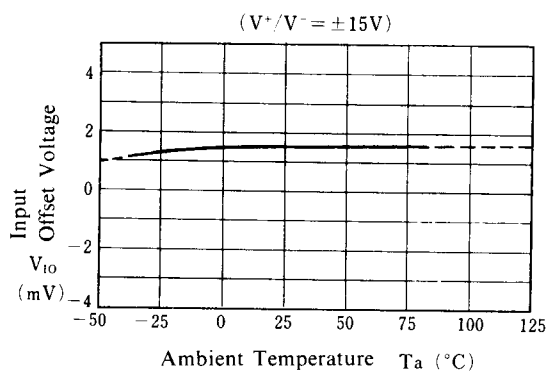

Input Bias Current vs. Temperature

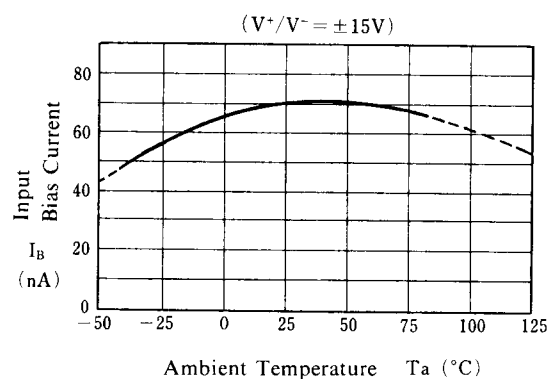

NJM3404A

■ TYPICAL CHARACTERISTICS

**Output Source Current
Output Sink Current
vs. Output Voltage Swing**
($V^+/V^- = \pm 15V$, $T_a = 25^\circ C$)

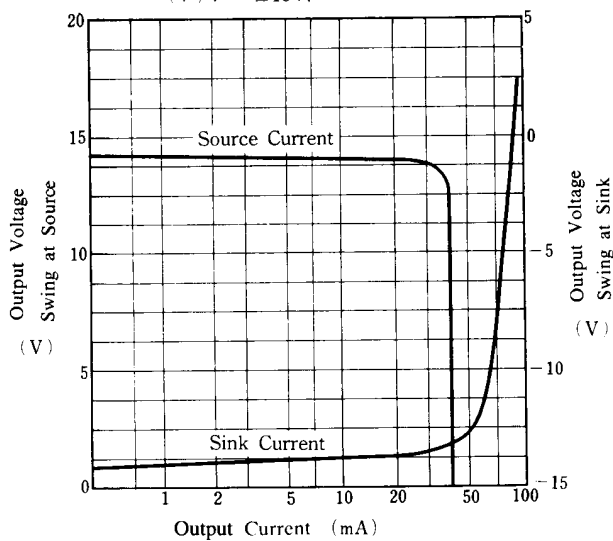

**Operating Current
vs. Operating Voltage**

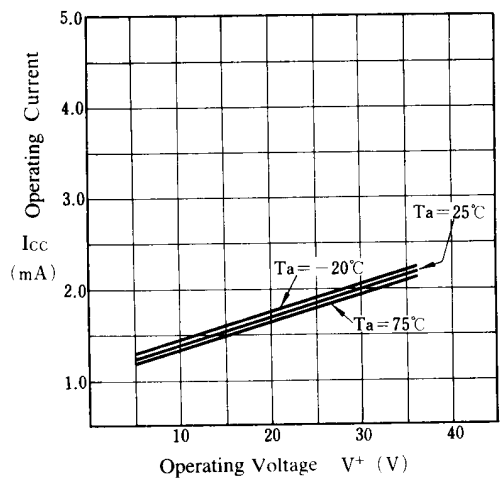

Output Voltage Swing vs. Operating Voltage

($R_L = 2k\Omega$, $T_a = 25^\circ C$)

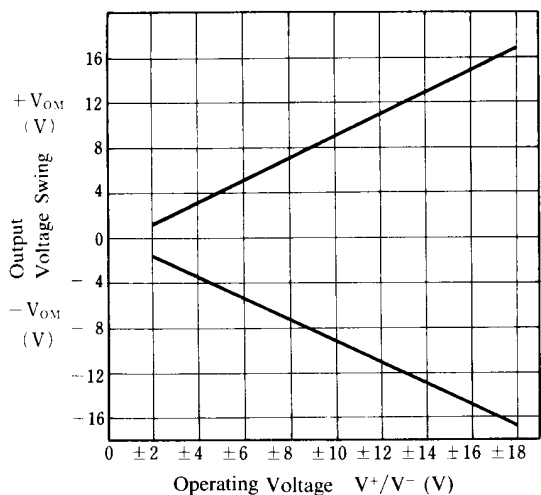

Pulse Response

($V^+/V^- = \pm 15V$, $R_L > 2k\Omega$, $A_v = 1$, $T_a = 25^\circ C$)

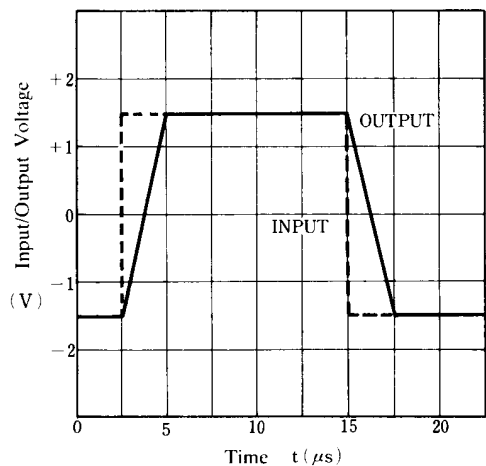

Maximum Output Voltage vs. Frequency

($V^+/V^- = \pm 15V$, $R_L = 2k\Omega$, $T_a = 25^\circ C$)

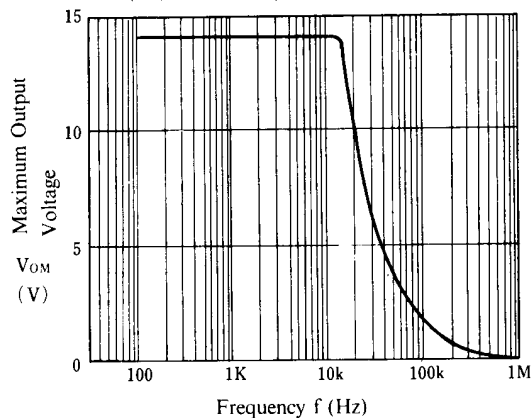

Maximum Output Voltage vs. Temperature

($V^+/V^- = \pm 15V$, $R_L = 2k\Omega$)

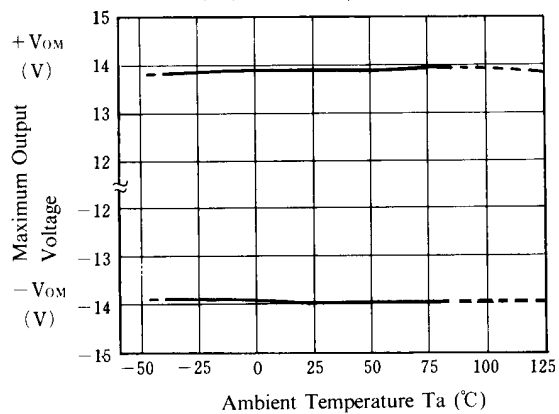

■ TYPICAL APPLICATIONS

Square Wave Oscillator

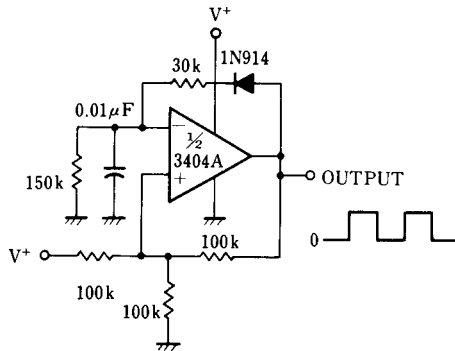

Bandpass Filter

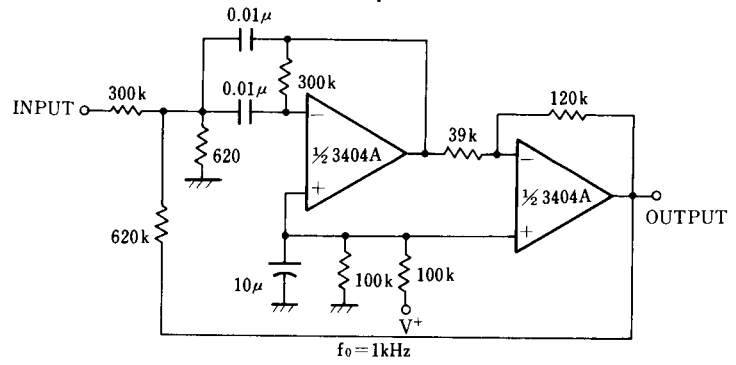



[CAUTION]

The specifications on this databook are only given for information, without any guarantee as regards either mistakes or omissions. The application circuits in this databook are described only to show representative usages of the product and not intended for the guarantee or permission of any right including the industrial rights.

Looking for pricing, stock, or lifecycle information?

Click below to explore more details on WIN SOURCE:

-  [View NJM3404AM on WIN SOURCE](#)
-  [NJR Corporation/NJRC Information](#)

Optimize Your Supply Chain with WIN SOURCE Solutions

-  Global Sourcing Solution
-  Obsolete Management
-  Cost Control Management
-  Shortage Management
-  Alternative Solution
-  Excess Inventory Management