

DUAL OPERATIONAL AMPLIFIER

■ GENERAL DESCRIPTION

The NJM4558 is a dual high-gain operational amplifier with internal compensation circuit and constructed on a single silicon chip. It offers excellent characteristics by combining the parameters adjusted for a monolithic chip. The channel separation characteristic is suitable for measuring instruments.

■ FEATURES

- Operating Voltage ($\pm 4V \sim \pm 18V$)
- High Voltage Gain (100dB typ.)
- High Input Resistance ($5M\Omega$ typ.)
- Bipolar Technology
- Package Outline DIP8, DMP8, SIP8
SOP8 JEDEC 150mil,
SSOP8

■ PACKAGE OUTLINE

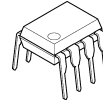

NJM4558D
(DIP8)



NJM4558M
(DMP8)



NJM4558V
(SSOP8)

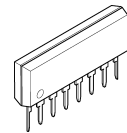

NJM4558L
(SIP8)



NJM4558E
(SOP8)

■ PIN CONFIGURATION

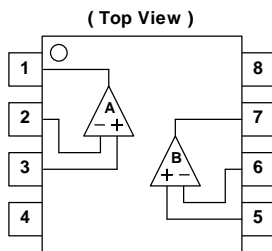

NJM4558D, NJM4558M,
NJM4558E, NJM4558V

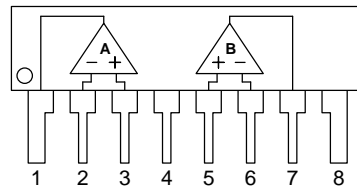

NJM4558L

PIN FUNCTION

1. A OUTPUT
2. A - INPUT
3. A +INPUT
4. V⁻
5. B +INPUT
6. B - INPUT
7. B OUTPUT
8. V⁺

■ EQUIVALENT CIRCUIT (1/2 Shown)

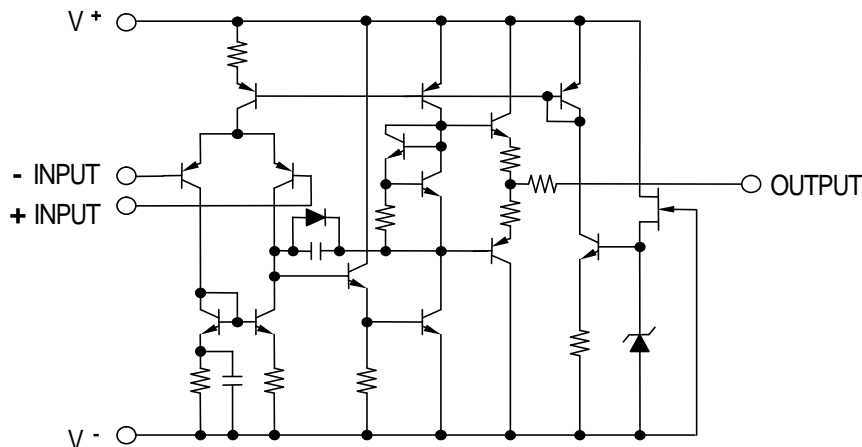

NJM4558

■ ABSOLUTE MAXIMUM RATINGS

(Ta=25°C)

PARAMETER	SYMBOL	RATINGS	UNIT
Supply Voltage	V^+V^-	± 18	V
Differential Input Voltage	V_{ID}	± 30	V
Input Voltage	V_{IC}	± 15 (note1)	V
Power Dissipation	P_D	(DIP8) 500 (DMP8) 300 (SOP8) 300 (SSOP8) 250 (SIP8) 800	mW
Operating Temperature Range	T_{opr}	-40~+85	°C
Storage Temperature Range	T_{stg}	-40~+125	°C

(note1) For supply voltage less than ±15V, the absolute maximum input voltage is equal to the supply voltage.

■ ELECTRICAL CHARACTERISTICS

($V^+V^-=\pm 15V, T_a=25^\circ C$)

PARAMETER	SYMBOL	TEST CONDITION	MIN.	TYP.	MAX.	UNIT
Input Offset Voltage	V_{IO}	$R_S \leq 10k\Omega$	-	0.5	6	mV
Input Offset Current	I_{IO}		-	5	200	nA
Input Bias Current	I_B		-	25	500	nA
Input Resistance	R_{IN}		0.3	5	-	MΩ
Large Signal Voltage Gain	A_V	$R_L \geq 2k\Omega, V_O = \pm 10V$	86	100	-	dB
Maximum Output Voltage Swing 1	V_{OM1}	$R_L \geq 10k\Omega$	± 12	± 14	-	V
Maximum Output Voltage Swing 2	V_{OM2}	$R_L \geq 2k\Omega$	± 10	± 13	-	V
Input Common Mode Voltage Range	V_{ICM}		± 12	14	-	V
Common Mode Rejection Ratio	CMR	$R_S \leq 10k\Omega$	70	90	-	dB
Supply Voltage Rejection Ratio	SVR	$R_S \leq 10k\Omega$	76.5	90	-	dB
Operating Current	I_{CC}		-	3.5	5.7	mA
Slew Rate	SR		-	1	-	V/μs
Equivalent Input Noise Voltage (note2)	V_{NI}	RIAA, $R_S = 2.2k\Omega, 30kHz$ LPF	-	1.4	-	μVrms
Gain Bandwidth Product	GB		-	3	-	MHz

(note2) In regard to Noise Standard, NJRC is preparing for special D Rank type products ($V_{NI}=1.8\mu V$ max.) except for SSOP package.

TYPICAL CHARACTERISTICS

Open Loop Voltage Gain vs. Frequency
 $V^+/V^- = \pm 15V$, $R_L = 2k\Omega$, $T_a = 25^\circ C$

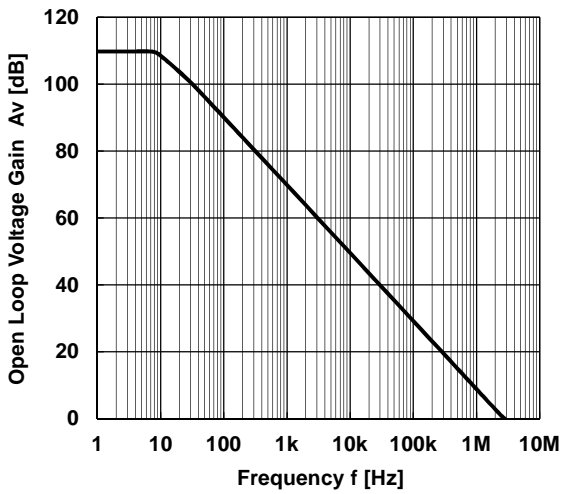

Maximum Output Voltage Swing vs. Frequency
 $V^+/V^- = \pm 15V$, $R_L = 2k\Omega$, $T_a = 25^\circ C$

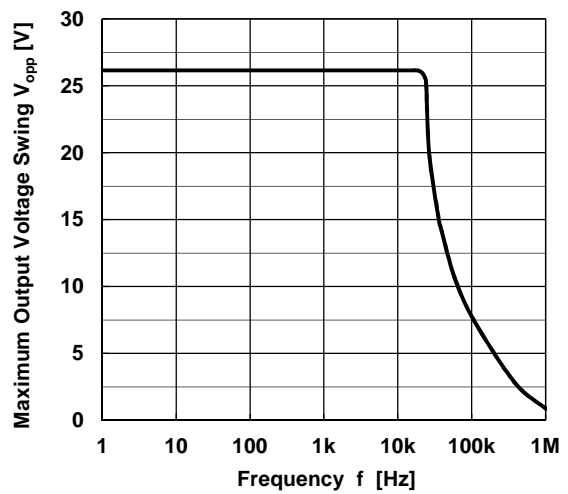

Maximum Output Voltage Swing vs. Load Resistance
 $V^+/V^- = \pm 15V$, $T_a = 25^\circ C$

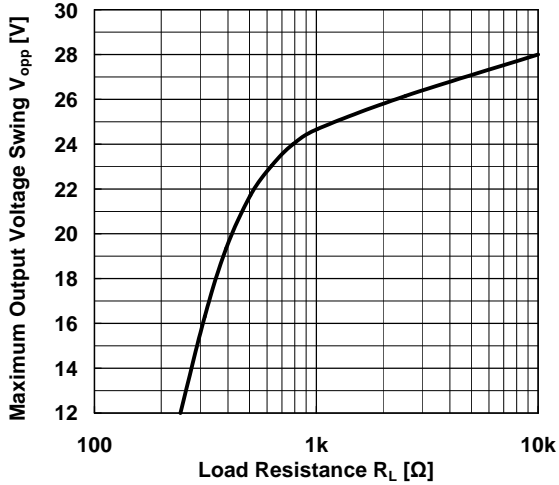

Equivalent Input Noise Voltage vs. Frequency
 $V^+/V^- = \pm 15V$, $R_S = 50\Omega$, $A_v = 60dB$, $T_a = 25^\circ C$

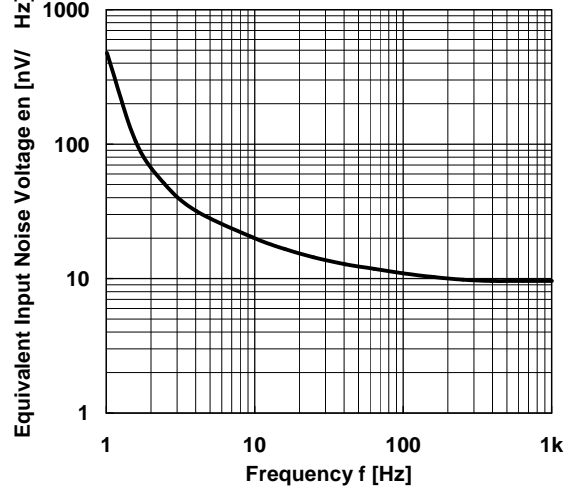

Operating Current vs. Temperature
 $V^+/V^- = \pm 15V$

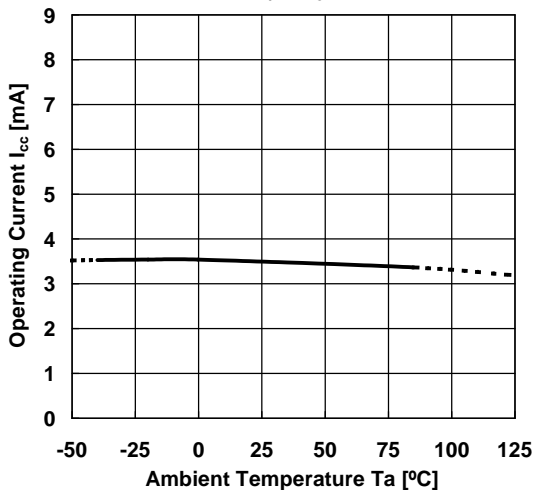

Maximum Output Voltage Swing vs. Temperature
 $V^+/V^- = \pm 15V$, $R_L = 10k\Omega$

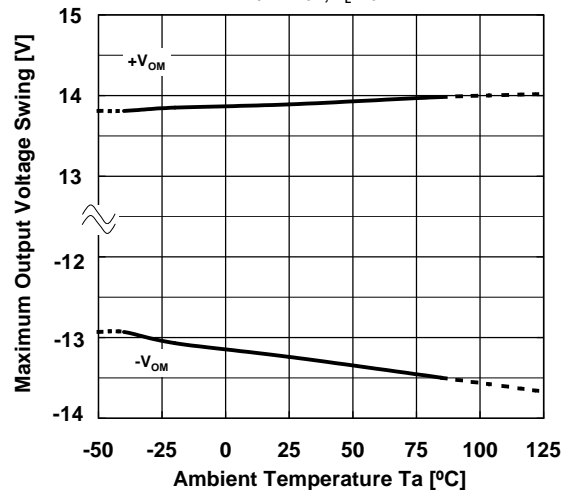

■ TYPICAL CHARACTERISTICS

Input Offset Voltage vs. temperature
 $V^+/V^- = \pm 15V$

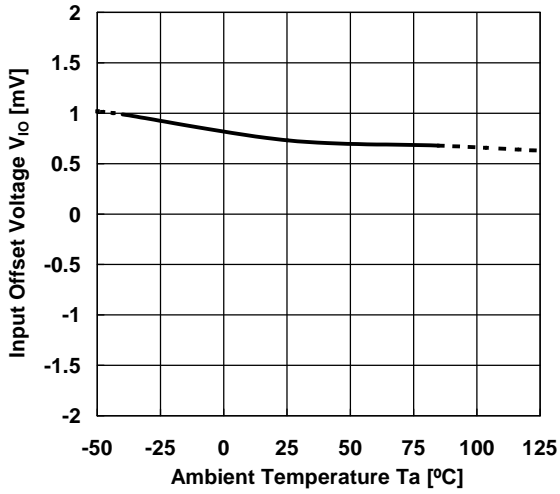

Input Bias Current vs. Temperature
 $V^+/V^- = \pm 15V$

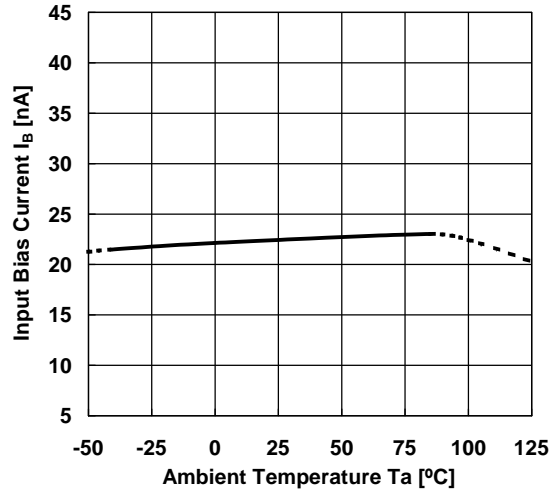

Maximum Output Voltage Swing vs. Operating Voltage
 $R_L = 2k\Omega, T_a = 25^\circ C$

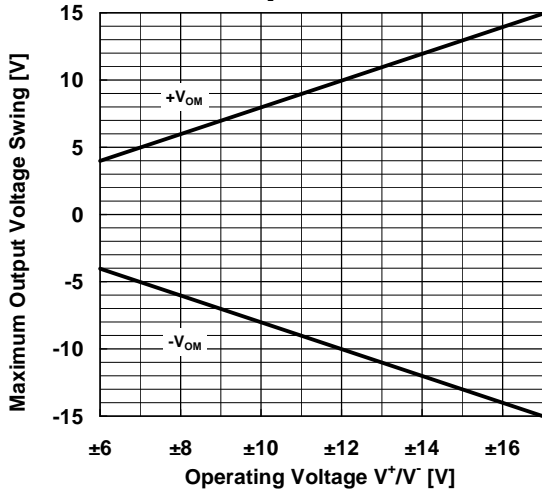

Operating Current vs. Operating Voltage
 $T_a = 25^\circ C$

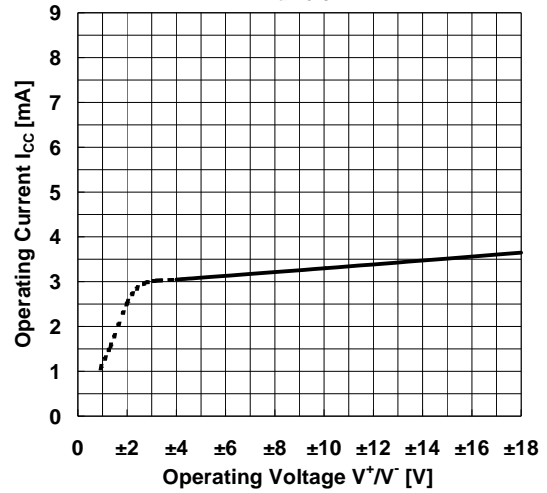



[CAUTION]

The specifications on this databook are only given for information, without any guarantee as regards either mistakes or omissions. The application circuits in this databook are described only to show representative usages of the product and not intended for the guarantee or permission of any right including the industrial rights.

Looking for pricing, stock, or lifecycle information?

Click below to explore more details on WIN SOURCE:

-  [View NJM4558D on WIN SOURCE](#)
-  [NJR Corporation/NJRC Information](#)

Optimize Your Supply Chain with WIN SOURCE Solutions

-  Global Sourcing Solution
-  Obsolete Management
-  Cost Control Management
-  Shortage Management
-  Alternative Solution
-  Excess Inventory Management