



# THE DATASHEET OF NJM4559D



## DUAL OPERATIONAL AMPLIFIER

### ■ GENERAL DESCRIPTION

The NJM4558/4559 integrated circuit is a dual high-gain

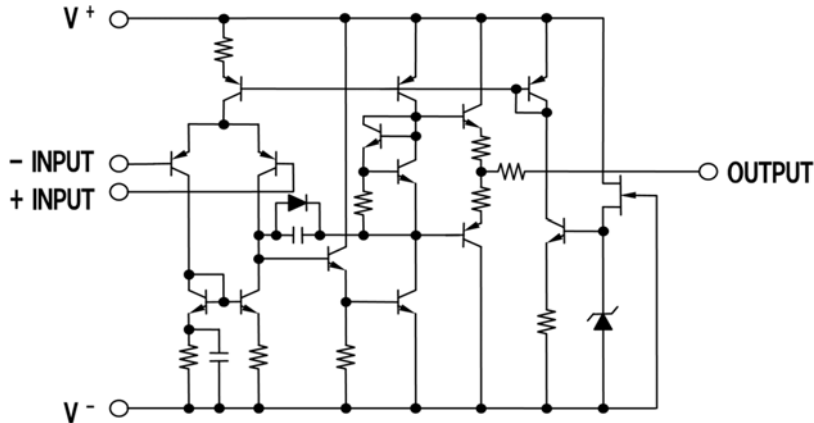

operational amplifier internally compensated and constructed on a single silicon chip using an advanced epitaxial process.

Combining the features of the NJM741 with the close parameter matching and tracking of a dual device on a monolithic chip results in unique performance characteristics. Excellent channel separation allows the use of the dual device in single NJM741 operational amplifier applications providing density. It is especially well suited for applications in differential-in, differential-out as well as in potentiometric amplifiers and where gain and phase matched channels are mandatory.

NJM4558D, NJM4558M,  
 NJM4558E, NJM4558V NJM4558L  
 NJM4559D, NJM4559M NJM4559L

### ■ EQUIVALENT CIRCUIT ( 1/2 Shown )

### ■

- 100dB
- High typ. )
- Bipolar Technology
- Package Outline

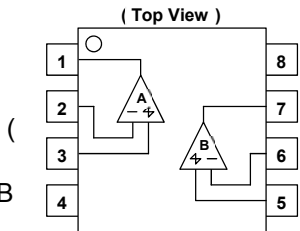

### FEATURES

- Operating Voltage  $\pm 4V \sim \pm 18V$  )
- High Voltage Gain ( typ. )
- Input Resistance (  $5M\Omega$  )

DIP8, DMP8, SIP8

SOP8 JEDEC 150mil (only NJM4558),  
 SSOP8 (only NJM4558)

Ver.2013-11-05

### ■ PIN CONFIGURATION



NJM4558D  
 NJM4559D  
 ( DIP8 )



NJM4558M  
 NJM4559M  
 ( DMP8 )

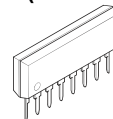

1 2 3 4 5 6 7 8

**NJM4558V**  
( SSOP8 )



**NJM4558L**  
**NJM4559L**  
( SIP8 )

8. V<sup>+</sup>

**NJM4558E**  
( SOP8 )

**PIN FUNCTION**

1. A OUTPUT
2. A - INPUT
3. A +INPUT
4. V<sup>-</sup>
5. B +INPUT
6. B - INPUT
7. B OUTPUT

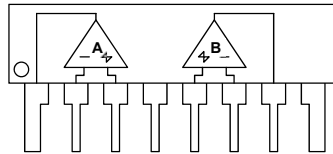

- 1 -

# NJM4558/4559

■ **ABSOLUTE MAXIMUM RATINGS**

( Ta=25°C )

PARAMETER	SYMBOL	RATINGS	UNIT
Supply Voltage	V <sup>+</sup> /V <sup>-</sup>	± 18	V
Differential Input Voltage	V <sub>ID</sub>	± 30	V
Input Voltage	V <sub>IC</sub>	± 15 ( note1 )	V
Power Dissipation	P <sub>D</sub>	( DIP8 ) 500 ( DMP8 ) 300 ( SOP8 ) 300 ( SSOP8 ) 250 ( SIP8 ) 800	mW
Operating Temperature Range	T <sub>opr</sub>	-40~+85	°C
Storage Temperature Range	T <sub>stg</sub>	-40~+125	°C

( note1 ) For supply voltage less than ±15V, the absolute maximum input voltage is equal to the supply voltage.

■ **ELECTRICAL CHARACTERISTICS**

( V<sup>+</sup>/V<sup>-</sup>=±15V, Ta=25°C )

PARAMETER	SYMBOL	TEST CONDITION	MIN.	TYP.	MAX.	UNIT
Input Offset Voltage	V <sub>IO</sub>	R <sub>S</sub> ≤10kΩ	-	0.5	6	mV
Input Offset Current	I <sub>IO</sub>		-	5	200	nA
Input Bias Current	I <sub>B</sub>		-	25	500	nA
Input Resistance	R <sub>IN</sub>		0.3	5	-	MΩ
Large Signal Voltage Gain	A <sub>V</sub>	R <sub>L</sub> ≥2kΩ, V <sub>O</sub> =±10V	86	100	-	dB
Maximum Output Voltage Swing 1	V <sub>OM1</sub>	R <sub>L</sub> ≥10kΩ	± 12	± 14	-	V
Maximum Output Voltage Swing 2	V <sub>OM2</sub>	R <sub>L</sub> ≥2kΩ	± 10	± 13	-	V
Input Common Mode Voltage Range	V <sub>ICM</sub>		± 12	14	-	V
Common Mode Rejection Ratio	CMR	R <sub>S</sub> ≤10kΩ	70	90	-	dB
Supply Voltage Rejection Ratio	SVR	R <sub>S</sub> ≤10kΩ	76.5	90	-	dB
Operating Current	I <sub>CC</sub>		-	3.5	5.7	mA

Slew Rate							
	NJM4558	SR		-	1	-	V/ $\mu$ s
	NJM4559	SR		-	2	-	V/ $\mu$ s
Equivalent Input Noise Voltage (note2)		$V_{NI}$	RIAA, $R_S=2.2k\Omega$ , 30kHz LPF	-	1.4	-	$\mu$ Vrms
Gain Bandwidth Product		GB					
	NJM4558				3		MHz
	NJM4559				6		MHz

(note2) In regard to Noise Standard, NJRC is preparing for special D Rank type products ( $V_{NI}=1.8\mu$ V max.) except for SSOP package.

## ■ TYPICAL CHARACTERISTICS

Open Loop Voltage Gain vs. Frequency

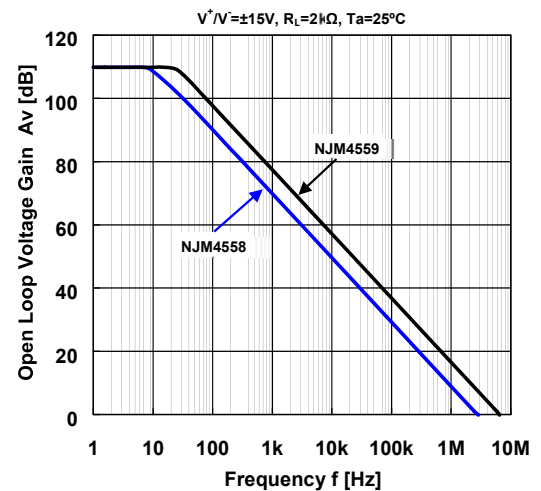

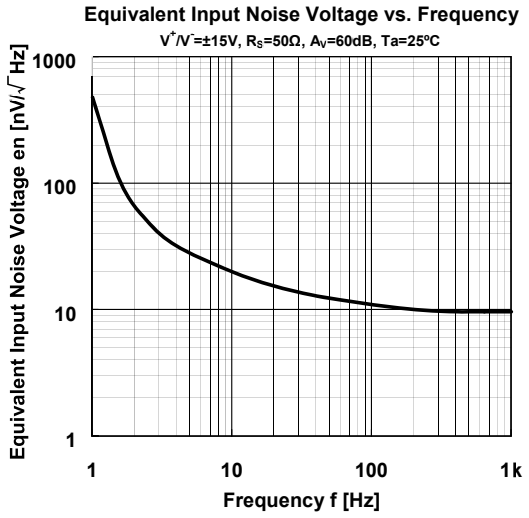
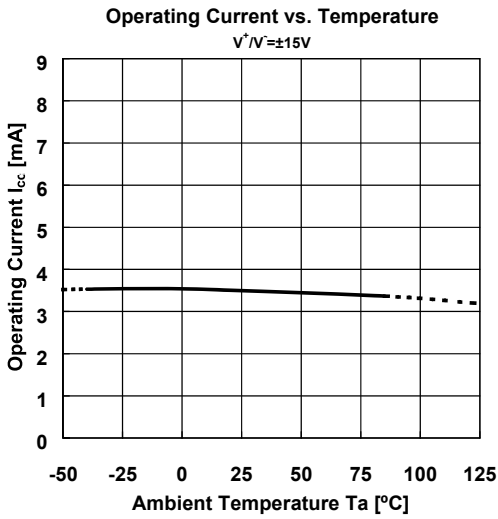
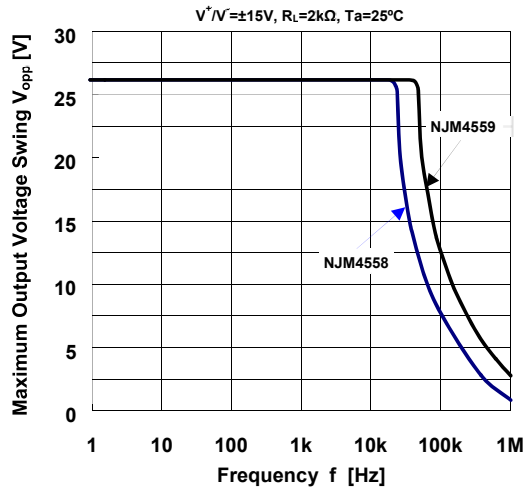
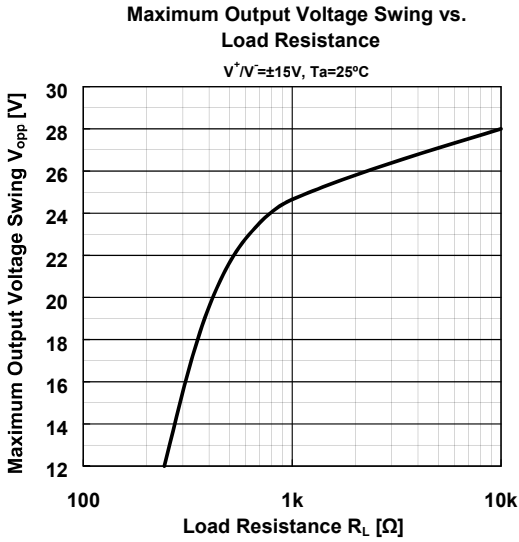

Ver.2013-11-05

# NJM4558/4559

Maximum Output Voltage Swing vs. Frequency

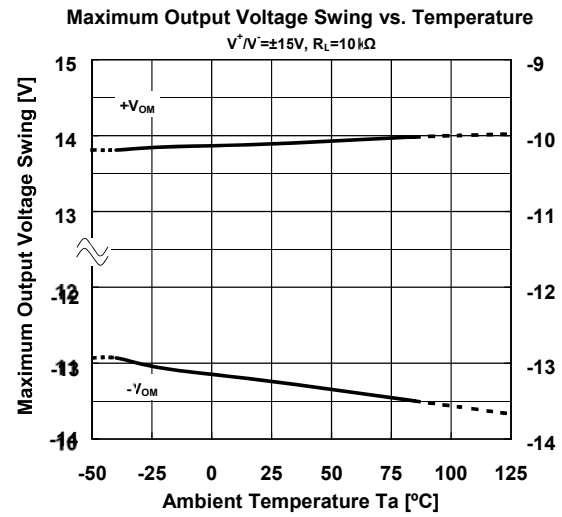

# NJM4558/4559

## TYPICAL CHARACTERISTICS

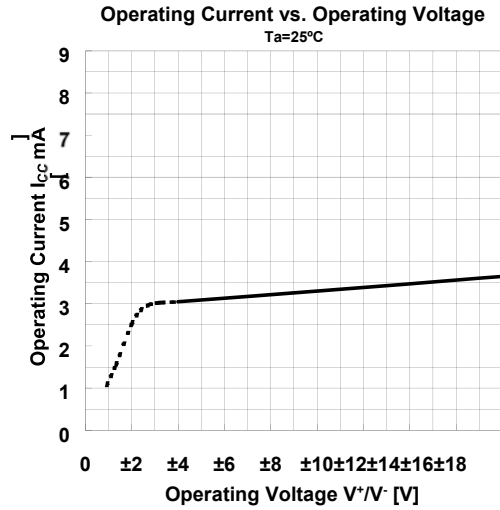
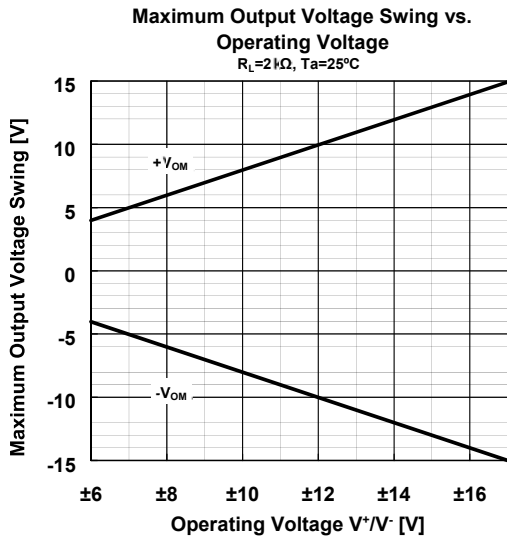
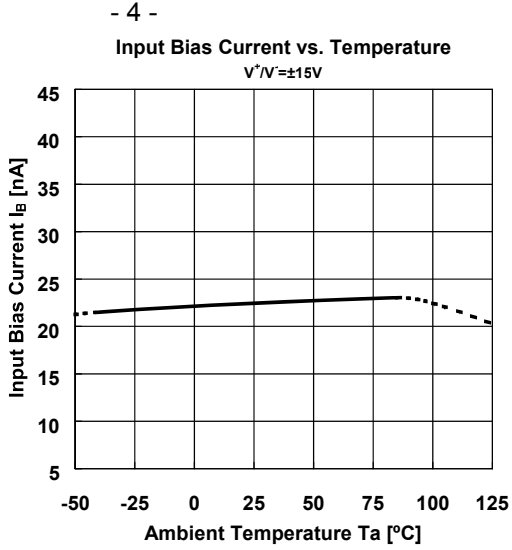
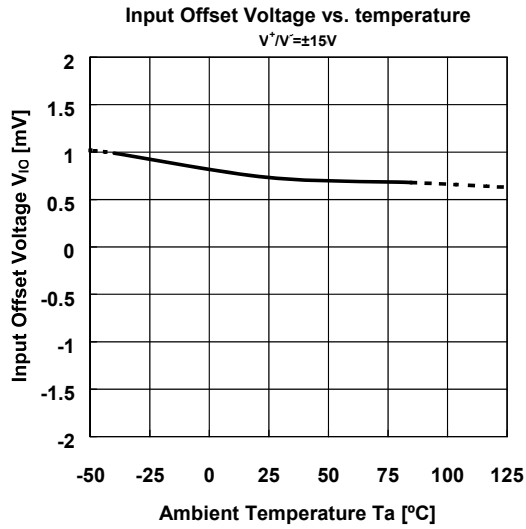

[CAUTION]  
 The specifications on this databook are only given for information, without any guarantee as regards either mistakes or omissions. The application circuits in this databook are described only to show representative usages of the product and not intended for the guarantee or permission of any right including the industrial rights.

## Looking for pricing, stock, or lifecycle information?

Click below to explore more details on WIN SOURCE:

- ⊖ [View NJM4559D on WIN SOURCE](#)
- ⊖ [NJRC Corporation/NJRC Information](#)

## Optimize Your Supply Chain with WIN SOURCE Solutions

- ✓ Global Sourcing Solution
- ✓ Obsolete Management
- ✓ Cost Control Management
- ✓ Shortage Management
- ✓ Alternative Solution
- ✓ Excess Inventory Management