

## LOW-NOISE DUAL OPERATIONAL AMPLIFIER

### ■ GENERAL DESCRIPTION

The NJM5532 is a high performance dual low noise operational amplifier. Compared to the standard dual operational amplifiers, such as the NJM1458, it shows better noise performance, improved output drive capability, and considerably higher small-signal and power bandwidths. It is compensated internally for voltage follower circuit. This makes the device especially suitable for application in high quality and professional audio equipment, instrumentation, control circuits, and telephone channel amplifiers.

If very low noise characteristic is of prime importance, it is recommended D-Rank type products (NJM5532DD/LD/MD). These have specified maximum limits for equivalent input noise voltage.

### ■ PACKAGE OUTLINE

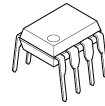

NJM5532D  
(DIP8)

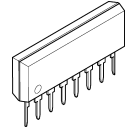

NJM5532L  
(SIP8)



NJM5532M  
(DMP8)

### ■ FEATURES

- Operating Voltage                     $\pm 3V \sim \pm 22V$
- Small Signal Bandwidth            10MHz typ.
- Output Drive Capability            600 $\Omega$ , 10Vrms typ.
- Input Noise Voltage                5nV/ $\sqrt{\text{Hz}}$  typ.
- Power Bandwidth                    140kHz typ.
- Slew Rate                              8V/ $\mu\text{s}$  typ.
- Bipolar Technology
- Package Outline                      DIP8, DMP8, SIP8

### ■ PIN CONFIGURATION

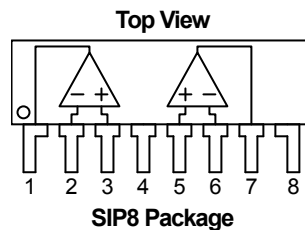
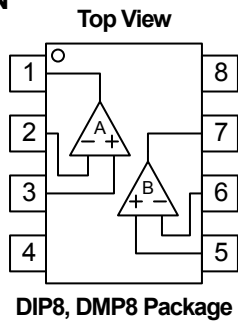

#### PIN FUNCTION

- 1.A OUTPUT
- 2.A -INPUT
- 3.A +INPUT
- 4.V<sup>-</sup>
- 5.B +INPUT
- 6.B -INPUT
- 7.B OUTPUT
- 8.V<sup>+</sup>

### ■ EQUIVALENT CIRCUIT ( 1/2 Shown )

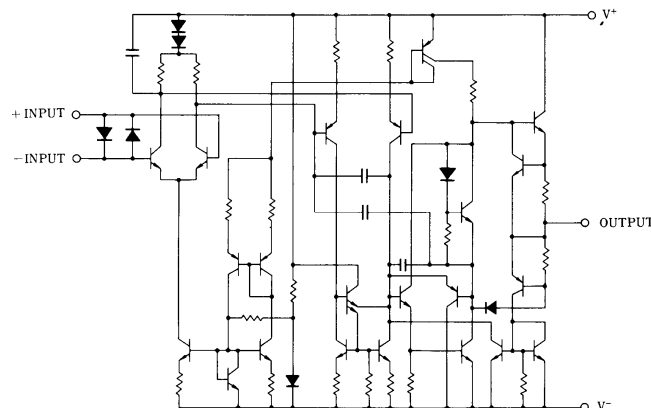

# NJM5532

## ■ ABSOLUTE MAXIMUM RATINGS (Ta=25°C)

PARAMETER	SYMBOL	RATING	UNIT
Supply Voltage	$V^+V^-$	±22	V
Common Mode Input Voltage Range	$V_{ICM}$	$V^+V^-$	V
Differential Input Voltage Range	$V_{ID}$	±0.5	V
Power Dissipation	$P_D$	DIP8 : 500 DMP8 : 600(Note1) SIP8 : 800	mW
Operating Temperature Range	$T_{opr}$	-20~+75	°C
Storage Temperature Range	$T_{stg}$	-40~+125	°C

(Note1) On the cermic PCB (10x20x0.635mm)

## ■ RECOMMENDED OPERATING VOLTAGE (Ta=25°C)

PARAMETER	SYMBOL	RATING	UNIT
Supply Voltage	$V^+V^-$	±3~±22	V

## ■ ELECTRICAL CHARACTERISTICS ( $V^+V^- = \pm 15V$ , Ta=25°C, unless otherwise noted.)

### ● DC ELECTRICAL CHARACTERISTICS

PARAMETER	SYMBOL	TEST CONDITION	MIN.	TYP.	MAX.	UNIT
Input Offset Voltage	$V_{IO}$	$R_S \leq 10k\Omega$	-	0.5	4	mV
Input Offset Current	$I_{IO}$		-	10	150	nA
Input Bias Current	$I_B$		-	200	800	nA
Supply Current	$I_{CC}$	$R_L = \infty$	-	9	16	mA
Common Mode Input Voltage Range	$V_{ICM}$		± 12	± 13	-	V
Common Mode Rejection Ratio	CMR	$R_S \leq 10k\Omega$	70	100	-	dB
Supply Voltage Rejection Ratio	SVR	$R_S \leq 10k\Omega$	80	100	-	dB
Voltage Gain1	$A_{V1}$	$R_L \geq 2k\Omega, V_O = \pm 10V$	88	100	-	dB
Voltage Gain2	$A_{V2}$	$R_L \geq 600\Omega, V_O = \pm 10V$	83.5	94	-	dB
Maximum Output Voltage1	$V_{OM1}$	$R_L \geq 600\Omega$	± 12	± 13	-	V
Maximum Output Voltage2	$V_{OM2}$	$R_L \geq 600\Omega, V^+V^- = \pm 18V$	± 15	± 16	-	V
Input Resistance	$R_{IN}$		30	300	-	kΩ
Short Circuit Output Current	$I_{OS}$		-	38	-	mA

### ● AC ELECTRICAL CHARACTERISTICS

PARAMETER	SYMBOL	TEST CONDITION	MIN.	TYP.	MAX.	UNIT
Output Resistance	$R_O$	$A_V = 30dB, f = 10kHz, R_L = 600\Omega$	-	0.3	-	Ω
Overshoot		$A_V = 1, V_{IN} = 100mV_{PP}, R_L = 100pF, R_L = 600\Omega$	-	10	-	%
Voltage Gain	$A_V$	$f = 10kHz$	-	67	-	dB
Slew Rate	SR		-	8	-	V/μs
Gain Bandwidth Product	GB	$C_L = 100pF, R_L = 600\Omega$	-	10	-	MHz
Power Bandwidth	$W_{PG}$	$V_O = \pm 10V$	-	140	-	kHz
	$W_{PG}$	$V_O = \pm 14V, R_L = 600\Omega, V^+V^- = \pm 18V$	-	100	-	kHz
Equivalent Input Noise Voltage	$e_n$	$f_O = 30Hz$	-	8	-	nV/√Hz
	$e_n$	$f_O = 1kHz$	-	5	-	nV/√Hz
Equivalent Input Noise Current	$i_n$	$f_O = 30Hz$	-	2.7	-	pA/√Hz
	$i_n$	$f_O = 1kHz$	-	0.7	-	pA/√Hz
Channel Separation	CS	$f = 1kHz, R_S = 5k\Omega$	-	110	-	dB

## ■ ELECTRICAL CHARACTERISTICS (D-ranktype(Note2), $V^+V^- = \pm 15V$ , Ta=25°C, unless otherwise noted.)

PARAMETER	SYMBOL	TEST CONDITION	MIN.	TYP.	MAX.	UNIT
Equivalent Input Noise Voltage	$V_{NI}$	RIAA, $R_S = 2.2k\Omega$	-	-	1.4	μVrms

(Note2) D-rank type is a Equivalent Input Noise Voltage selected product.

## ■ TYPICAL CHARACTERISTICS

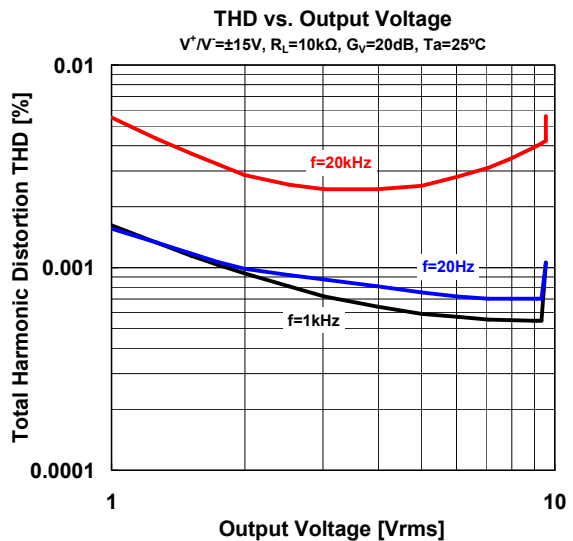
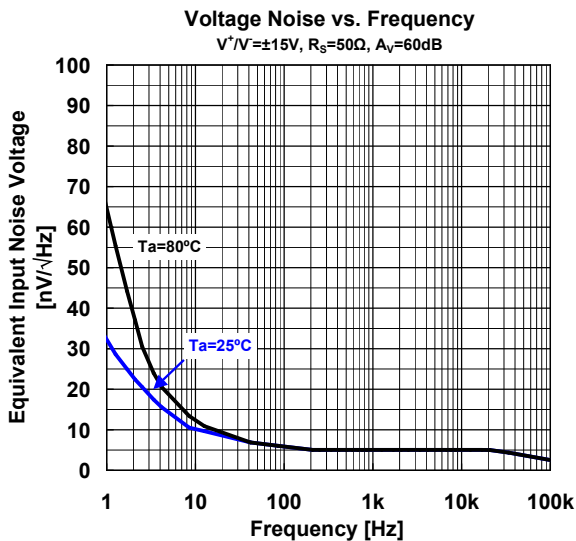
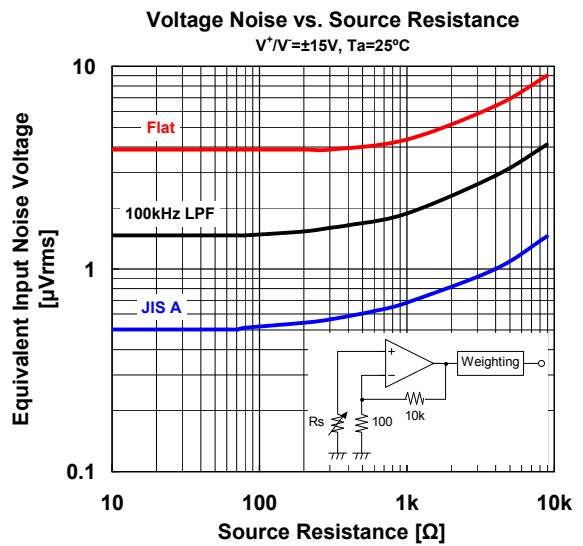
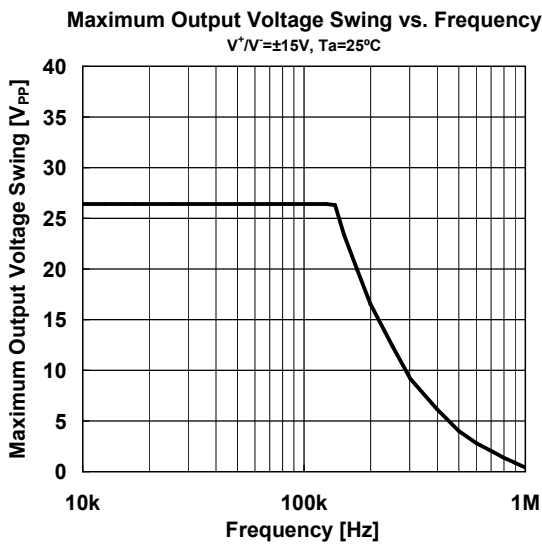
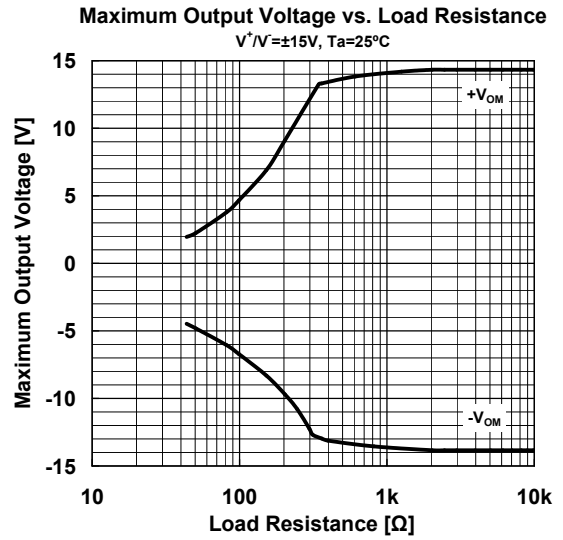
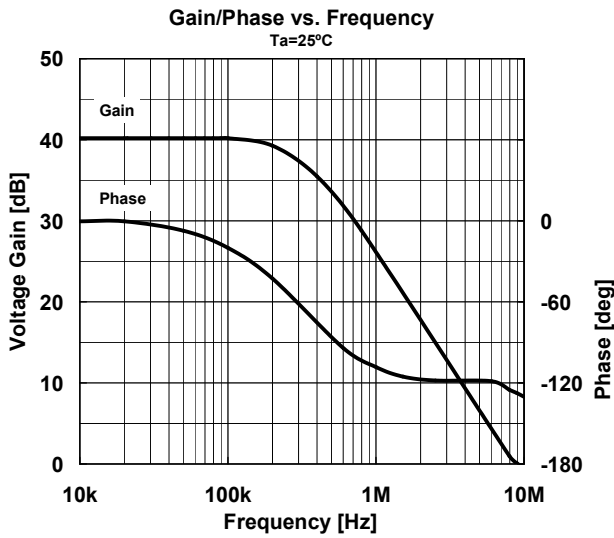

## ■ TYPICAL CHARACTERISTICS

Supply Current vs. Supply Voltage

$T_a=25^\circ\text{C}$

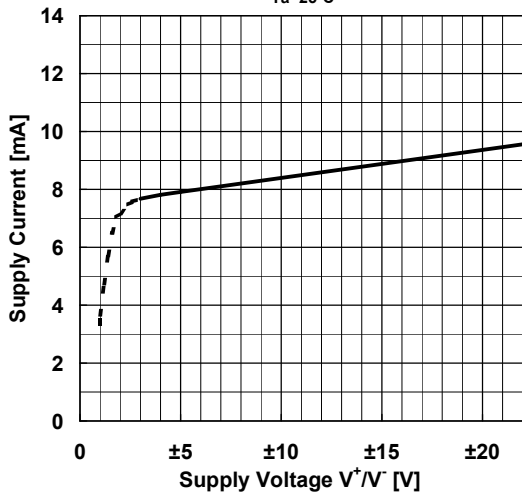

Supply Current vs. Temperature

$V^+/V^-=\pm 15\text{V}$

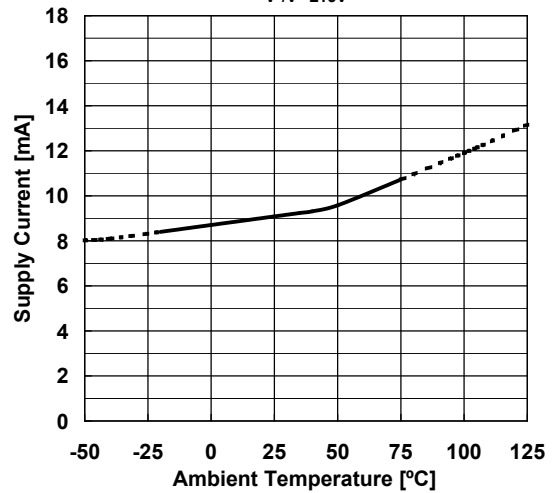

Input Offset Voltage vs. Temperature

$V^+/V^-=\pm 15\text{V}$

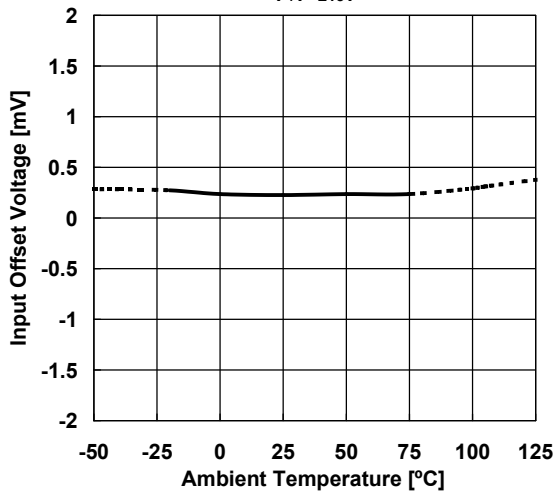

Input Bias Current vs. Temperature

$V^+/V^-=\pm 15\text{V}$

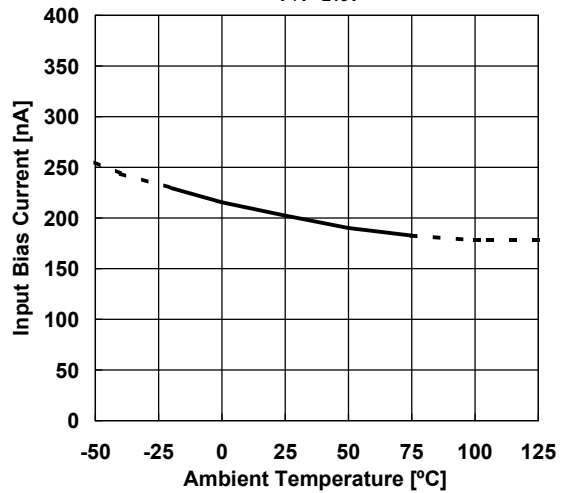

Maximum Output Voltage vs. Supply Voltage

$R_L=2\text{k}\Omega, T_a=25^\circ\text{C}$

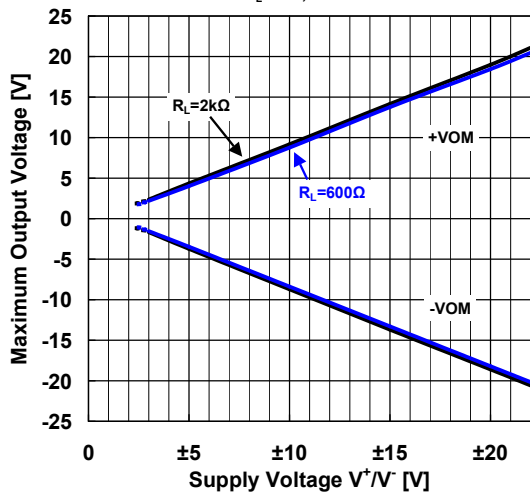

Maximum Output Voltage vs. Temperature

$V^+/V^-=\pm 15\text{V}, R_L=600\Omega$

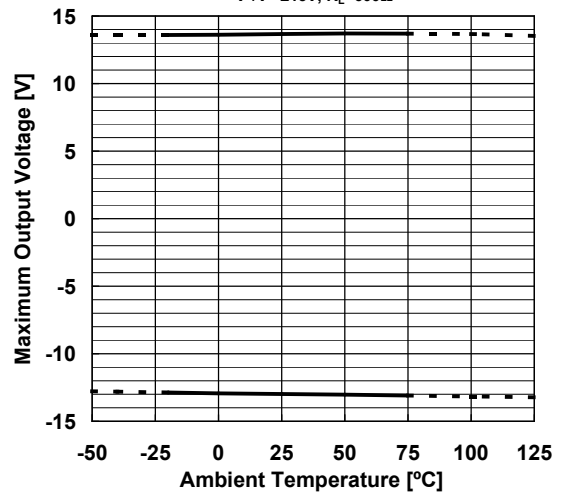

## ■ TEST CIRCUIT

Noise Voltage (RIAA) measurement circuit

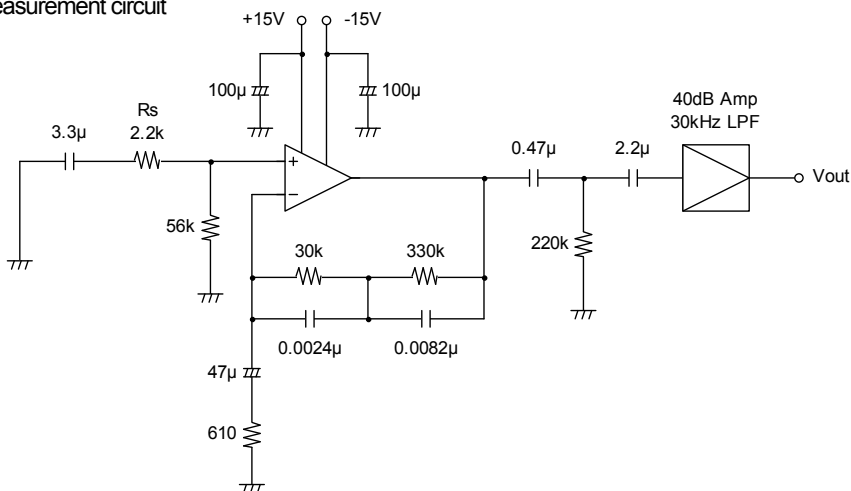

## ■ NOTICE

When used in voltage follower circuit, put a current limit resistor into non-inverting input terminal in order to avoid inside input diode destruction when the power supply is turned on. ( ref.Fig.1 )

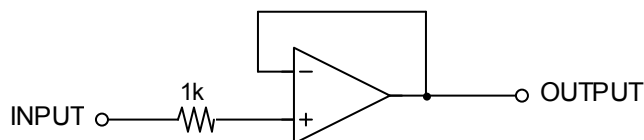



(Fig.1)

**[CAUTION]**

The specifications on this databook are only given for information, without any guarantee as regards either mistakes or omissions. The application circuits in this databook are described only to show representative usages of the product and not intended for the guarantee or permission of any right including the industrial rights.

## Looking for pricing, stock, or lifecycle information?

Click below to explore more details on WIN SOURCE:

-  [View NJM5532M-TE1-3ZZZB on WIN SOURCE](#)
-  [NJR Corporation/NJRC Information](#)

## Optimize Your Supply Chain with WIN SOURCE Solutions

-  Global Sourcing Solution
-  Obsolete Management
-  Cost Control Management
-  Shortage Management
-  Alternative Solution
-  Excess Inventory Management