

NJM78LR05

■ PIN CONFIGURATION

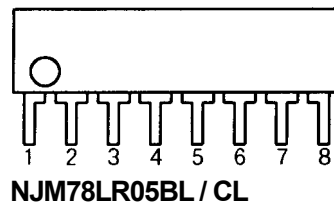

- PIN FUNCTION
1. INPUT
 2. NC
 3. Cd
 4. NC
 5. GND
 6. RESET-OUTPUT
 7. NC
 8. OUTPUT

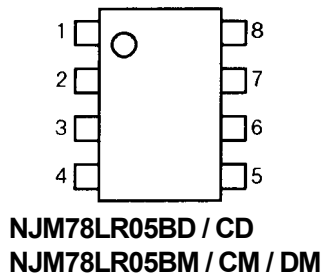
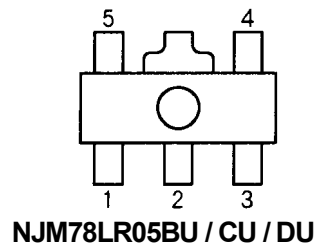

- PIN FUNCTION
1. Cd
 2. GND
 3. RESET-OUTPUT
 4. OUTPUT
 5. INPUT

■ ABSOLUTE MAXIMUM RATINGS

($T_a=25^\circ\text{C}$)

PARAMETER	SYMBOL	MAXIMUM RATINGS	UNIT
Input Voltage	V_{IN}	+20	V
Power Dissipation	P_D	(DIP-8) 500 (DMP8) 500* (SIP8) 800 (SOT-89) 350	mW
Operating Temperature Range	T_{opr}	-40 to +85	$^\circ\text{C}$
Storage Temperature Range	T_{stg}	-50 to +150	$^\circ\text{C}$

*At on PC board.

■ RECOMMENDED OPERATING CONDITIONS

($T_a=25^\circ\text{C}$)

PARAMETER	SYMBOL	CONDITIONS	UNIT
Input Voltage	V_{IN}	7.5 to 18	V
Output Current	I_o	1 to 100	mA

■ ELECTRICAL CHARACTERISTICS

($V_{IN}=10V$, $I_O=40mA$, $C_{IN}=1\mu F$, $C_O=10\mu F$, $T_a=25^\circ C$)

[Power Supply Block]

PARAMETER	SYMBOL	CONDITIONS	MIN.	TYP.	MAX.	UNIT
Output Voltage	V_O	$I_O=1mA$	4.80	5.00	5.20	V
Quiescent Current	I_Q	$I_O=100mA$	-	1.40	3.40	mA
Output Short Current	I_{osc}	OUTPUT-GND short	150	300	450	mA
Line Regulation 1	$\Delta V_O / V_{IN1}$	$7V \leq V_{IN} \leq 18V$	-	6.0	65.0	mV
Line Regulation 2	$\Delta V_O / V_{IN2}$	$8V \leq V_{IN} \leq 18V$	-	3.0	42.0	mV
Load Regulation 1	$\Delta V_O / I_{O1}$	$I_O=1$ to 100mA	-	9.0	60.0	mV
Load Regulation 2	$\Delta V_O / I_{O2}$	$I_O=1$ to 40mA	-	3.0	30.0	mV
Ripple Rejection	RR	$f=120Hz$, $e_{in}=1V_{P-P}$, $V_{IN}=8$ to 18V	-	79	-	dB
Output Noise Voltage	V_{NO}	$10Hz \leq f \leq 100kHz$, $I_O=1mA$	-	80	-	μV
Dropout Voltage	ΔV_{F-O}		-	1.5	2.2	V

[Reset Block]

(H) Reset Output Voltage	V_{ORH}		4.80	5.00	5.20	V
(L) Reset Output Voltage	V_{ORL}	$V_{IN}=3V$, $I_O=1mA$	-	10	200	mV
Reset Threshold Voltage	V_{RT}	B Version	4.12	4.30	4.48	V
		C Version	4.03	4.20	4.37	
		D Version	3.84	4.00	4.16	
Reset Threshold Hysteresis Voltage	V_{RTH}		50	100	200	mV
Reset Output Delay Time	t_d	$C_d=0.1\mu F$	7.50	10.0	12.5	ms

NJM78LR05

APPLICATION CIRCUIT

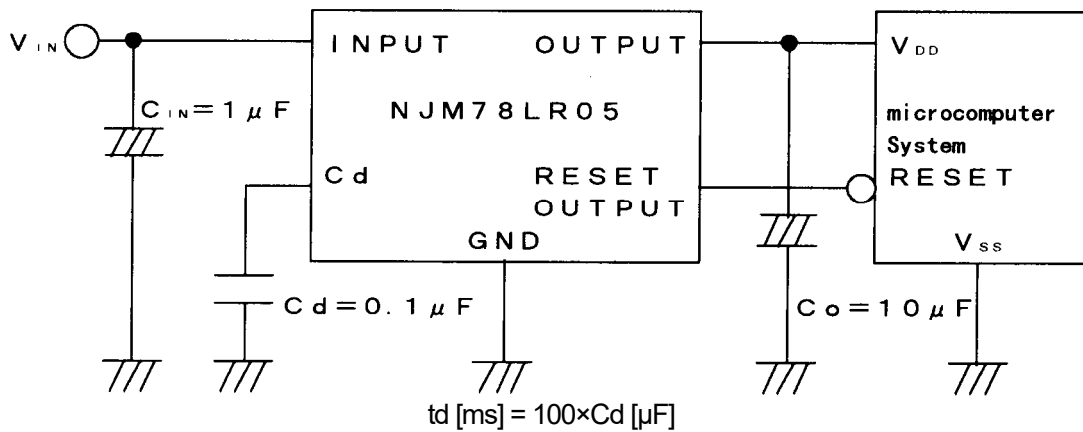

Note 1 : When the capacitance C_d is too large, the actual delay time is shorter than the calculated result because an electrical charge of C_d is discharged incompletely.

Solution of above problem :

- (1) Connect SBD between output terminal and C_d terminal. Please refer to the following circuit.
- (2) Select larger capacitance, C_{IN} than C_d .

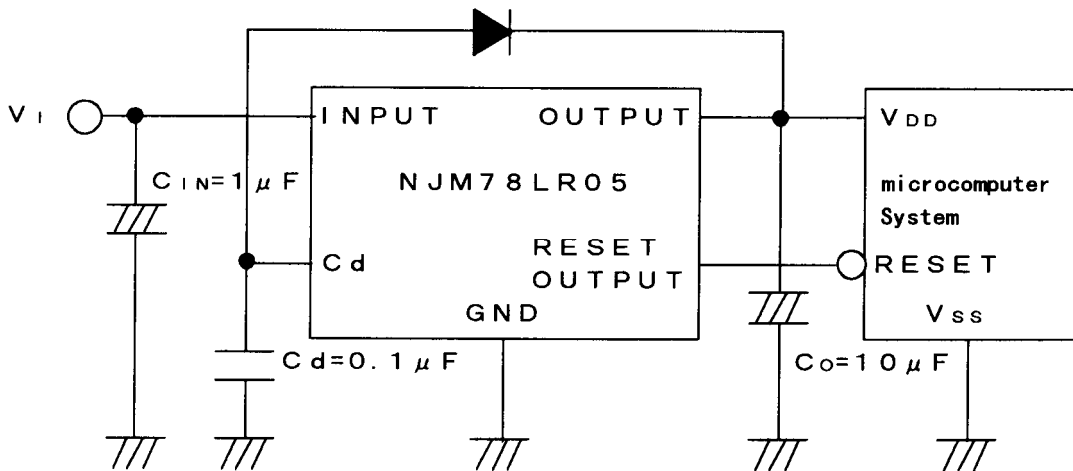

■ TIMING CHART

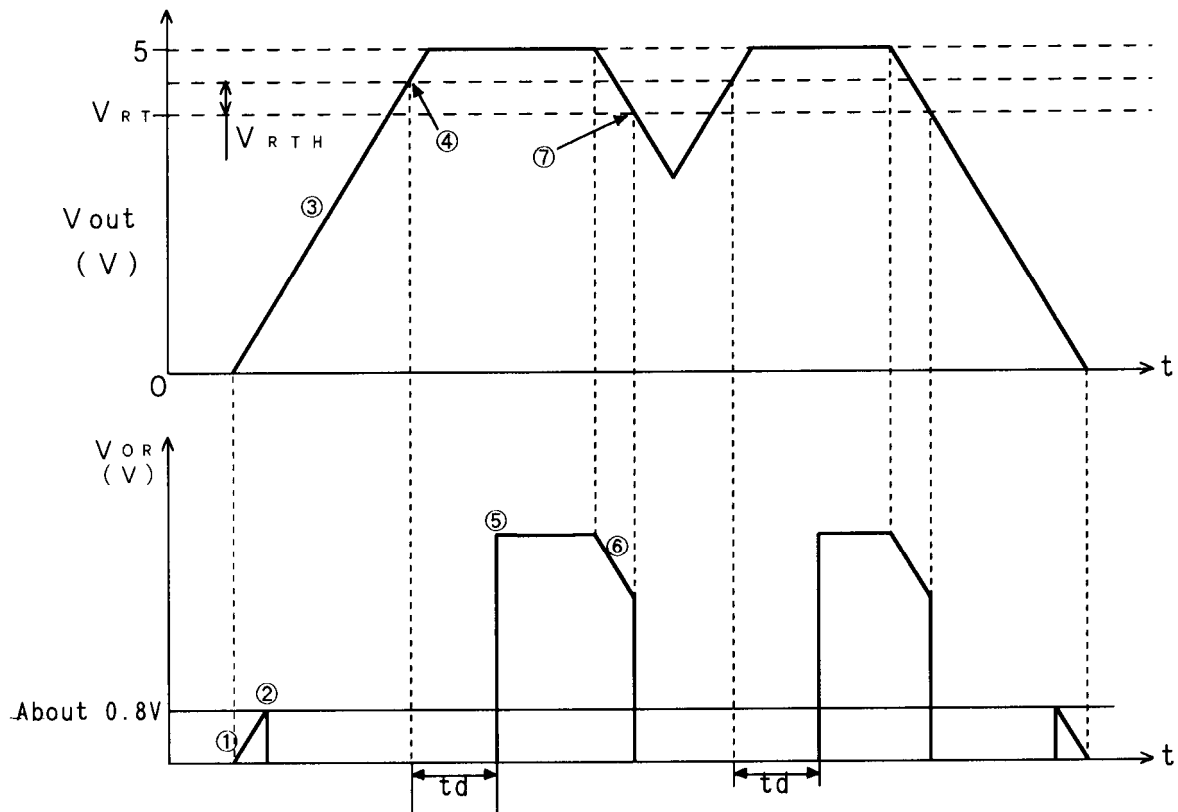

- ①When the input voltage is up to about 0.8V, some voltage is outputted at the reset output because the **NJM78LR05** operation is unstable.
- ②When the input voltage goes over about 0.8V, the reset output becomes "L".
- ③The output voltage is rising up with the input voltage.
- ④When the output voltage goes over ($V_{RT} + V_{RTH}$), the delay circuit of reset output activates.
 V_{RT} : Reset Threshold Voltage
 V_{RTH} : Reset Threshold Hysteresis Voltage
- ⑤After the reset output delay time t_d has passed, the reset output becomes "H".
- ⑥The output voltage is falling down with the input voltage.
- ⑦When the output voltage is less than V_{RT} , the reset output becomes "L".

NJM78LR05

■ TYPICAL CHARACTERISTICS

Reset Output Voltage vs. Output Voltage
($I_O=40\text{mA}, T_a=25^\circ\text{C}$)

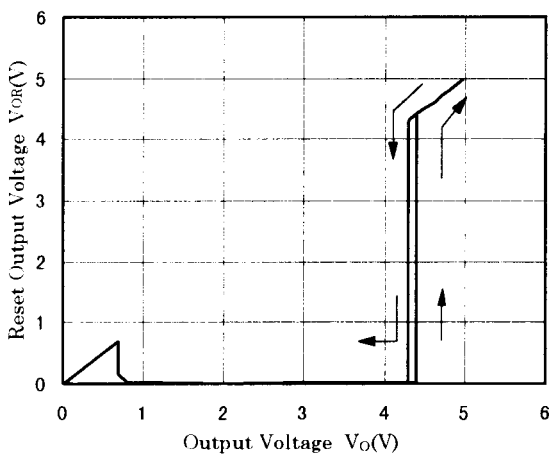

Line Regulation
($T_a=25^\circ\text{C}$)

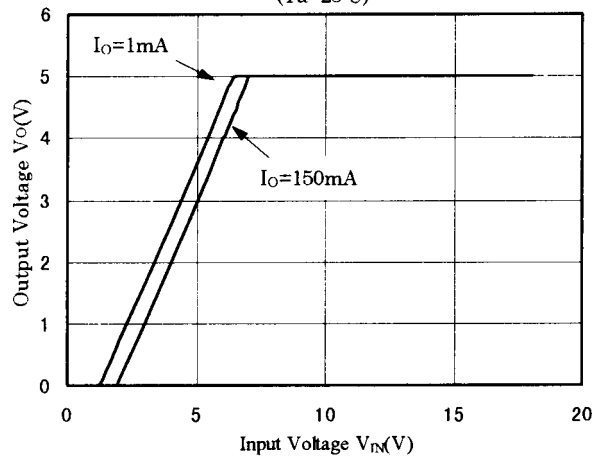

Load Regulation
($V_{IN}=10\text{V}, T_a=25^\circ\text{C}$)

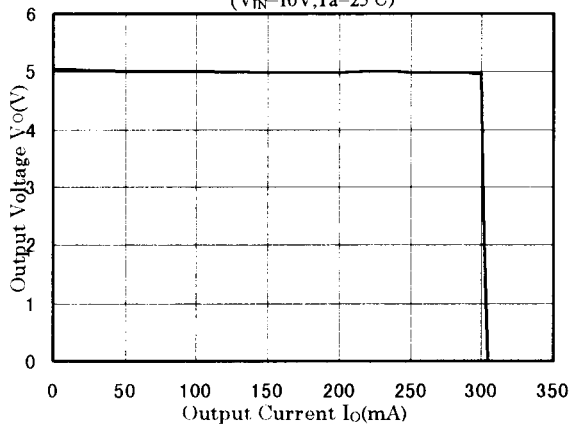

Dropout Voltage
($T_a=25^\circ\text{C}$)

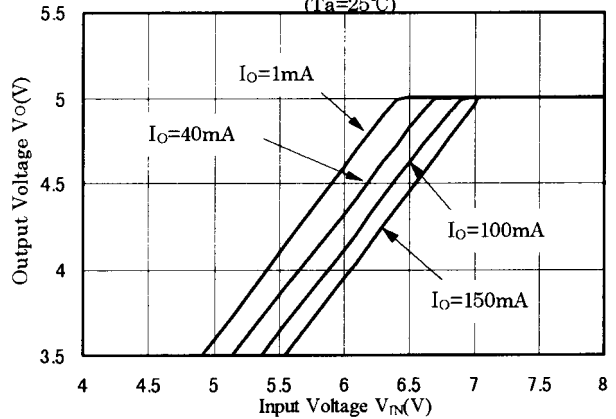

Quiescent Current vs. Input Voltage
($I_O=0\text{mA}, T_a=25^\circ\text{C}$)

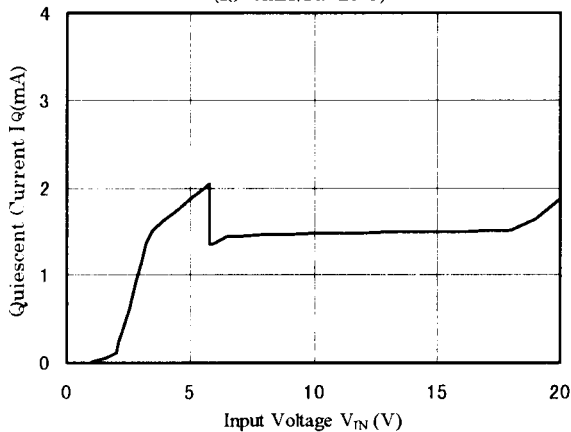

Output Short Current vs. Input Voltage

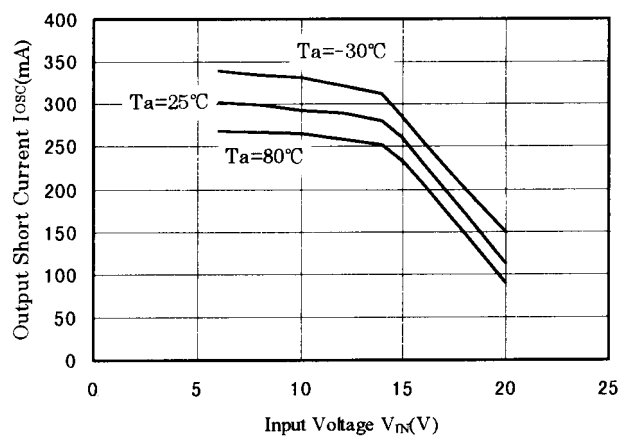

■ TYPICAL CHARACTERISTICS

Reset Output Delay Time vs. Reset Output Delay Capacitance

($V_{IN}=10V, I_O=40mA, T_a=25^\circ C$)

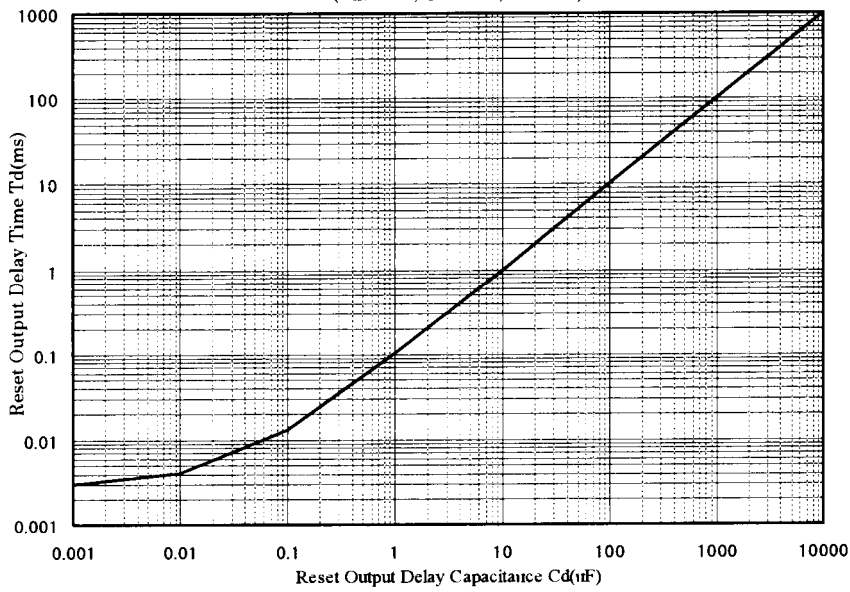

Ripple Rejection vs. Frequency

($V_{IN}=10V, I_O=40mA, \text{crr}=1V_{P-P}, C_O=10\mu F, T_a=25^\circ C$)

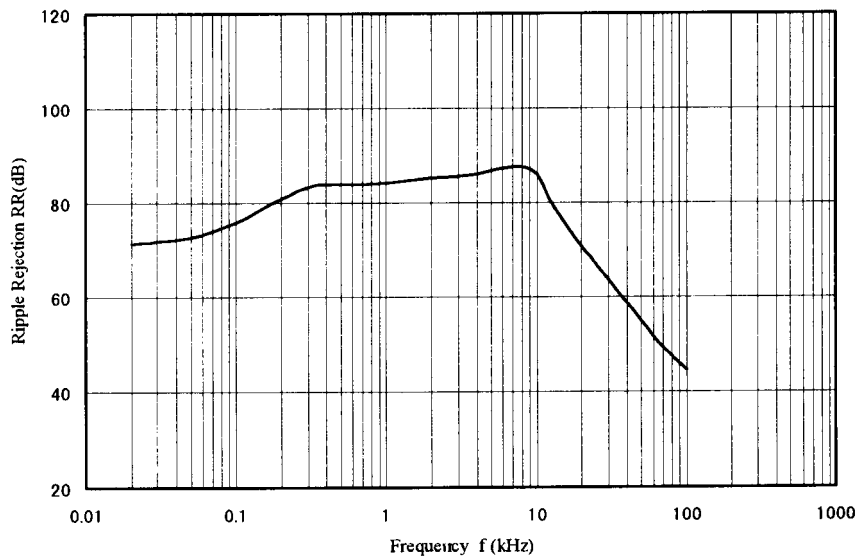

NJM78LR05

■ TYPICAL CHARACTERISTICS

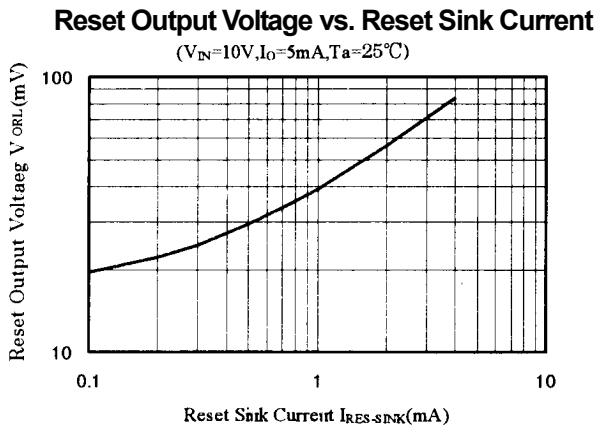
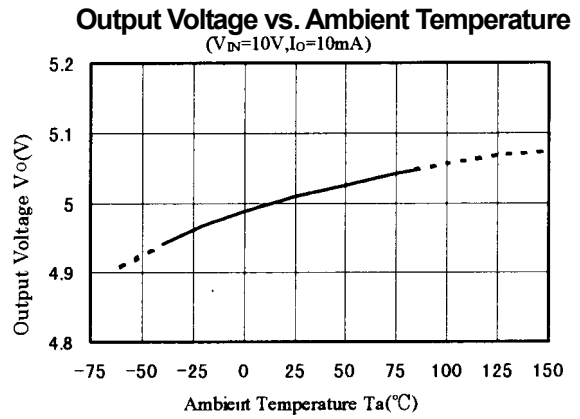
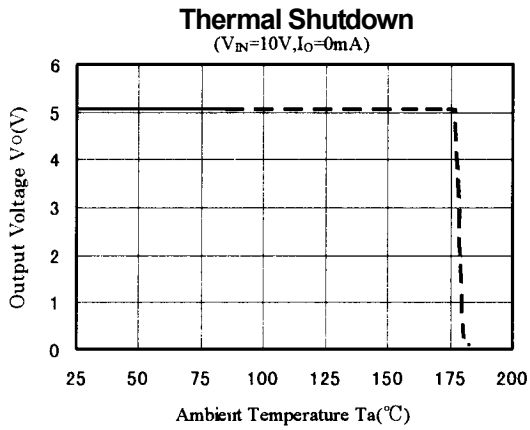



[CAUTION]



The specifications on this databook are only given for information, without any guarantee as regards either mistakes or omissions. The application circuits in this databook are described only to show representative usages of the product and not intended for the guarantee or permission of any right including the industrial rights.

Looking for pricing, stock, or lifecycle information?

Click below to explore more details on WIN SOURCE:

-  [View NJM78LR05BM on WIN SOURCE](#)
-  [NJR Corporation/NJRC Information](#)

Optimize Your Supply Chain with WIN SOURCE Solutions

-  Global Sourcing Solution
-  Obsolete Management
-  Cost Control Management
-  Shortage Management
-  Alternative Solution
-  Excess Inventory Management