

SINGLE 8-CHANNEL MULTIPLEXER
GENERAL DESCRIPTION

The NJU4051B is a single 8-channel multiplexer with three binary control inputs and an inhibit input.

The three binary control input signals select 1 of 8 channels to be turned on, and connect it to the single output.

The operating voltage is as wide as 3 to 18V and the quiescent current is as low as 5 μ A max. (at $V_{DD}=5V$).

It is equivalent to RCA CD4051B and Motorola MC14051B.

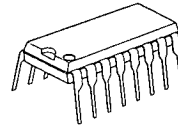
PACKAGE OUTLINE

NJU4051BD

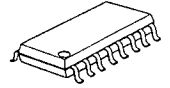

NJU4051BM

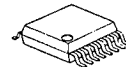

NJU4051BV

FEATURES

- Wide Operating Voltage -- 3 ~ 18V
- Package Outline -- DIP/DMP/SSOP 16
- C-MOS Technology

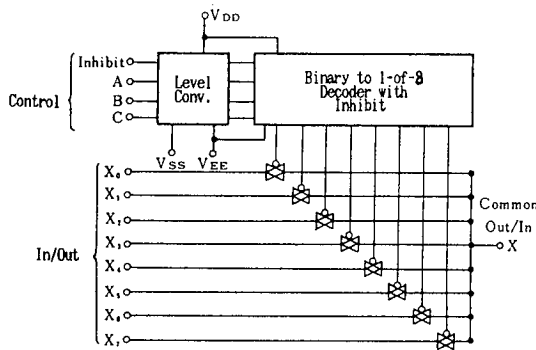
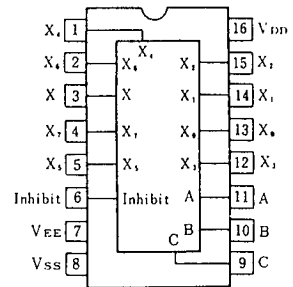
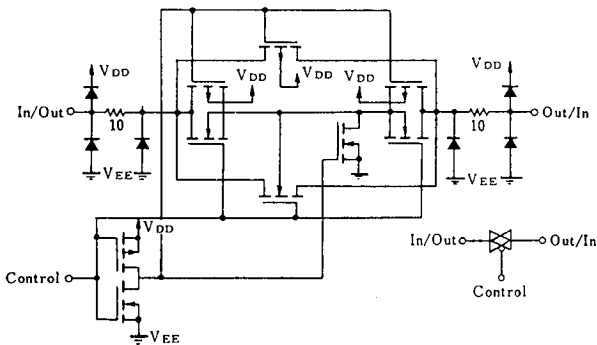
6
BLOCK DIAGRAM

PIN CONFIGURATION

EQUIVALENT CIRCUIT

TRUTH TABLE

INH	C	B	A	ON SW
0	0	0	0	X_0
0	0	0	1	X_1
0	0	1	0	X_2
0	0	1	1	X_3
0	1	0	0	X_4
0	1	0	1	X_5
0	1	1	0	X_6
0	1	1	1	X_7
1	x	x	x	None

x : Don't care

■ ABSOLUTE MAXIMUM RATINGS

(Ta=25°C)

PARAMETER	SYMBOL	RATINGS	UNIT
Supply Voltage	$V_{DD} - V_{SS}$	- 0.5 ~ + 20	V
	$V_{DD} - V_{EE}$	- 0.5 ~ + 20	
Input Voltage	V_{IN}	- 0.5 ~ $V_{DD}+0.5$ *	V
Output Voltage	V_o	- 0.5 ~ $V_{DD}+0.5$ *	V
Input Current	I_{IN}	± 10	mA
Output Current	I_o	± 10	mA
Power Dissipation	P_D	500 (DIP) 200 (DMP) 300 (SSOP)	mW
Operating Temperature Range	T_{opr}	- 40 ~ + 85	°C
Storage Temperature Range	T_{stg}	- 65 ~ + 150	°C

 * $V_{DD}+0.5V$ must be 20V or less.

6
■ ELECTRICAL CHARACTERISTICS

• DC Characteristics

 ($V_{SS}=0V$)

PARAMETER	SYMBOL	CONDITION	V_{DD} (V)	Ta=-40°C		Ta=25°C		Ta=85°C		UNIT
				MIN	MAX	MIN	TYP	MAX	MIN	
Quiescent Current	I_{DD}	No signal, Per Package	5 10 15 20	5 10 20 100	5 10 20 100	5 10 20 100	150 300 600 3000		μA	
On-State Resistance	R_{ON}	$0 \leq V_{i_s} \leq V_{DD}$ $V_{EE}=V_{SS}=0V$	5 10 15	500 210 140	220 100 60	600 250 160	800 300 200		Ω	
On-State Resistance Deviation	ΔR_{ON}	Between 2 channels, $V_{EE}=V_{SS}=0V$	5 10 15		15 10 5				Ω	
Off-Channel Leakage Current		Each channel $V_{EE}=V_{SS}=0V$	18	±1000	±10	±100	±1000		nA	
Input Capacitance	C_{IN}	$V_{IN}=0V$ 1N _H , A, B, C A ₀ to A ₇			5.0 10	7.5			pF	
Low Level Input Voltage	V_{IL}	$R_L=10k\Omega$ $SW=V_{DD}$ $V_{EE}=V_{SS}$	5 10 15	1.5 3.0 4.0	2.25 4.50 6.75	1.5 3.0 4.0	1.5 3.0 4.0		V	
High Level Input Voltage	V_{IH}	$R_L=10k\Omega$ $SW=V_{DD}$ $V_{EE}=V_{SS}$	5 10 15	3.5 7.0 11.0	3.5 7.0 11.0	2.75 5.50 8.25	3.5 7.0 11.0		V	
Input Current	$\pm I_{IN}$	$V_{IN}=0$ or 18V	18	±0.1		±0.1	±1		μA	

SWITCHING CHARACTERISTICS

(Ta=25°C, CL=50pF)

PARAMETER		SYMBOL	CONDITIONS	V _{DD} (V)	MIN	TYP	MAX	UNIT
Propagation Delay Time	SW Input to Output	t _{PLH}	R _L =10kΩ	5	15	45	ns	
		t _{PHL}		10	8	30		
	CONT Input to Output	t _{PLH}		15	5	20		
		t _{PHL}		5	15	45		
Output Enable Time	•	t _{PZH}	R _L =10kΩ	5	600	1400	ns	
		t _{PZL}		10	250	700		
Output Disable Time	•	t _{PHZ}	R _L =10kΩ	5	600	1400	ns	
		t _{PLZ}		10	250	700		
Sine-Wave Distortion			R _i =10kΩ, f=1kHz, V _{is} =5V _{P-P}	10	0.05		%	
Feedthrough(all-ch. off)			R _i =1kΩ, 20log ₁₀ V _{os} /V _{is} =-50dB	10	4.5		MHz	
Crosstalk	SW A and B		R _i =1kΩ, V _{is} =1/2 · (V _{DD} -V _{SS}) _{P-P} , 20log ₁₀ V _{os(B)} /V _{is(A)} =-50dB	10	3.0		MHz	
	Control and Out		R _i =1kΩ, R _L =10kΩ, CONTROL/INHIBIT tr=tf=20ns	10	30		mV	

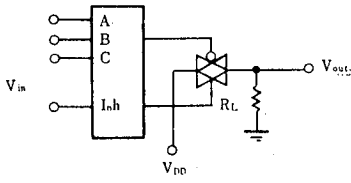
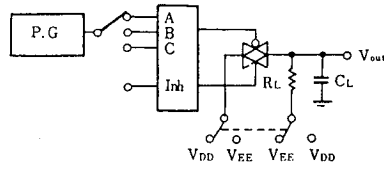
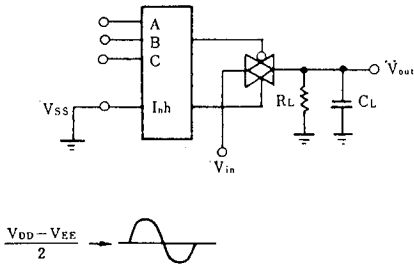
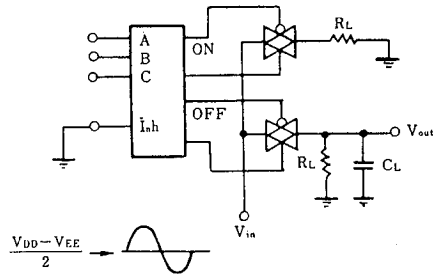
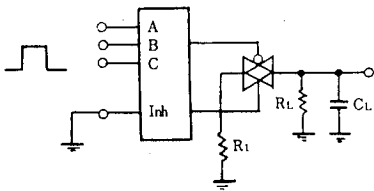
MEASUREMENT CIRCUITS
1. Noise Margin

2. Propagation Delay

3. Feedthrough

4. Crosstalk (Switch A and B)

5. Crosstalk (Control and Out)



MEMO

[CAUTION]





The specifications on this databook are only given for information, without any guarantee as regards either mistakes or omissions. The application circuits in this databook are described only to show representative usages of the product and not intended for the guarantee or permission of any right including the industrial rights.

Looking for pricing, stock, or lifecycle information?

Click below to explore more details on WIN SOURCE:

-  [View NJU4051BM on WIN SOURCE](#)
-  [NJRC Corporation/NJRC Information](#)

Optimize Your Supply Chain with WIN SOURCE Solutions

-  Global Sourcing Solution
-  Obsolete Management
-  Cost Control Management
-  Shortage Management
-  Alternative Solution
-  Excess Inventory Management