

C-MOS QUAD ANALOG SWITCH

■ GENERAL DESCRIPTION

The NJU4066B is a quad bilateral analog switches, which are controlled by independent control signals. The analog switch is ON during the control signal is "H", and OFF during it is "L". The low on-state resistance and superior transfer characteristics permit input of wide voltage range, consequently it is suitable for analog and digital signal switching, chopper-modulator-demodulator and others. The NJU4066B is functionally and pin-to-pin compatible with RCA CD4066B and Motorola MC14066B.

■ PACKAGE OUTLINE

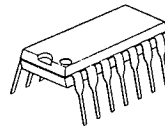

NJU4066BD

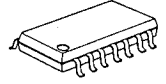

NJU4066BM



NJU4066BV

6

■ FEATURES

- 4 Independent Bilateral Analog Switches
- Low On-state Resistance
- Package Outline -- DIP/DMP/SSOP 14
- C-MOS Technology

■ TERMINAL DESCRIPTION

NO.	SYMBOL	FUNCTION
13,5,6,12	A,B,C,D	Control Inputs
1,2,3,4 8,9,10,11	IN/OUT (OUT/IN)	Signal Input/Output (Output/Input)
14	V _{DD}	Power Supply
7	V _{SS}	Ground

■ PIN CONFIGURATION

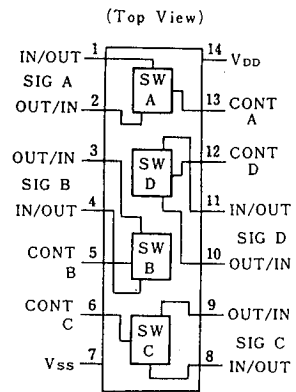

■ EQUIVALENT CIRCUIT

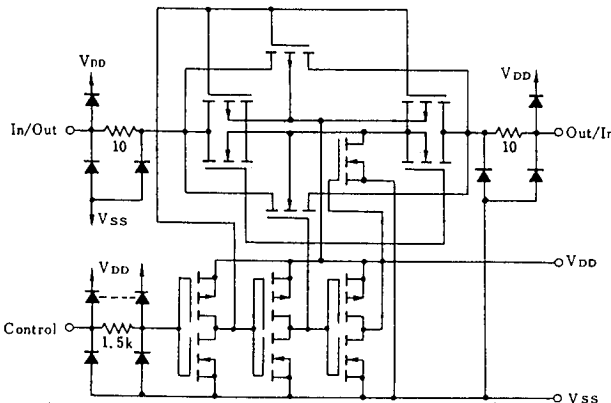

■ TRUTH TABLE

Control Signal	Switch
V _{DD} (1)	ON
V _{SS} (0)	OFF

■ ABSOLUTE MAXIMUM RATINGS

(Ta=25°C)

PARAMETER	SYMBOL	RATINGS	UNIT
Supply Voltage	V _{DD}	- 0.5 ~ +20	V
Input Voltage	V _{IN}	- 0.5 ~ V _{DD} +0.5 *	V
Output Voltage	V _O	- 0.5 ~ V _{DD} +0.5 *	V
Input Current	I _{IN}	± 10	mA
Output Current	I _O	± 10	mA
Power Dissipation	P _D	500 (DIP) 200 (DMP) 300 (SSOP)	mW
		100 (Per Gate)	
Operating Temperature	Topr	- 40 ~ + 85	°C
Storage Temperature	Tstg	- 60 ~ + 150	°C

 * V_{DD}+0.5V must be 20V or less.

■ ELECTRICAL CHARACTERISTICS

• DC Characteristics

 (V_{SS}=0V)

PARAMETER	SYMBOL	CONDITIONS	V _{DD} (V)	Ta=-40°C		Ta=25°C			Ta=85°C		UNIT
				MIN	MAX	MIN	TYP	MAX	MIN	MAX	
Quiescent Current	I _{DD}	V _{IN} =V _{SS} or V _{DD}	5	0.25		0.25		7.5		μA	
			10	0.50		0.50		15			
			15	1.0		1.0		30			
			20	5.0		5.0		150			
Low Level Control Input Voltage	V _{ILC}	I _O < 1μA, V _O =0.5Vor4.5V V _O =1Vor9V V _O =1.5or13.5V	5	1		1		1	V		
			10	2		2		2			
			15	2		2		2			
High Level Control Input Voltage	V _{IHC}	I _O < 1μA, V _O =0.5Vor4.5V V _O =1Vor9V V _O =1.5or13.5V	5	3.5		3.5		3.5	V		
			10	7		7		7			
			15	11		11		11			
Input Current	I _{IN}	V _{IN} =0 or 18V	18	±0.1		±0.1			±1	μA	
Operating Voltage				3	18	3	18	3	18	V	
On-State Resistance	R _{ON}	V _{SS} =0V, V _{IS} =V _{SS} to V _{DD}	5	850		300	1050	1200	Ω		
			10	330		150	400	500			
			15	210		100	240	300			
Off-Channel Leakage Current		V _{SS} =0V, V _{IS} =V _{DD} , V _O =V _{SS}	18	0.1		0.1			1	μA	
SW to SW On-State Resistance Difference	ΔR _{ON}	V _{SS} =0V, V _{IS} =V _{SS} to V _{DD}	5			15			Ω		
			10			10					
			15			5					

■ SWITCHING CHARACTERISTICS

 (Ta=25°C, V_{SS}=0V)

PARAMETER		SYMBOL	CONDITIONS	V _{DD} (V)	MIN	TYP	MAX	UNIT
Propagation Delay Time	In - Out	t _{PHL}	R _L =10kΩ C _L =50pF V _C =V _{DD}	5	20	40	ns	
	Out - In	t _{PLH}		10	10	20		
				15	7	15		
Cut-Off Frequency (ON)			R _L =1kΩ, 20log(V _{OUT} /V _{IN})=-3dB V _C =V _{DD} , V _{IS} =5V _{P-P} , V _{SS} =-5V	5	40		MHz	
Propagation Delay Time	Control-Out	t _{PZH}	R _L =10kΩ, C _L =50pF V _{IS} =V _{DD} , R _L →V _{SS}	5	35	70	ns	
	Control-Out	t _{PZL}		10	20	40		
				15	15	30		
Sine-Wave Distortion			R _L =10kΩ, V _{SS} =-5V V _C =V _{DD} , f=1kHz, V _{IS} =5V _{P-P}	5	0.05		%	
Crosstalk	SW A to B		R _L =1kΩ, 20log(V _{OUT} /V _{IN})=-50dB V _C =V _{SS} =-5V, V _{IS} =5V _{P-P} , R _{IN} =10kΩ	5	8		MHz	
	Control-Out		R _L =1kΩ, V _{SS} =0V V _C =10V _{P-P}	10	50		mV	
Feedthrough All Channels Off			R _L =1kΩ, 20log(V _{OUT} /V _{IN})=-50dB V _C =V _{SS} =-5V, V _{IS} =5V _{P-P}	5	1		MHz	
Input Capacitance		C _{IN}				7.5	pF	



MEMO

[CAUTION]







The specifications on this databook are only given for information, without any guarantee as regards either mistakes or omissions. The application circuits in this databook are described only to show representative usages of the product and not intended for the guarantee or permission of any right including the industrial rights.

Looking for pricing, stock, or lifecycle information?

Click below to explore more details on WIN SOURCE:

-  [View NJU4066BM on WIN SOURCE](#)
-  [NJR Corporation/NJRC Information](#)

Optimize Your Supply Chain with WIN SOURCE Solutions

-  Global Sourcing Solution
-  Obsolete Management
-  Cost Control Management
-  Shortage Management
-  Alternative Solution
-  Excess Inventory Management