

LOW POWER AND LOW OFFSET VOLTAGE SUPER SMALL-SIZED SINGLE C-MOS OPERATIONAL AMPLIFIER

■GENERAL DESCRIPTION

The **NJU7007/08** are super small-sized package single C-MOS operational amplifiers operated on a single-power-supply, low power, low offset voltage and low operating current.

The input offset voltage is lower than 4mV, and the input bias current is as low as than 1pA, consequently very small signal around the ground level can be amplified.

The minimum operating voltage is 1V and the output stage permits output signal to swing between both of the supply rails.

Furthermore, The **NJU7007/08** are packaged with super small-sized SC88A, therefore it can be especially applied to portable items.

■PACKAGE INFORMATION



NJU7007F3
NJU7008F3

■FEATURES

- Low Offset Voltage $V_{IO}=4\text{mV max}$
- Single Low Power Supply $V_{DD}=1.0\sim 5.5\text{V}$
- Wide Output Swing Range $V_{OM}=2.9\text{V min @ } V_{DD}=3.0\text{V}$
(See Line-up)
- Low Operating Current $I_{IB}=1\text{pA typ}$
- Low Bias Current
- Compensation Capacitor Incorporated
- Package Outline SC88A
- C-MOS Technology

■PIN CONFIGURATION

(Top View)

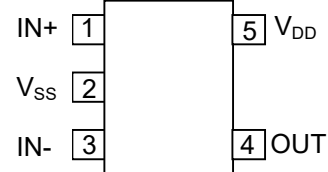

■LINE-UP

($V_{DD}=3.0\text{V}, T_a=25^\circ\text{C}$)

PARAMETER	NJU7007	NJU7008	UNIT
Operating Current	15	200	$\mu\text{A}(\text{typ})$
Slew Rate	0.1	2.4	$\text{V}/\mu\text{s}(\text{typ})$
Unity Gain Bandwidth	0.2	1.0	$\text{MHz}(\text{typ})$

■EQUIVALENT CIRCUIT

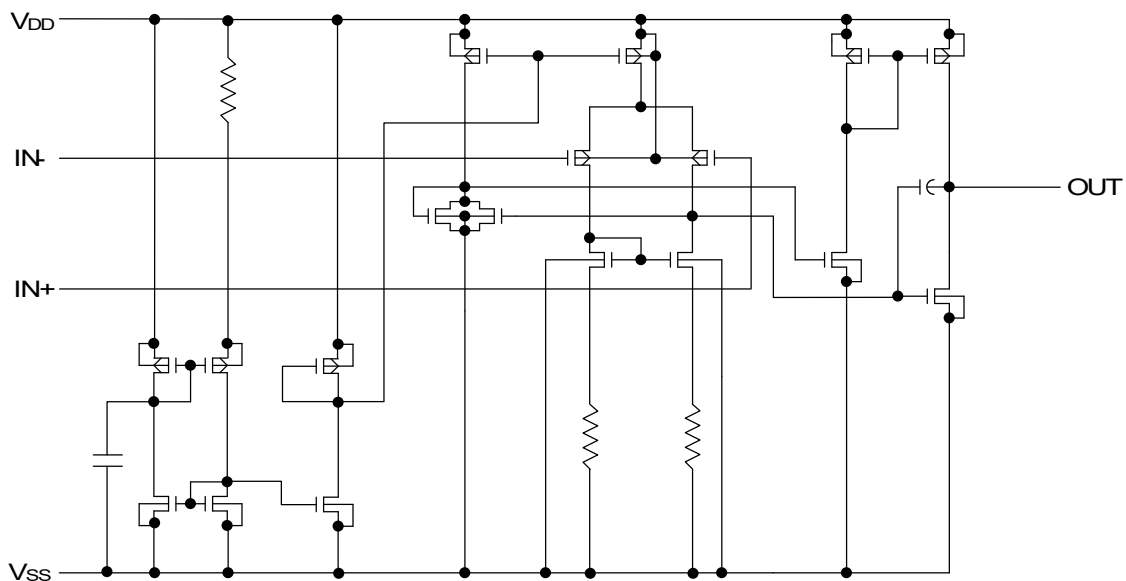

■ABSOLUTE MAXIMUM RATINGS

(Ta=25°C)

PARAMETER	SYMBOL	RATING	UNIT
Supply Voltage	V _{DD}	7.0	V
Differential Input Voltage	V _{ID}	±7.0 (Note1)	V
Common Mode Input Voltage	V _{IC}	-0.3~7.0	V
Power Dissipation	P _D	250 (Note2)	mW
Operating Temperature	T _{opr}	-40~+85	°C
Storage Temperature	T _{stg}	-55~+125	°C

 Note1) If the supply voltage (V_{DD}) is less than 7.0V, the input voltage must not over the V_{DD} level though 7.0V is limit specified.

Note2) The power dissipation is value mounted on a glass epoxy board (FR-4) in size of 114.3x76.2x1.6 mm.

 Note3) Decoupling capacitor should be connected between V_{DD} and V_{SS} due to the stabilized operation for the circuit.

■ELECTRICAL CHARACTERISTICS

NJU7007

 (V_{DD}=3.0V, R_L=∞, Ta=25°C)

PARAMETER	SYMBOL	CONDITIONS	MIN	TYP	MAX	UNIT
Input Offset Voltage	V _{IO}	V _{IN} =V _{DD} /2	-	-	4	mV
Input Offset Current	I _{IO}		-	1	-	pA
Input Bias Current	I _{IB}		-	1	-	pA
Input Impedance	R _{IN}		-	1	-	TΩ
Large Signal Voltage Gain	A _{VD}		60	70	-	dB
Input Common Mode Voltage Range	V _{ICM}		0~2.5	-	-	V
Maximum Output Swing Voltage	V _{OM1}	R _L =1MΩ	V _{DD} -0.1	-	-	V
	V _{OM2}	R _L =1MΩ	-	-	V _{SS} +0.1	V
Output Source Current	I _{OH}	V _O =V _{DD} /2	7	12	-	μA
Common Mode Rejection Ratio	CMR	V _{IN} =V _{DD} /2	55	65	-	dB
Supply Voltage Rejection Ratio	SVR	V _{DD} =1.5~5.5V	60	70	-	dB
Operating Current	I _{DD}		-	15	25	μA
Slew Rate	SR		-	0.1	-	V/μs
Unity Gain Bandwidth	Ft	A _V =40dB, C _L =10pF	-	0.2	-	MHz

NJU7008

 (V_{DD}=3.0V, R_L=∞, Ta=25°C)

PARAMETER	SYMBOL	CONDITIONS	MIN	TYP	MAX	UNIT
Input Offset Voltage	V _{IO}	V _{IN} =V _{DD} /2	-	-	4	mV
Input Offset Current	I _{IO}		-	1	-	pA
Input Bias Current	I _{IB}		-	1	-	pA
Input Impedance	R _{IN}		-	1	-	TΩ
Large Signal Voltage Gain	A _{VD}		60	70	-	dB
Input Common Mode Voltage Range	V _{ICM}		0~2.5	-	-	V
Maximum Output Swing Voltage	V _{OM1}	R _L =50kΩ	V _{DD} -0.1	-	-	V
	V _{OM2}	R _L =50kΩ	-	-	V _{SS} +0.1	V
Output Source Current	I _{OH}	V _O =V _{DD} /2	100	200	-	μA
Common Mode Rejection Ratio	CMR	V _{IN} =V _{DD} /2	55	65	-	dB
Supply Voltage Rejection Ratio	SVR	V _{DD} =1.5~5.5V	60	70	-	dB
Operating Current	I _{DD}		-	200	400	μA
Slew Rate	SR		-	2.4	-	V/μs
Unity Gain Bandwidth	Ft	A _V =40dB, C _L =10pF	-	1.0	-	MHz

■ TYPICAL CHARACTERISTICS

(1) NJU7007

Output Voltage vs. Output Current (SOURCE)

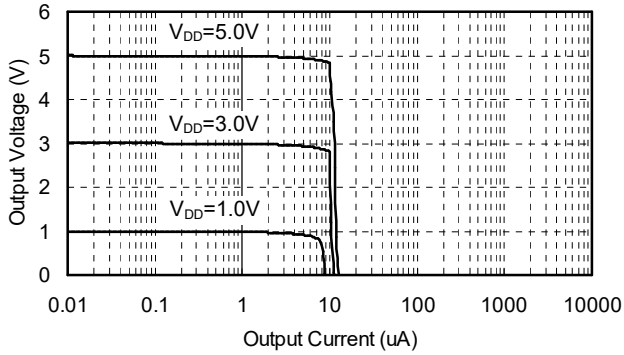

Output Voltage vs. Output Current (SINK)

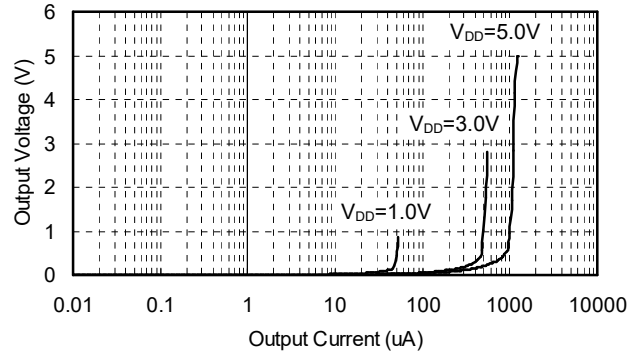

(2) NJU7008

Output Voltage vs. Output Current (SOURCE)

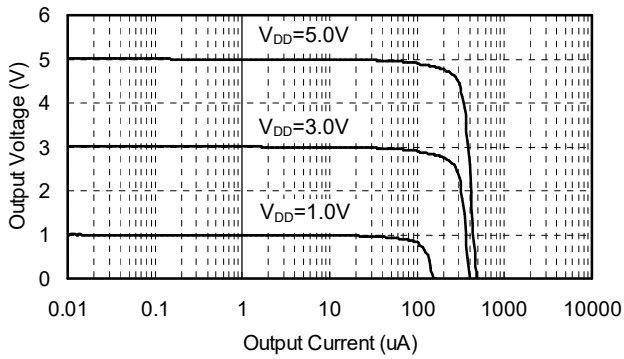

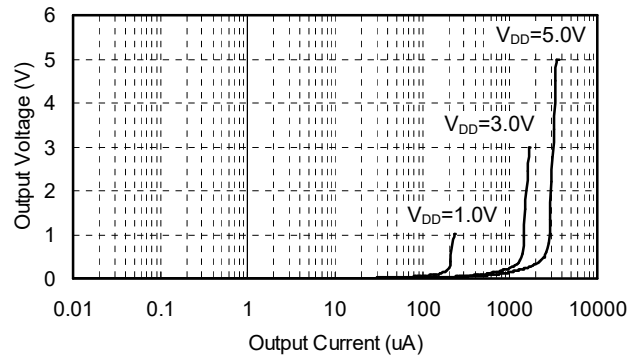

Output Voltage vs. Output Current (SINK)



[CAUTION]
 The specifications on this data book are only given for information, without any guarantee as regards either mistakes or omissions. The application circuits in this data book are described only to show representative usages of the product and not intended for the guarantee or permission of any right including the industrial rights.

Looking for pricing, stock, or lifecycle information?

Click below to explore more details on WIN SOURCE:

-  [View NJU7008F3-TE1 on WIN SOURCE](#)
-  [NJR Corporation/NJRC Information](#)

Optimize Your Supply Chain with WIN SOURCE Solutions

-  Global Sourcing Solution
-  Obsolete Management
-  Cost Control Management
-  Shortage Management
-  Alternative Solution
-  Excess Inventory Management