

LOW VOLTAGE C-MOS OPERATIONAL AMPLIFIER

■ GENERAL DESCRIPTION

The NJU7031/32/34 are single, dual and quad single supply, low offset, output full swing C-MOS Operational Amplifiers.

The wide operating voltage 3V to 16V, High slew rate 3.5V/ μ s and output full swing are suitable for fast signal processing amplifiers. Additionally, low input bias current 1pA, and single supply operation offer amplification of the very small signal around the ground level.

The NJU7031 has external offset null function.

■ FEATURES

- High Slew Rate 3.5V/ μ s
- Wide Operating Voltage +3V to +16V
- Output Voltage with full Swing $V_{OM}=9.98V$ typ. (@ $V_{DD}=10V$)
- Input Common Mode Voltage Range $V_{ICM}=0V$ to 9V (@ $V_{DD}=10V$)
- Low Bias Current $I_{IB}=1pA$ typ.
- Input Common Mode Voltage range includes ground.
- External Offset Null Adjustment (Only NJU7031)
- C-MOS Technology
- Package Outline NJU7031 (single) DIP8, DMP8, SSOP8
NJU7032 (dual) DIP8, DMP8
NJU7034 (quad) DIP14, DMP14, SSOP14

■ PACKAGE OUTLINE

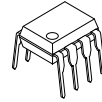

NJM7031D
NJU7032D



NJM7031M
NJU7032M



NJM7031V

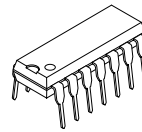

NJM7034D

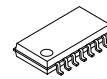

NJM7034M



NJM7034V

■ PIN CONFIGURATION

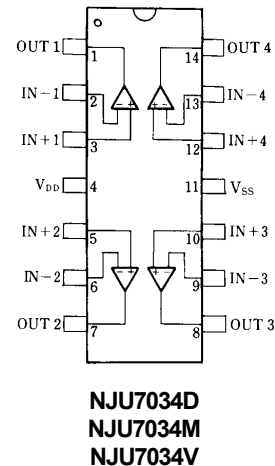
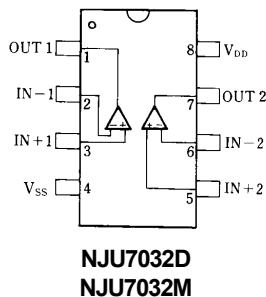
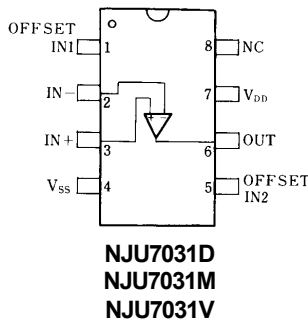

■ EQUIVALENT CIRCUIT



* The terminals IN1, IN2 are only for NJU7031
(NJU7032/34 don't have these terminals).

NJU7031/32/34

■ ABSOLUTE MAXIMUM RATINGS

(Ta=25°C)

PARAMETER	SYMBOL	RATINGS	UNIT
Supply Voltage	V_{DD}	18	V
Differential Input Voltage	V_{ID}	± 18 (note1)	V
Common Mode Input Voltage	V_{IC}	-0.3~18	V
Power Dissipation	P_D	(DIP14) 700 (DIP8) 500 (DMP8,14) 300 (SSOP8,14) 300	mW
Operating Temperature Range	T_{opr}	-40~+85	°C
Storage Temperature Range	T_{stg}	-40~+125	°C

(note1) If the supply voltage (V_{DD}) is less than 18V, the input voltage must not over the V_{DD} level though 18V is limit specified.

■ ELECTRICAL CHARACTERISTICS

(Ta=25°C, $V_{DD}=10V, R_L=\infty$)

PARAMETER	SYMBOL	TEST CONDITION	MIN.	TYP.	MAX.	UNIT
Input Offset Voltage	V_{IO}	$R_S=50\Omega$	-	-	10	mV
Input Offset Current	I_{IO}		-	1	-	pA
Input Bias Current	I_{IB}		-	1	-	pA
Input Impedance	R_{IN}		-	1	-	TΩ
Large Signal Voltage Gain	A_V		80	95	-	dB
Input Common Mode Voltage Range	V_{ICM}		0~9	-	-	V
Maximum Output Swing Voltage	V_{OM}	$R_L=1M\Omega$	9.80	9.98	-	V
Common Mode Rejection Ratio	CMR		60	75	-	dB
Supply Voltage Rejection Ratio	SVR		60	75	-	dB
Operating Current/Circuit	I_{DD}		-	1	2	mA/Cir
Slew Rate	SR		-	3.5	-	V/ μ s
Unity Gain Bandwidth	F_t	$A_V=40dB, C_L=10pF$	-	1.5	-	MHz

■ OFFSET ADJUSTMENT CIRCUIT (Only For NJU7031)



■ TYPICAL CHARACTERISTICS

Current Consumption vs. Operating Voltage

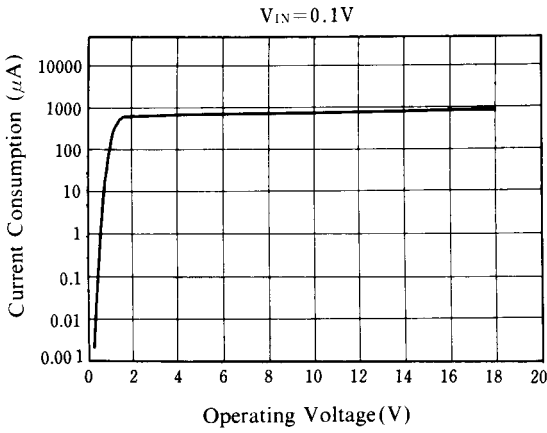

Offset Voltage vs. Operating Voltage

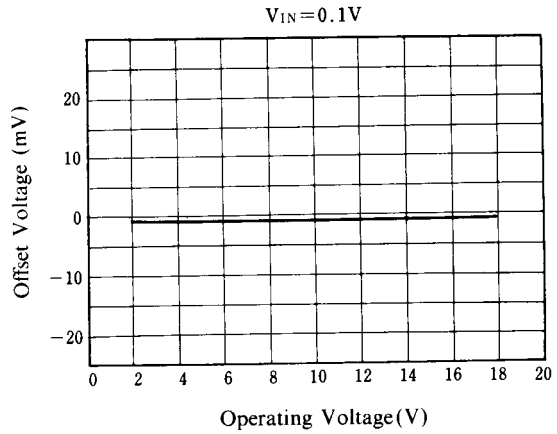

Output Current vs. Operating Voltage

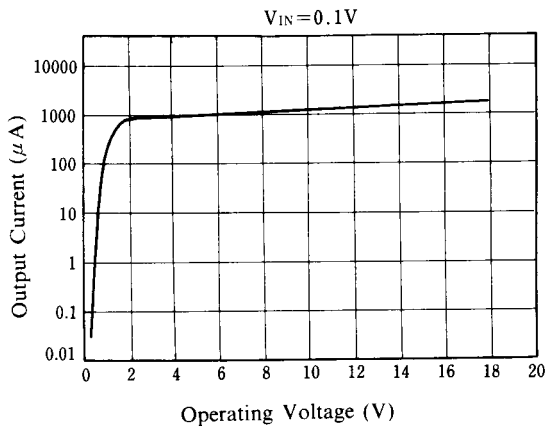

Offset Voltage vs. Input Voltage

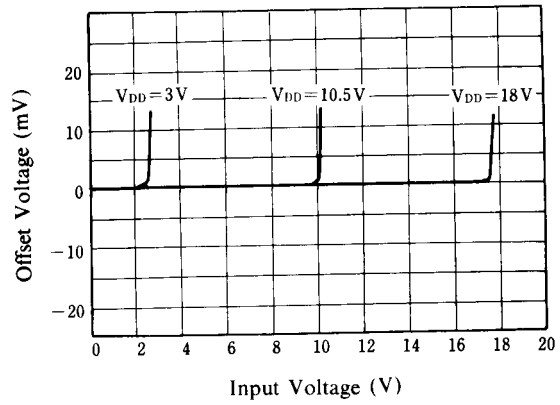

Output Voltage vs. Output Current

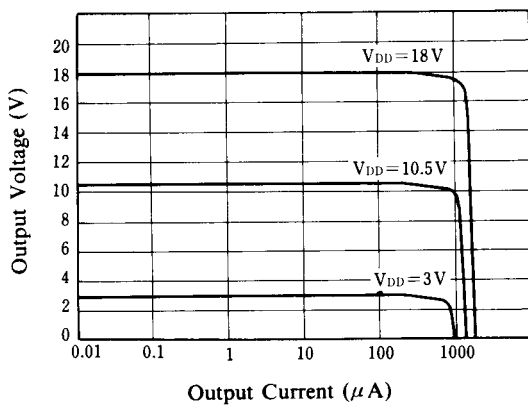

Maximum Output Swing Voltage vs. Frequency

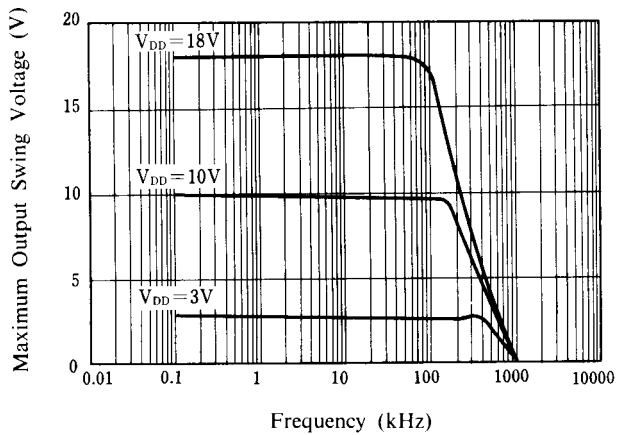



■ TYPICAL CHARACTERISTICS



[CAUTION]
 The specifications on this databook are only given for information, without any guarantee as regards either mistakes or omissions. The application circuits in this databook are described only to show representative usages of the product and not intended for the guarantee or permission of any right including the industrial rights.

Looking for pricing, stock, or lifecycle information?

Click below to explore more details on WIN SOURCE:

-  [View NJU7031M# on WIN SOURCE](#)
-  [NJR Corporation/NJRC Information](#)

Optimize Your Supply Chain with WIN SOURCE Solutions

-  Global Sourcing Solution
-  Obsolete Management
-  Cost Control Management
-  Shortage Management
-  Alternative Solution
-  Excess Inventory Management