

C-MOS 3-TERMINAL NEGATIVE VOLTAGE REGULATOR

■ GENERAL DESCRIPTION

The **NJU7211 series** is a C-MOS 3-terminal negative voltage regulator which contains internal precision voltage reference, error amplifier, control transistor and output voltage setting resistor.

The regulation voltage is fixed by internal circuits and the following line-up of different output voltage versions are available.

The **NJU7211 series** is suitable for battery operated items and battery back-up systems because of low operating current and low dropout voltage.

■ FEATURES

- Low Operating Current (19 μ A typ.)
- Wide Operating Voltage Range
- Low Dropout Voltage
 - ($\Delta V_{IO} < 0.6V$ -3.0V output, $I_{OUT} = 20mA$)
 - ($\Delta V_{IO} < 0.6V$ -5.0V output, $I_{OUT} = 40mA$)
- Small Temperature Coefficient of Output Voltage
- Package Outline (TO-92/SOT-89)
- C-MOS Technology

■ OUTPUT VOLTAGE LINE-UP

Output Voltage	TO-92 Type	SOT-89 Type
-2.0V	NJU7211L20	NJU7211U20
-3.0V	NJU7211L30	NJU7211U30
-4.0V	NJU7211L40	NJU7211U40
-5.0V	NJU7211L50	NJU7211U50

■ EQUIVALENT CIRCUIT

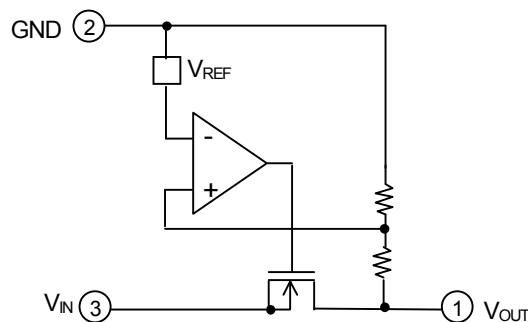

■ PACKAGE OUTLINE



NJU7211L(TO-92)

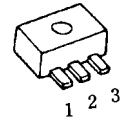

NJU7211U(SOT-89)

■ TERMINAL DESCRIPTION

No.	Description
1	Output
2	GND
3	Input

NJU7211 Series

■ ABSOLUTE MAXIMUM RATINGS

($T_a = 25^\circ\text{C}$)

PARAMETER	SYMBOL	RATINGS	UNIT
Input Voltage	V_{IN}	-14	V
Output Voltage	V_{OUT}	GND+0.3 to V_{IN} -0.3	V
Output Current	I_{OUT}	100	mA
Power Dissipation	P_D	500 (TO-92) 300 (SOT-89)	mW
Operating Temperature	T_{opr}	-25 to +75	$^\circ\text{C}$
Storage Temperature	T_{stg}	-40 to +125	$^\circ\text{C}$
Soldering Temperature / Time	T_{sold}	260 $^\circ\text{C}$ /10 sec	-

■ ELECTRICAL CHARACTERISTICS

-2.0V Version

($C_{IN} = C_o = 0.1\mu\text{F}$, $T_a = 25^\circ\text{C}$)

PARAMETER	SYMBOL	CONDITION	MIN.	TYP.	MAX.	UNIT
Output Voltage	V_{OUT}	$V_{IN} = -4.0\text{V}$, $I_{OUT} = 10\text{mA}$	-2.10	-2.00	-1.90	V
Dropout Voltage	ΔV_{IO}	$I_{OUT} = 20\text{mA}$	-	0.2	0.6	V
Input Voltage	V_{IN}		-12	-	-	V
Operating Current	I_Q	$V_{IN} = -4.0\text{V}$	-	19	30	μA
Load Regulation	$\Delta V_{OUT} / \Delta I_{OUT}$	$V_{IN} = -4.0\text{V}$, $I_{OUT} = 1 \sim 20\text{mA}$	-	-	120	mV
Line Regulation	$\Delta V_{OUT} / (\Delta V_{IN} \cdot V_{OUT})$	$V_{IN} = -3.0 \sim -12\text{V}$	-	0.1	-	%/V

-3.0V Version

($C_{IN} = C_o = 0.1\mu\text{F}$, $T_a = 25^\circ\text{C}$)

PARAMETER	SYMBOL	CONDITION	MIN.	TYP.	MAX.	UNIT
Output Voltage	V_{OUT}	$V_{IN} = -5.0\text{V}$, $I_{OUT} = 10\text{mA}$	-3.15	-3.00	-2.85	V
Dropout Voltage	ΔV_{IO}	$I_{OUT} = 20\text{mA}$	-	0.2	0.6	V
Input Voltage	V_{IN}		-12	-	-	V
Operating Current	I_Q	$V_{IN} = -5.0\text{V}$	-	19	30	μA
Load Regulation	$\Delta V_{OUT} / \Delta I_{OUT}$	$V_{IN} = -5.0\text{V}$, $I_{OUT} = 1 \sim 20\text{mA}$	-	80	120	mV
Line Regulation	$\Delta V_{OUT} / (\Delta V_{IN} \cdot V_{OUT})$	$V_{IN} = -4.0 \sim -12\text{V}$	-	0.1	-	%/V

-4.0V Version

($C_{IN} = C_o = 0.1\mu\text{F}$, $T_a = 25^\circ\text{C}$)

PARAMETER	SYMBOL	CONDITION	MIN.	TYP.	MAX.	UNIT
Output Voltage	V_{OUT}	$V_{IN} = -6.0\text{V}$, $I_{OUT} = 30\text{mA}$	-5.25	-5.00	-4.75	V
Dropout Voltage	ΔV_{IO}	$I_{OUT} = 40\text{mA}$	-	0.3	0.6	V
Input Voltage	V_{IN}		-12	-	-	V
Operating Current	I_Q	$V_{IN} = -6.0\text{V}$	-	19	30	μA
Load Regulation	$\Delta V_{OUT} / \Delta I_{OUT}$	$V_{IN} = -6.0\text{V}$, $I_{OUT} = 1 \sim 40\text{mA}$	-	-	120	mV
Line Regulation	$\Delta V_{OUT} / (\Delta V_{IN} \cdot V_{OUT})$	$V_{IN} = -5.0 \sim -12\text{V}$	-	0.1	-	%/V

-5.0V Version

($C_{IN} = C_o = 0.1\mu\text{F}$, $T_a = 25^\circ\text{C}$)

PARAMETER	SYMBOL	CONDITION	MIN.	TYP.	MAX.	UNIT
Output Voltage	V_{OUT}	$V_{IN} = -7.0\text{V}$, $I_{OUT} = 30\text{mA}$	-5.25	-5.00	-4.75	V
Dropout Voltage	ΔV_{IO}	$I_{OUT} = 40\text{mA}$	-	0.3	0.6	V
Input Voltage	V_{IN}		-12	-	-	V
Operating Current	I_Q	$V_{IN} = -7.0\text{V}$	-	19	30	μA
Load Regulation	$\Delta V_{OUT} / \Delta I_{OUT}$	$V_{IN} = -7.0\text{V}$, $I_{OUT} = 1 \sim 40\text{mA}$	-	80	120	mV
Line Regulation	$\Delta V_{OUT} / (\Delta V_{IN} \cdot V_{OUT})$	$V_{IN} = -6.0 \sim -12\text{V}$	-	0.1	-	%/V

■ MEASUREMENT CIRCUIT

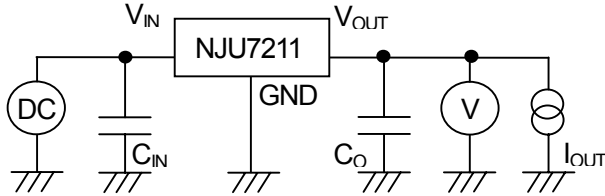



[CAUTION]

The specifications on this databook are only given for information, without any guarantee as regards either mistakes or omissions. The application circuits in this databook are described only to show representative usages of the product and not intended for the guarantee or permission of any right including the industrial rights.

Looking for pricing, stock, or lifecycle information?

Click below to explore more details on WIN SOURCE:

-  [View NJU7211U50-TE1 on WIN SOURCE](#)
-  [NJR Corporation/NJRC Information](#)

Optimize Your Supply Chain with WIN SOURCE Solutions

-  Global Sourcing Solution
-  Obsolete Management
-  Cost Control Management
-  Shortage Management
-  Alternative Solution
-  Excess Inventory Management