

## LOW DROPOUT VOLTAGE REGULATOR

### ■ GENERAL DESCRIPTION

NJU7771/72/73/74/75/76 is a low dropout voltage regulator designed for portable items.

Advanced CMOS technology achieves high ripple rejection and low quiescent current.

NJU7774/75/76 features shunt switch which improves turn off response of output voltage when ON/OFF control is used.

### ■ FEATURES

- High Ripple Rejection      65dB typ. (f=1kHz, Vo=3.0V version)
- Low quiescent Current      Iq=18μA (Io=0mA)
- Output capacitor with 1.0μF ceramic capacitor (Vo>2.0V version)
- Output Current              Io(max.)=150mA
- High Precision Output      Vo±1.0%
- Low Dropout Voltage        0.15V typ. (Io=100mA, Vo=3.0V)
- Input Voltage Range        VIN=+2.3V~9V (Vo≤2.0V version)
- ON/OFF Control            (Active High)
- With Shunt Switch         Only NJU7774/75/76
- Internal Short Circuit Current Limit
- Internal Thermal Overload Protection
- CMOS Technology
- Package Outline             SOT-23-5

### ■ PACKAGE OUTLINE

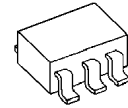

NJU777\*F

### ■ PIN CONFIGURATION

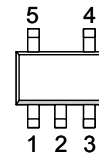

PIN FUNCTION

1.CONTROL	1.V <sub>IN</sub>	1.V <sub>OUT</sub>
2.GND	2.GND	2.GND
3.NC	3.CONTROL	3.V <sub>IN</sub>
4.V <sub>OUT</sub>	4.NC	4.CONTROL
5.V <sub>IN</sub>	5.V <sub>OUT</sub>	5.NC
NJU7771F	NJU7772F	NJU7773F
NJU7774F	NJU7775F	NJU7776F

### ■ EQUIVALENT CIRCUIT

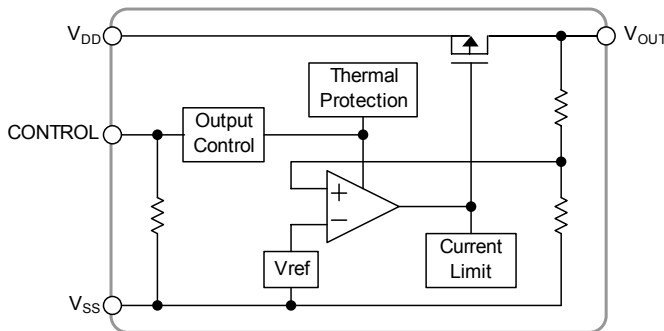

NJU7771/72/73

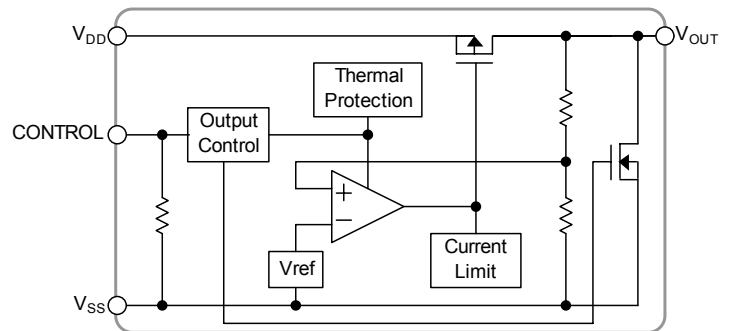

NJU7774/75/76

# NJU7771/72/73/74/75/76

## ■ OUTPUT VOLTAGE RANK LIST

### ● NJU7771

Device Name	V <sub>OUT</sub>	Device Name	V <sub>OUT</sub>	Device Name	V <sub>OUT</sub>	Device Name	V <sub>OUT</sub>
NJU7771F15	1.5V	NJU7771F23	2.3V	NJU7771F32	3.2V	NJU7771F04	4.0V
NJU7771F18	1.8V	NJU7771F25	2.5V	NJU7771F33	3.3V	NJU7771F42	4.2V
NJU7771F19	1.9V	NJU7771F27	2.7V	NJU7771F35	3.5V	NJU7771F05	5.0V
NJU7771F21	2.1V	NJU7771F28	2.8V	NJU7771F36	3.6V		
NJU7771F22	2.2V	NJU7771F03	3.0V	NJU7771F38	3.8V		

### ● NJU7772

Device Name	V <sub>OUT</sub>	Device Name	V <sub>OUT</sub>	Device Name	V <sub>OUT</sub>	Device Name	V <sub>OUT</sub>
NJU7772F15	1.5V	NJU7772F23	2.3V	NJU7772F32	3.2V	NJU7772F04	4.0V
NJU7772F18	1.8V	NJU7772F25	2.5V	NJU7772F33	3.3V	NJU7772F42	4.2V
NJU7772F19	1.9V	NJU7772F27	2.7V	NJU7772F35	3.5V	NJU7772F05	5.0V
NJU7772F21	2.1V	NJU7772F28	2.8V	NJU7772F36	3.6V		
NJU7772F22	2.2V	NJU7772F03	3.0V	NJU7772F38	3.8V		

### ● NJU7773

Device Name	V <sub>OUT</sub>	Device Name	V <sub>OUT</sub>	Device Name	V <sub>OUT</sub>	Device Name	V <sub>OUT</sub>
NJU7773F15	1.5V	NJU7773F23	2.3V	NJU7773F32	3.2V	NJU7773F04	4.0V
NJU7773F18	1.8V	NJU7773F25	2.5V	NJU7773F33	3.3V	NJU7773F42	4.2V
NJU7773F19	1.9V	NJU7773F27	2.7V	NJU7773F35	3.5V	NJU7773F05	5.0V
NJU7773F21	2.1V	NJU7773F28	2.8V	NJU7773F36	3.6V		
NJU7773F22	2.2V	NJU7773F03	3.0V	NJU7773F38	3.8V		

### ● NJU7774

Device Name	V <sub>OUT</sub>	Device Name	V <sub>OUT</sub>	Device Name	V <sub>OUT</sub>	Device Name	V <sub>OUT</sub>
NJU7774F15	1.5V	NJU7774F25	2.5V	NJU7774F33	3.3V	NJU7774F05	5.0V
NJU7774F18	1.8V	NJU7774F27	2.7V	NJU7774F35	3.5V		
NJU7774F21	2.1V	NJU7774F28	2.8V	NJU7774F38	3.8V		
NJU7774F22	2.2V	NJU7774F03	3.0V	NJU7774F04	4.0V		
NJU7774F23	2.3V	NJU7774F32	3.2V	NJU7774F42	4.2V		

### ● NJU7775

Device Name	V <sub>OUT</sub>	Device Name	V <sub>OUT</sub>	Device Name	V <sub>OUT</sub>	Device Name	V <sub>OUT</sub>
NJU7775F15	1.5V	NJU7775F25	2.5V	NJU7775F33	3.3V	NJU7775F05	5.0V
NJU7775F18	1.8V	NJU7775F27	2.7V	NJU7775F35	3.5V		
NJU7775F21	2.1V	NJU7775F28	2.8V	NJU7775F38	3.8V		
NJU7775F22	2.2V	NJU7775F03	3.0V	NJU7775F04	4.0V		
NJU7775F23	2.3V	NJU7775F32	3.2V	NJU7775F42	4.2V		

### ● NJU7776

Device Name	V <sub>OUT</sub>	Device Name	V <sub>OUT</sub>	Device Name	V <sub>OUT</sub>	Device Name	V <sub>OUT</sub>
NJU7776F15	1.5V	NJU7776F25	2.5V	NJU7776F33	3.3V	NJU7776F05	5.0V
NJU7776F18	1.8V	NJU7776F27	2.7V	NJU7776F35	3.5V		
NJU7776F21	2.1V	NJU7776F28	2.8V	NJU7776F38	3.8V		
NJU7776F22	2.2V	NJU7776F03	3.0V	NJU7776F04	4.0V		
NJU7776F23	2.3V	NJU7776F32	3.2V	NJU7776F42	4.2V		

## ■ ABSOLUTE MAXIMUM RATINGS

(Ta=25°C)

PARAMETER	SYMBOL	RATINGS	UNIT
Input Voltage	V <sub>IN</sub>	+10	V
Control Voltage	V <sub>CONT</sub>	+10(*1)	V
Power Dissipation	P <sub>D</sub>	SOT-23-5	350(*2)
			200(*3)
Operating Temperature	T <sub>opr</sub>	-40 ~ +85	°C
Storage Temperature	T <sub>stg</sub>	-40 ~ +125	°C
OFF-state Output Sink Current(*4)	I <sub>o</sub>	10	mA

(\*1): When input voltage is less than +10V, the absolute maximum control voltage is equal to the input voltage.

(\*2) : Mounted on glass epoxy board based on EIA/JEDEC. (114.3x76.2x1.6mm: 2Layers)

(\*3) : Device itself

(\*4): This maximum rating is applied to NJU7774/75/76.

## ■ Operating voltage

V<sub>IN</sub>=+2.3 ~ +9V (In case of Vo<2.1V version)

## ■ ELECTRICAL CHARACTERISTICS

(V<sub>IN</sub>=Vo+1V, C<sub>IN</sub>=0.1μF, Co=1.0μF(Co=2.2μF: Vo≤2.0V), Ta=25°C)

PARAMETER	SYMBOL	TEST CONDITION	MIN.	TYP.	MAX.	UNIT
Output Voltage	V <sub>o</sub>	I <sub>o</sub> =30mA	-1.0%	-	+1.0%	V
Input Voltage	V <sub>IN</sub>		-	-	9	V
Quiescent Current	I <sub>Q</sub>	I <sub>o</sub> =0mA, V <sub>CONT</sub> =V <sub>IN</sub>	-	18	35	μA
Quiescent Current at Control OFF	I <sub>Q(OFF)</sub>	V <sub>CONT</sub> =0V	-	0.1	1	μA
Output Current	I <sub>o</sub>	V <sub>o</sub> =0.1V (Vo≤2.0V)	150	-	-	mA
		V <sub>o</sub> =0.3V (Vo≥2.1V)				
Short Current Limit	I <sub>LIM</sub>	V <sub>o</sub> =0V	-	50	-	mA
Line Regulation	Δ V <sub>o</sub> /Δ V <sub>IN</sub>	V <sub>IN</sub> =Vo+1V ~ Vo+6.0V (Vo<3.0V)	-	-	0.20	%/V
		V <sub>IN</sub> =Vo+1V ~ 9.0V (Vo≥3.0V), I <sub>o</sub> =30mA				
Load Regulation	Δ V <sub>o</sub> /Δ I <sub>o</sub>	I <sub>o</sub> =0 ~ 100mA	-	-	0.03	%/mA
Dropout Voltage(*note 3)	Δ V <sub>I-O</sub>	I <sub>o</sub> =100mA, 2.1V≤Vo≤2.4V	-	0.2	0.3	V
		I <sub>o</sub> =100mA, 2.5V≤Vo≤2.7V	-	0.18	0.28	V
		I <sub>o</sub> =100mA, 2.8V≤Vo≤3.3V	-	0.15	0.25	V
		I <sub>o</sub> =100mA, 3.4V≤Vo≤5.0V	-	0.12	0.22	V
Ripple Rejection	RR	e <sub>in</sub> =200mVrms, f=1kHz, I <sub>o</sub> =10mA, V <sub>o</sub> =3.0V Version	-	65	-	dB
Average Temperature Coefficient of Output Voltage	Δ V <sub>o</sub> /Δ Ta	Ta=0 ~ 85°C, I <sub>o</sub> =10mA	-	±100	-	ppm/°C
Output Noise Voltage	V <sub>NO1</sub>	f=10Hz ~ 80kHz, I <sub>o</sub> =0mA, V <sub>o</sub> =3.0V Version	-	40	-	μVrms
	V <sub>NO2</sub>	f=10Hz~80kHz, I <sub>o</sub> =10mA, V <sub>o</sub> =3.0V Version	-	70	-	μVrms
Pull-down Resistance	R <sub>CONT</sub>		2	5	10	MΩ
Control Voltage for ON-state	V <sub>CONT(ON)</sub>		1.6	-	-	V
Control Voltage for OFF-state	V <sub>CONT(OFF)</sub>		-	-	0.3	V
Pull-down Resistance at OFF-state(*6)	R <sub>O(OFF)</sub>	V <sub>CONT</sub> =0V (V <sub>o</sub> =3.0V Version)	-	120	-	Ω

(\*5): Except output voltage less than 2.1V.

(\*6) This electrical characteristics is applied to NJU7774/75/76.

The above specification is a common specification for all output voltages.

Therefore, it may be different from the individual specification for a specific output voltage.

# NJU7771/72/73/74/75/76

## TEST CIRCUIT

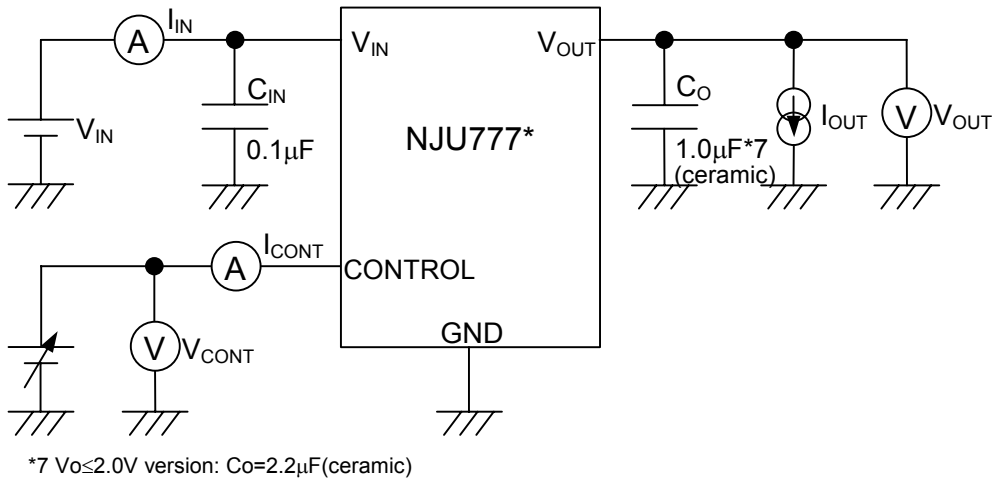

## POWER DISSIPATION vs. AMBIENT TEMPERATURE

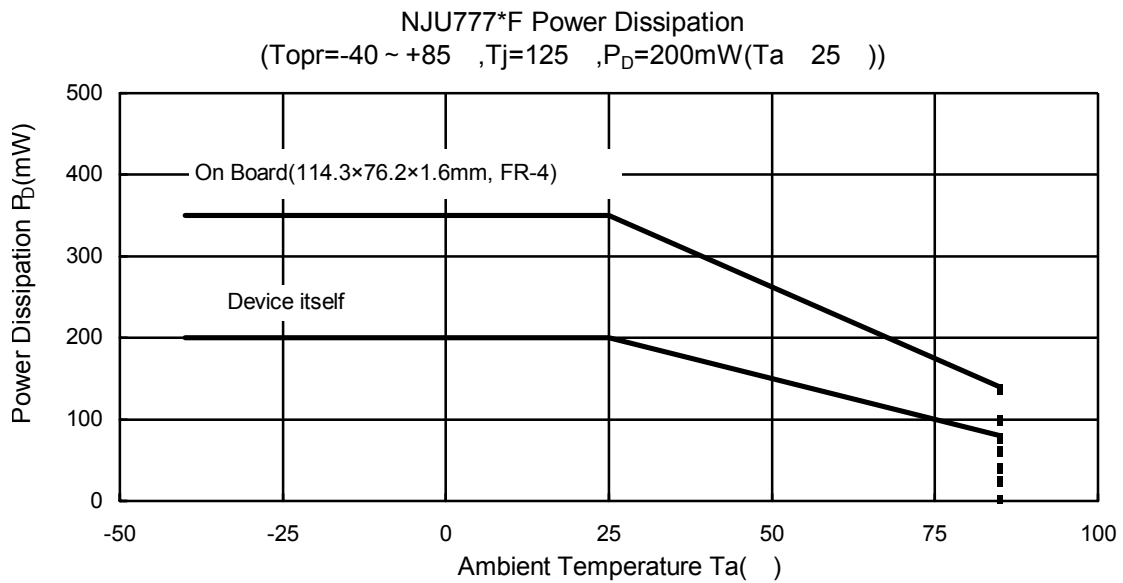

## ■ TYPICAL APPLICATION

① In case that ON/OFF Control is not required:

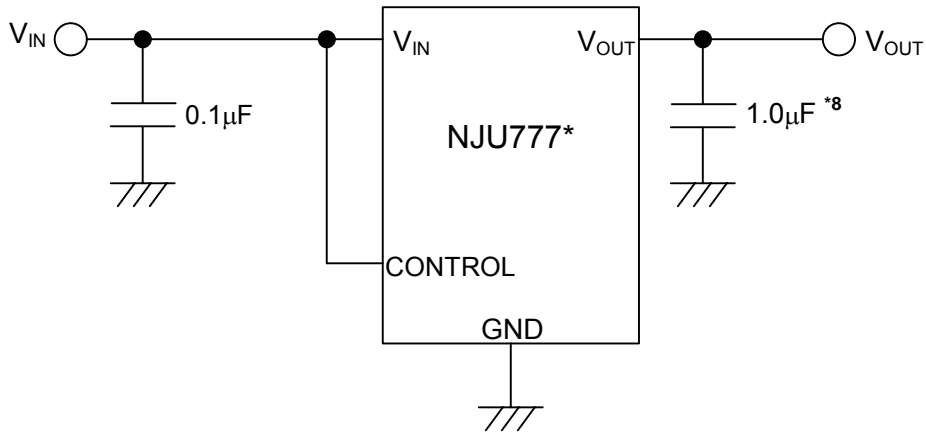

\*8  $V_o \leq 2.0V$  version:  $C_o = 2.2\mu F$

Connect control terminal to  $V_{IN}$  terminal.

② In use of ON/OFF Control

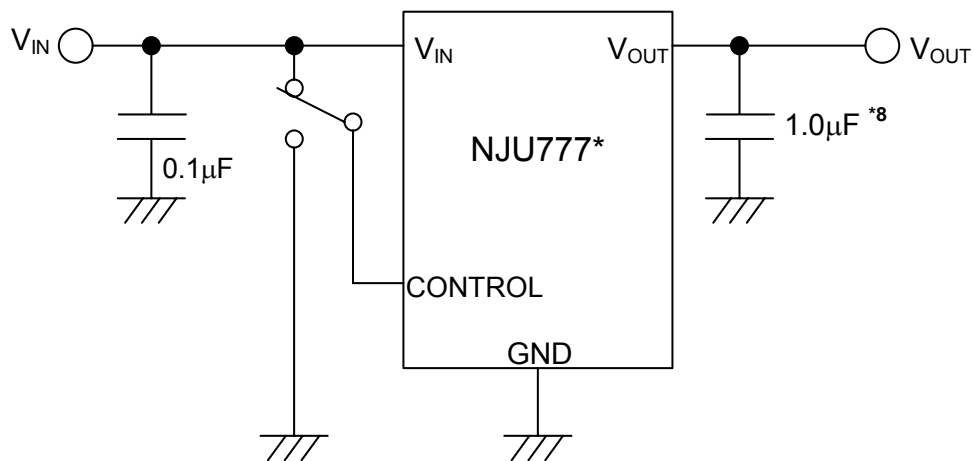

\*8  $V_o \leq 2.0V$  version:  $C_o = 2.2\mu F$

State of control terminal:

- "H" → output is enabled.
- "L" or "open" → output is disabled.

## \*Input Capacitor $C_{IN}$

Input Capacitor  $C_{IN}$  is required to prevent oscillation and reduce power supply ripple for applications when high power supply impedance or a long power supply line.

Therefore, use the recommended  $C_{IN}$  value (refer to conditions of ELECTRIC CHARACTERISTIC) or larger and should connect between GND and  $V_{IN}$  as shortest path as possible to avoid the problem.

## \*Output Capacitor $C_O$

Output capacitor ( $C_O$ ) will be required for a phase compensation of the internal error amplifier.

The capacitance and the equivalent series resistance (ESR) influence to stable operation of the regulator.

Use of a smaller  $C_O$  may cause excess output noise or oscillation of the regulator due to lack of the phase compensation.

On the other hand, Use of a larger  $C_O$  reduces output noise and ripple output, and also improves output transient response when rapid load change.

Therefore, use the recommended  $C_O$  value (refer to conditions of ELECTRIC CHARACTERISTIC) or larger and should connect between GND and  $V_{OUT}$  as shortest path as possible for stable operation

The recommended capacitance depends on the output voltage rank. Especially, low voltage regulator requires larger  $C_O$  value.

In addition, you should consider varied characteristics of capacitor (a frequency characteristic, a temperature characteristic, a DC bias characteristic and so on) and unevenness peculiar to a capacitor supplier enough.

When selecting  $C_O$ , recommend that have withstand voltage margin against output voltage and superior temperature characteristic though this product is designed stability works with wide range ESR of capacitor including low ESR products.

## ■ ELECTRICAL CHARACTERISTICS

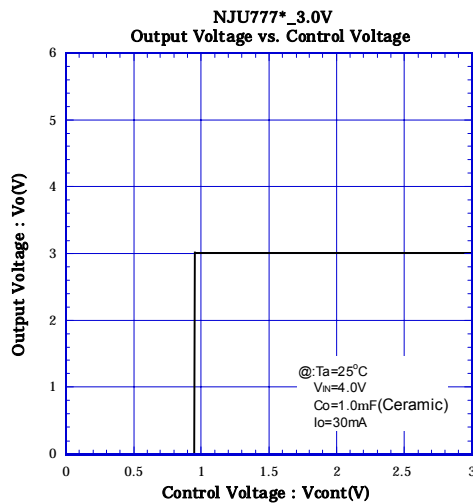
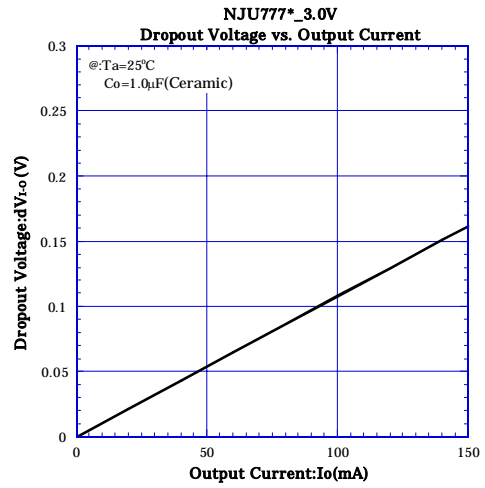
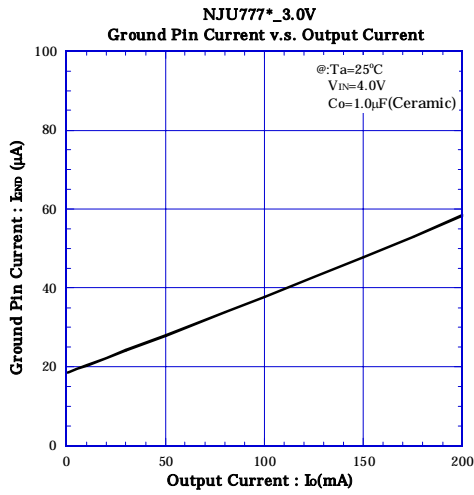
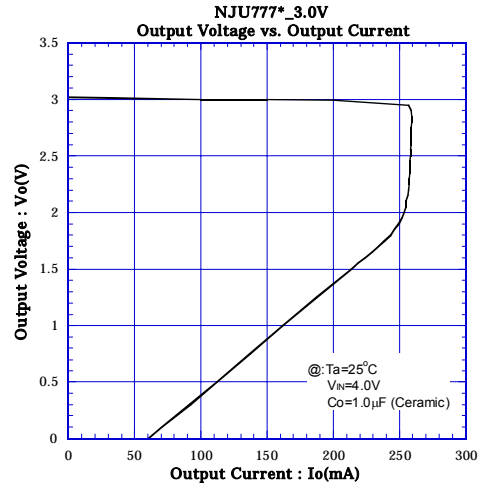
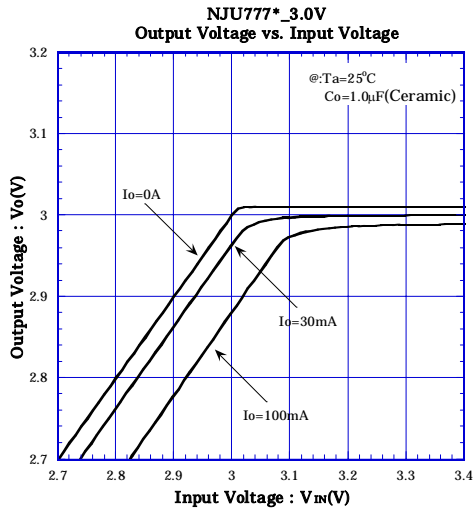

# NJU7771/72/73/74/75/76

## ■ ELECTRICAL CHARACTERISTICS

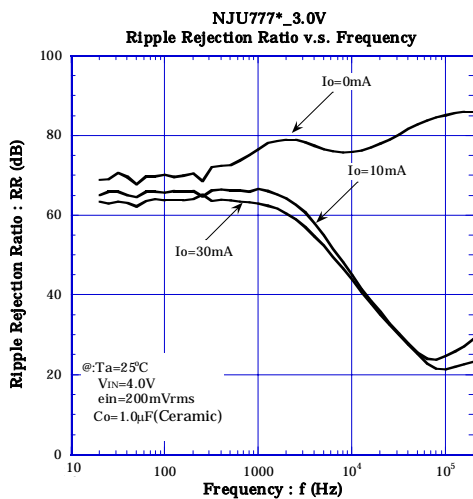
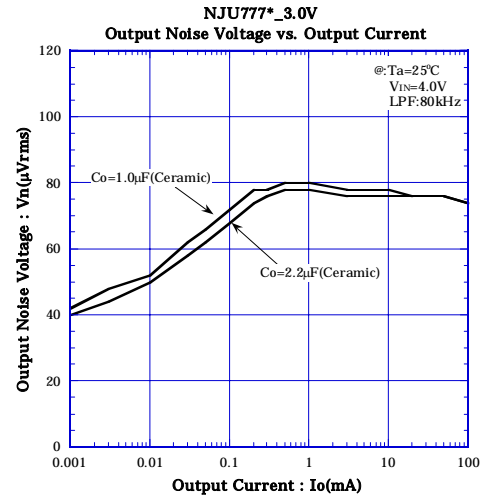
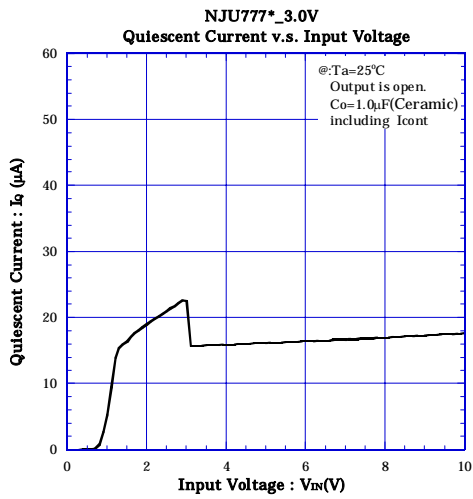
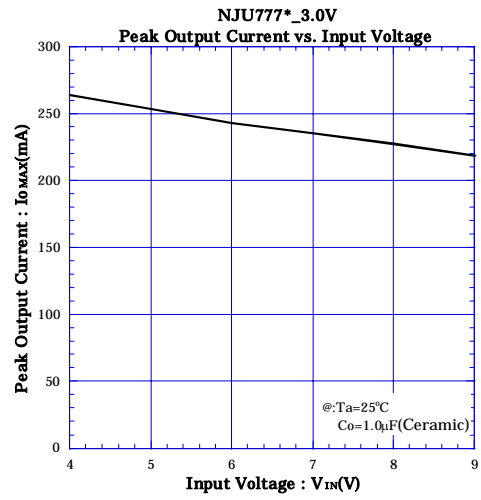
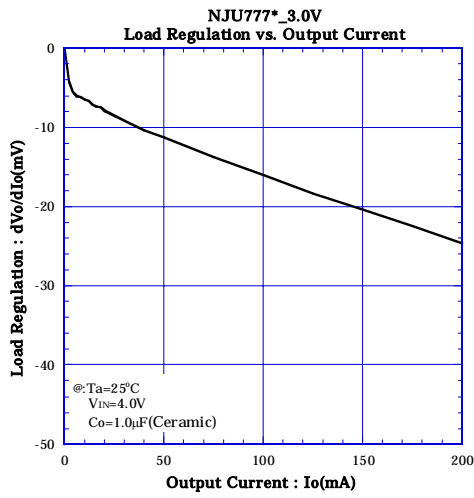

## ELECTRICAL CHARACTERISTICS

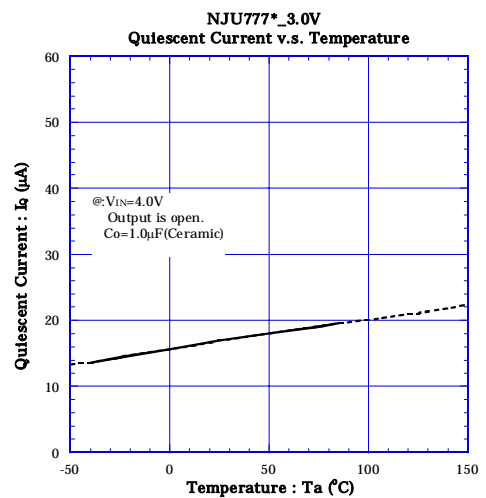
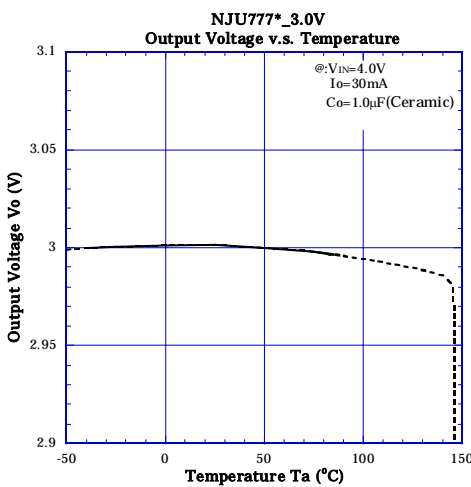
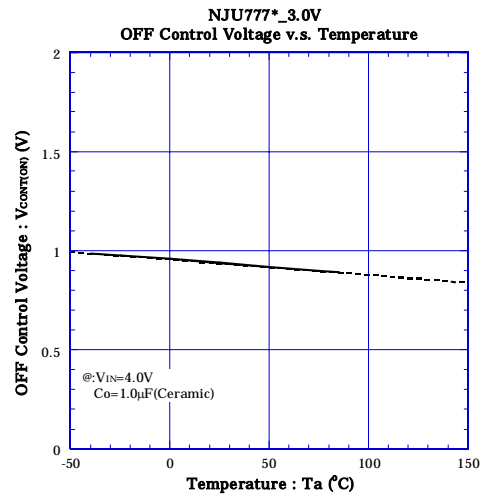
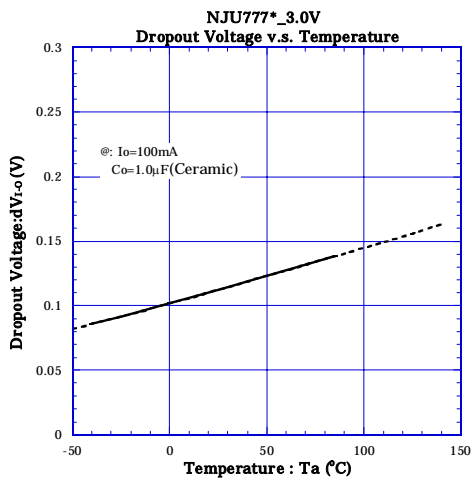
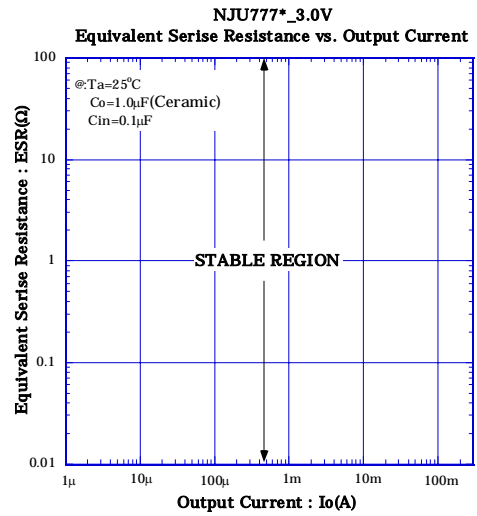
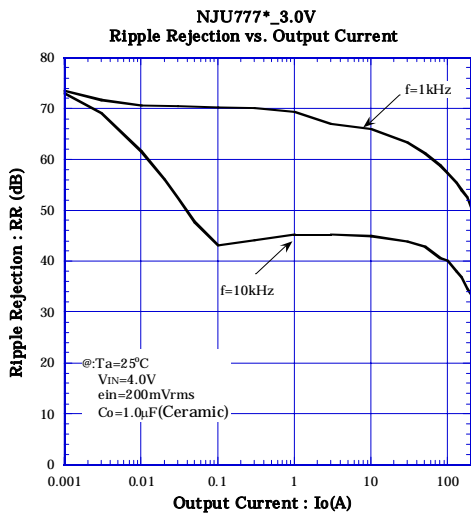

# NJU7771/72/73/74/75/76

## ■ ELECTRICAL CHARACTERISTICS

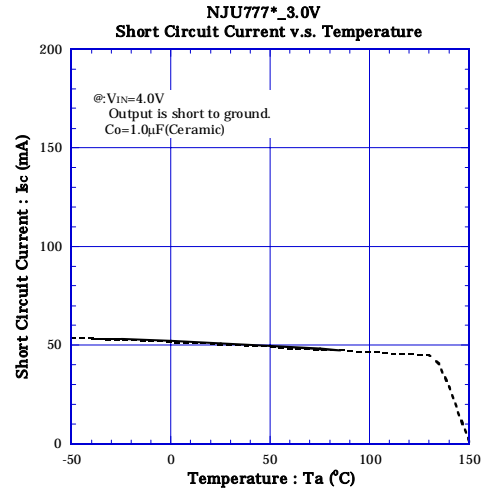
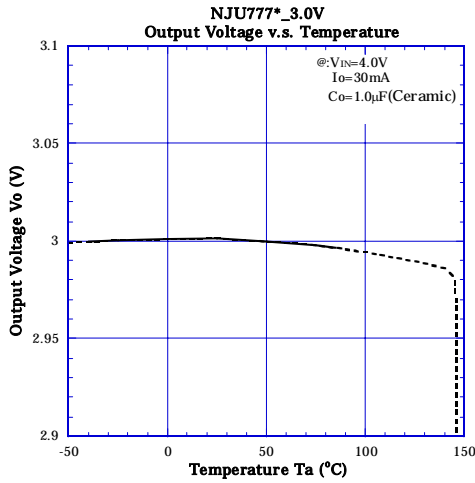
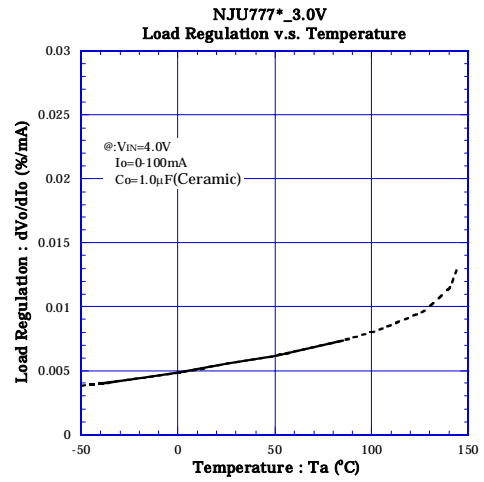
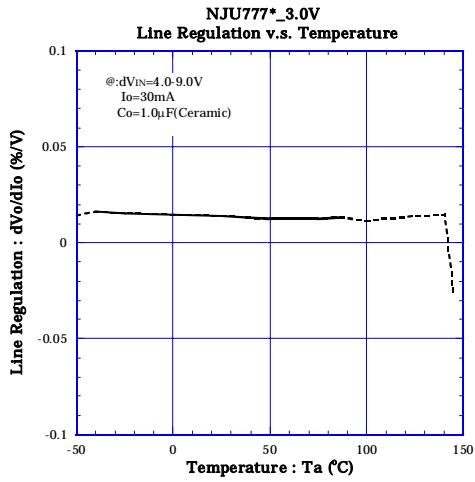

## ■ ELECTRICAL CHARACTERISTICS

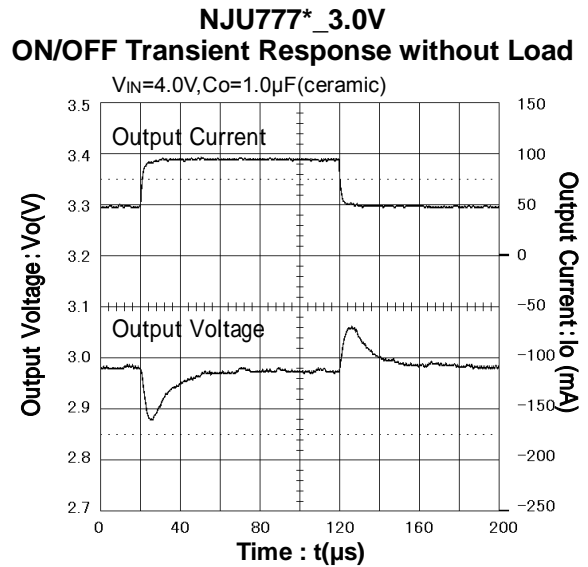
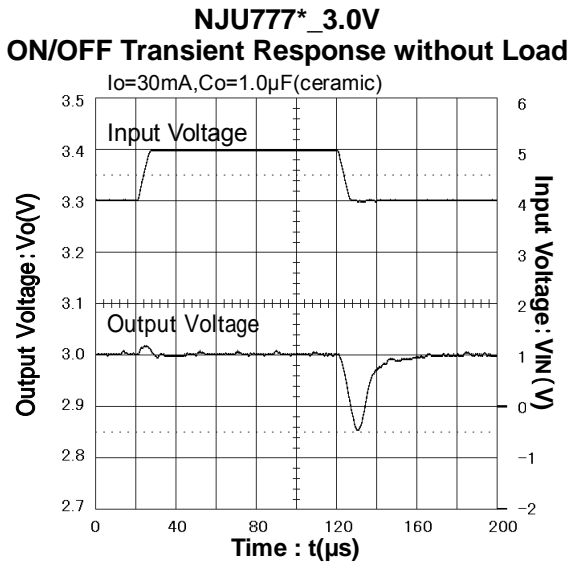
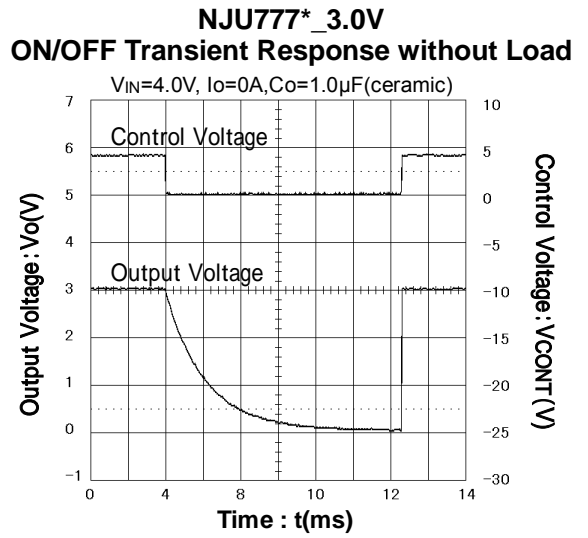
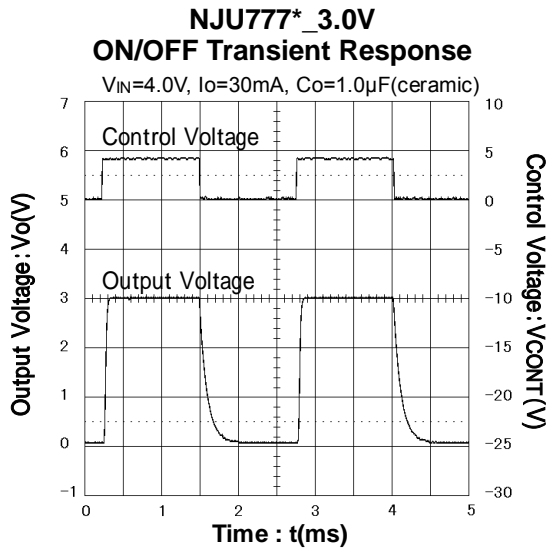



**[CAUTION]**







The specifications on this databook are only given for information, without any guarantee as regards either mistakes or omissions. The application circuits in this databook are described only to show representative usages of the product and not intended for the guarantee or permission of any right including the industrial rights.

## Looking for pricing, stock, or lifecycle information?

Click below to explore more details on WIN SOURCE:

-  [View NJU7772F03\(TE1\) on WIN SOURCE](#)
-  [NJR Corporation/NJRC Information](#)

## Optimize Your Supply Chain with WIN SOURCE Solutions

-  Global Sourcing Solution
-  Obsolete Management
-  Cost Control Management
-  Shortage Management
-  Alternative Solution
-  Excess Inventory Management