



**THE DATASHEET OF
NLV25T-R18J-PF**





Inductors for Standard Circuits

Wound Ferrite

NLV-PF Series

NLV25-PF Type

NLV25-PF

2520 [1008 inch]*

* Dimensions Code JIS[EIA]

Caution

**The products in this catalog is not recommended
to a new design**

Please refer to our Web site about replacement information.

REMINDERS FOR USING THESE PRODUCTS

Before using these products, be sure to request the delivery specifications.

SAFETY REMINDERS

Please pay sufficient attention to the warnings for safe designing when using these products.

⚠ REMINDERS

- The storage period is less than 6 months. Be sure to follow the storage conditions (Temperature: 5 to 40°C, Humidity: 10 to 75% RH or less).
If the storage period elapses, the soldering of the terminal electrodes may deteriorate.
- Do not use or store in locations where there are conditions such as gas corrosion (salt, acid, alkali, etc.).
- Before soldering, be sure to preheat components.
The preheating temperature should be set so that the temperature difference between the solder temperature and chip temperature does not exceed 150°C.
- Soldering corrections after mounting should be within the range of the conditions determined in the specifications.
If overheated, a short circuit, performance deterioration, or lifespan shortening may occur.
- When embedding a printed circuit board where a chip is mounted to a set, be sure that residual stress is not given to the chip due to the overall distortion of the printed circuit board and partial distortion such as at screw tightening portions.
- Self heating (temperature increase) occurs when the power is turned ON, so the tolerance should be sufficient for the set thermal design.
- Carefully lay out the coil for the circuit board design of the non-magnetic shield type.
A malfunction may occur due to magnetic interference.
- Use a wrist band to discharge static electricity in your body through the grounding wire.
- Do not expose the products to magnets or magnetic fields.
- Do not use for a purpose outside of the contents regulated in the delivery specifications.
- The products listed on this catalog are intended for use in general electronic equipment (AV equipment, telecommunications equipment, home appliances, amusement equipment, computer equipment, personal equipment, office equipment, measurement equipment, industrial robots) under a normal operation and use condition.
The products are not designed or warranted to meet the requirements of the applications listed below, whose performance and/or quality require a more stringent level of safety or reliability, or whose failure, malfunction or trouble could cause serious damage to society, person or property.
If you intend to use the products in the applications listed below or if you have special requirements exceeding the range or conditions set forth in the each catalog, please contact us.

- (1) Aerospace/Aviation equipment
- (2) Transportation equipment (cars, electric trains, ships, etc.)
- (3) Medical equipment
- (4) Power-generation control equipment
- (5) Atomic energy-related equipment
- (6) Seabed equipment
- (7) Transportation control equipment

- (8) Public information-processing equipment
- (9) Military equipment
- (10) Electric heating apparatus, burning equipment
- (11) Disaster prevention/crime prevention equipment
- (12) Safety equipment
- (13) Other applications that are not considered general-purpose applications

When designing your equipment even for general-purpose applications, you are kindly requested to take into consideration securing protection circuit/device or providing backup circuits in your equipment.

Inductors for Standard Circuits

Wound Ferrite

Product compatible with RoHS directive
Halogen-free
Compatible with lead-free solders

Overview of NLV25-PF Type

FEATURES

- Resin mold type wound inductor for standard circuits.
- E-12 Series, wide lineup compatible with J ($\pm 5\%$) tolerance, can be used for applications that need to meet strict L tolerance such as filter circuits.
- Has excellent inductance temperature characteristics in the operating temperature range.

APPLICATION

- Smart meters, AV equipment, xDSL, electronic devices for communications infrastructure such as mobile base stations, industrial equipment, other

PART NUMBER CONSTRUCTION

NLV	25	T	-	010	-	J	-	PF	
Series name	LxWxH Dimensions (mm)		Packaging style		Inductance (μH)		Inductance tolerance		Internal code
	25	2.5x2.0x1.8	T	Taping	010	0.01	J	$\pm 5\%$	PF Compatible with the RoHS Directive, Exemption regulations apply
					R10	0.1			
					1R0	1			
					100	10			
					101	100			

OPERATING TEMPERATURE RANGE, PACKAGE QUANTITY, PRODUCT WEIGHT

Type	Temperature range		Package quantity (pieces/reel)	Individual weight (mg)
	Operating temperature* (°C)	Storage temperature** (°C)		
NLV25-PF	-40 to +105	-40 to +105	2000	25

* Operating temperature range includes self-temperature rise.

** The Storage temperature range is for after the circuit board is mounted.

- RoHS Directive Compliant Product: See the following for more details. <https://product.tdk.com/info/en/environment/rohs/index.html>
- Halogen-free: Indicates that Cl content is less than 900ppm, Br content is less than 900ppm, and that the total Cl and Br content is less than 1500ppm.

⚠ Please be sure to request delivery specifications that provide further details on the features and specifications of the products for proper and safe use.
Please note that the contents may change without any prior notice due to reasons such as upgrading.

NLV25-PF Type

RECOMMENDED REFLOW PROFILE



Preheating			Soldering		Peak	
Temp.	Temp.	Time	Temp.	Time	Temp.	Time
T1	T2	t1	T3	t2	T4	t3
150°C	180°C	90 to 120s	230°C	40s	255°C	10s max.

⚠ Please be sure to request delivery specifications that provide further details on the features and specifications of the products for proper and safe use.
Please note that the contents may change without any prior notice due to reasons such as upgrading.

NLV25-PF Type

SHAPE & DIMENSIONS

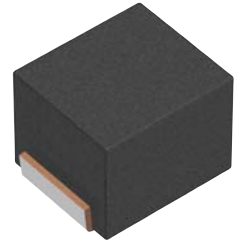

Dimensions in mm

RECOMMENDED LAND PATTERN

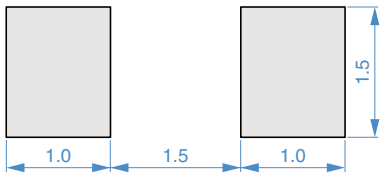

Dimensions in mm

INDUCTORS



NLV25-PF Type

ELECTRICAL CHARACTERISTICS

CHARACTERISTICS SPECIFICATION TABLE

L (μ H)	Q Tolerance	L, Q measuring frequency (MHz)	Self-resonant frequency (MHz)min.	DC resistance (Ω)max.	Rated current* (mA)max.	Part No.	
0.01	$\pm 5\%$	15	100	2150	0.26	530	NLV25T-010J-PF
0.012	$\pm 5\%$	15	100	2050	0.27	500	NLV25T-012J-PF
0.015	$\pm 5\%$	15	100	2000	0.29	480	NLV25T-015J-PF
0.018	$\pm 5\%$	15	100	1850	0.31	450	NLV25T-018J-PF
0.022	$\pm 5\%$	15	100	1650	0.37	420	NLV25T-022J-PF
0.027	$\pm 5\%$	15	100	1550	0.4	410	NLV25T-027J-PF
0.033	$\pm 5\%$	20	100	1450	0.42	400	NLV25T-033J-PF
0.039	$\pm 5\%$	20	100	1350	0.45	380	NLV25T-039J-PF
0.047	$\pm 5\%$	20	100	1200	0.5	360	NLV25T-047J-PF
0.056	$\pm 5\%$	20	100	1100	0.6	340	NLV25T-056J-PF
0.068	$\pm 5\%$	20	100	1050	0.65	320	NLV25T-068J-PF
0.082	$\pm 5\%$	20	100	900	0.75	300	NLV25T-082J-PF
0.1	$\pm 5\%$	20	100	800	0.8	280	NLV25T-R10J-PF
0.12	$\pm 5\%$	30	25.2	700	0.3	550	NLV25T-R12J-PF
0.15	$\pm 5\%$	30	25.2	550	0.35	500	NLV25T-R15J-PF
0.18	$\pm 5\%$	30	25.2	500	0.4	460	NLV25T-R18J-PF
0.22	$\pm 5\%$	30	25.2	450	0.5	430	NLV25T-R22J-PF
0.27	$\pm 5\%$	30	25.2	425	0.55	420	NLV25T-R27J-PF
0.33	$\pm 5\%$	30	25.2	400	0.6	400	NLV25T-R33J-PF
0.39	$\pm 5\%$	30	25.2	375	0.65	375	NLV25T-R39J-PF
0.47	$\pm 5\%$	30	25.2	350	0.68	350	NLV25T-R47J-PF
0.56	$\pm 5\%$	30	25.2	325	0.75	325	NLV25T-R56J-PF
0.68	$\pm 5\%$	30	25.2	300	0.85	300	NLV25T-R68J-PF
0.82	$\pm 5\%$	30	25.2	260	1	260	NLV25T-R82J-PF
1	$\pm 5\%$	30	7.96	245	1.1	245	NLV25T-1R0J-PF
1.2	$\pm 5\%$	30	7.96	230	1.2	230	NLV25T-1R2J-PF
1.5	$\pm 5\%$	30	7.96	182	1.3	220	NLV25T-1R5J-PF
1.8	$\pm 5\%$	30	7.96	135	1.45	210	NLV25T-1R8J-PF
2.2	$\pm 5\%$	30	7.96	105	1.55	200	NLV25T-2R2J-PF
2.7	$\pm 5\%$	30	7.96	70	1.7	195	NLV25T-2R7J-PF
3.3	$\pm 5\%$	30	7.96	55	1.9	185	NLV25T-3R3J-PF
3.9	$\pm 5\%$	30	7.96	48	2.1	180	NLV25T-3R9J-PF
4.7	$\pm 5\%$	30	7.96	43	2.3	175	NLV25T-4R7J-PF
5.6	$\pm 5\%$	25	7.96	42	2.5	170	NLV25T-5R6J-PF
6.8	$\pm 5\%$	25	7.96	39	2.7	165	NLV25T-6R8J-PF
8.2	$\pm 5\%$	25	7.96	36	3.05	160	NLV25T-8R2J-PF
10	$\pm 5\%$	25	2.52	33	3.5	155	NLV25T-100J-PF
12	$\pm 5\%$	25	2.52	30	3.8	150	NLV25T-120J-PF
15	$\pm 5\%$	25	2.52	26	4.4	140	NLV25T-150J-PF
18	$\pm 5\%$	25	2.52	24	4.8	130	NLV25T-180J-PF
22	$\pm 5\%$	25	2.52	22	5.5	125	NLV25T-220J-PF
27	$\pm 5\%$	25	2.52	21	6.3	115	NLV25T-270J-PF
33	$\pm 5\%$	25	2.52	20	7.1	110	NLV25T-330J-PF
39	$\pm 5\%$	20	2.52	18	9.5	90	NLV25T-390J-PF
47	$\pm 5\%$	20	2.52	17	11.1	80	NLV25T-470J-PF
56	$\pm 5\%$	20	2.52	16	12.1	75	NLV25T-560J-PF
68	$\pm 5\%$	20	2.52	15	16.6	70	NLV25T-680J-PF
82	$\pm 5\%$	20	2.52	13	19	66	NLV25T-820J-PF
100	$\pm 5\%$	15	0.796	12	21	60	NLV25T-101J-PF

* Rated current: smaller value of either I_{dc1} or I_{dc2}.

I_{dc1}: When based on the inductance change rate (10% below the initial L value)

I_{dc2}: When based on the temperature increase (Temperature increase of 20°C by self heating)

Measurement equipment

Measurement item	Product No.	Manufacturer
L, Q	4191A+16092A 4194A+16085A+16093B	Keysight Technologies
Self-resonant frequency	8753C	Keysight Technologies
DC resistance	VP-2941A	Panasonic

* Equivalent measurement equipment may be used.

INDUCTORS



NLV25-PF Type

ELECTRICAL CHARACTERISTICS

□ L FREQUENCY CHARACTERISTICS GRAPH



○ Measurement equipment

Product No.	Manufacturer
4291A	Keysight Technologies
4294A	Keysight Technologies

* Equivalent measurement equipment may be used.

⚠ Please be sure to request delivery specifications that provide further details on the features and specifications of the products for proper and safe use. Please note that the contents may change without any prior notice due to reasons such as upgrading.

INDUCTORS



NLV25-PF Type

ELECTRICAL CHARACTERISTICS

Q FREQUENCY CHARACTERISTICS GRAPH

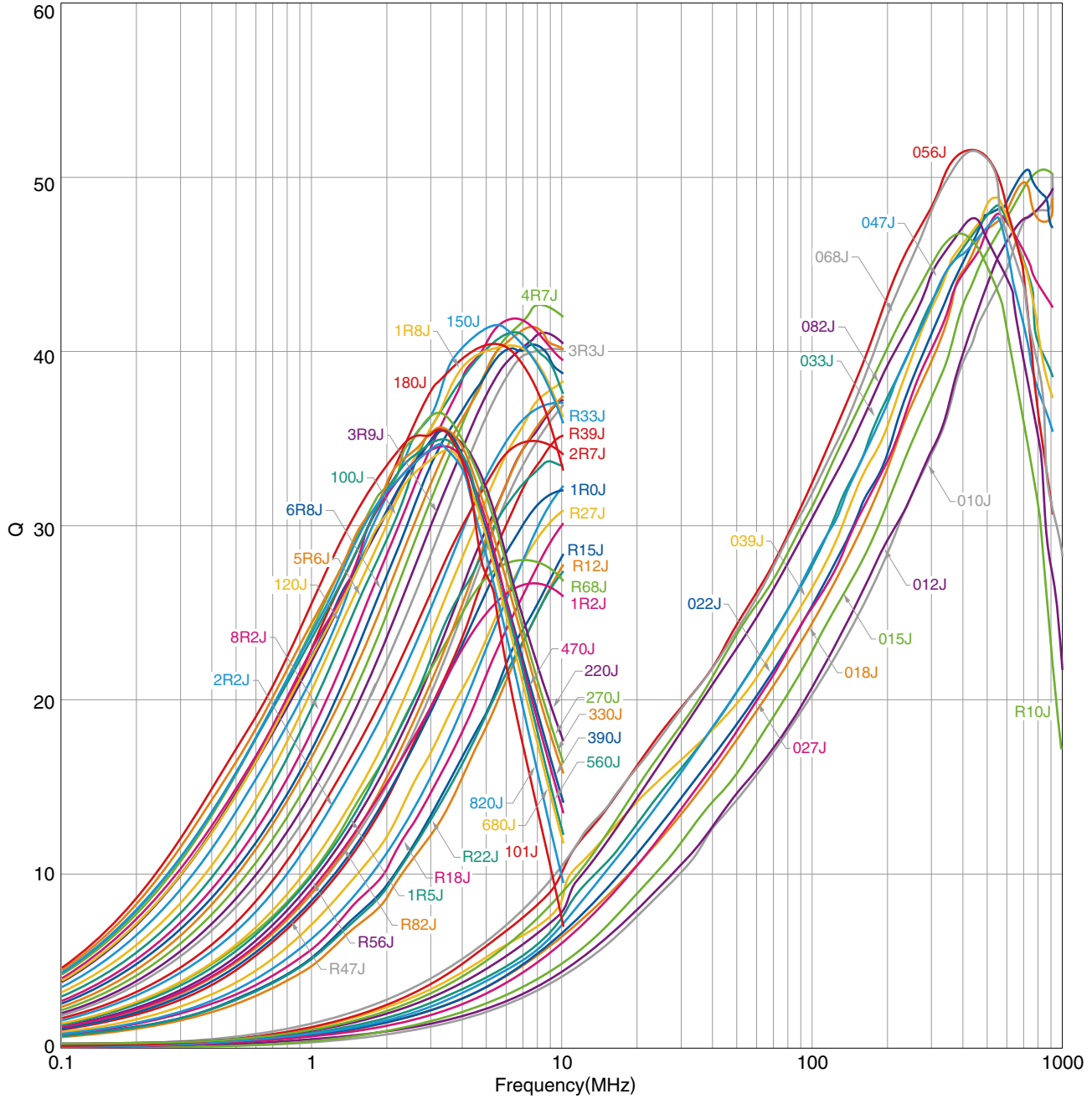

○ Measurement equipment

Product No.	Manufacturer
4291A	Keysight Technologies
4294A	Keysight Technologies

* Equivalent measurement equipment may be used.

⚠ Please be sure to request delivery specifications that provide further details on the features and specifications of the products for proper and safe use. Please note that the contents may change without any prior notice due to reasons such as upgrading.

NLV25-PF Type

PACKAGING STYLE

REEL DIMENSIONS

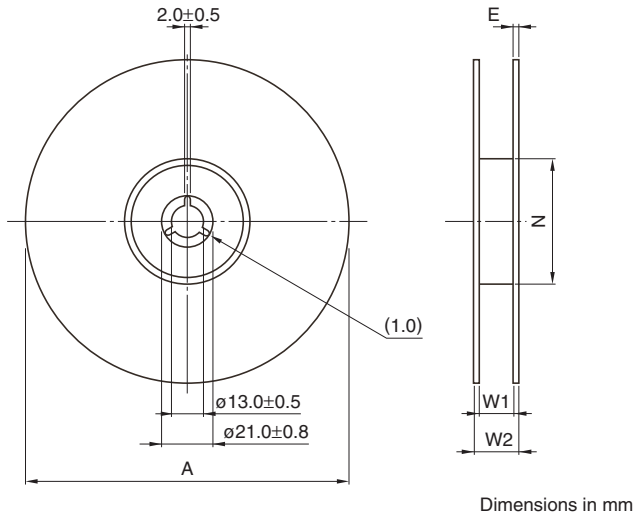

Type	A	W1	W2	N	E
NLV25-PF	$\phi 180$	9	13	$\phi 60$	0.5

* These values are typical values.

Dimensions in mm

TAPE DIMENSIONS

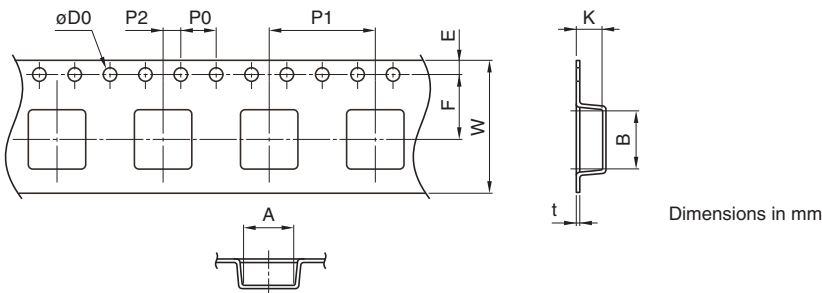



Dimensions in mm

Type	A	B	$\phi D0$	E	F	P0	P1	P2	W	K	t
NLV25-PF	2.3	2.7	$1.5 + 0.1 / - 0$	1.75 ± 0.1	3.50 ± 0.05	4.00 ± 0.10	4.00 ± 0.10	2.00 ± 0.05	8.00 ± 0.30	2	0.4

Looking for pricing, stock, or lifecycle information?

Click below to explore more details on WIN SOURCE:

-  [View NLV25T-R18J-PF on WIN SOURCE](#)
-  [TDK Corporation Information](#)

Optimize Your Supply Chain with WIN SOURCE Solutions

-  Global Sourcing Solution
-  Obsolete Management
-  Cost Control Management
-  Shortage Management
-  Alternative Solution
-  Excess Inventory Management