



**THE DATASHEET OF  
NPH10S4803IC**





### FEATURES

- RoHS compliant
- High efficiency to 87%
- Power density up to 1.5Wcm<sup>3</sup>
- UL1950 recognized
- Industry standard pinout
- Surge rating to 12W
- Non latching current limit
- 1.5kV input to output isolation
- Versatile control options
- Continuous rating to 10W at 72°C without heatsink
- Operation to zero load
- Protected against load faults
- Internal over temperature protection
- Uses no electrolytic capacitors
- Fixed frequency
- No external components required

### DESCRIPTION

The NPH10S series of DC-DC converters combines ease of application with versatility. The pin pattern is based on the popular industry standard, but two additional pins may optionally be fitted to provide a variety of features not commonly found on units of this type. High efficiency enables full rating to be achieved in a small package without heat-sinking. Thermally protected against sustained overload. The copper case achieves efficient heat transfer and screening. The product range has been recognised by Underwriters Laboratory (UL) to UL 1950 for operational insulation, file number E151252 applies.



For full details go to [www.murata-ps.com/rohs](http://www.murata-ps.com/rohs)

### SELECTION GUIDE

| Order Code <sup>1</sup> | Nominal Input Voltage | Output Voltage | Output Current | Current Limit <sup>2</sup> (Typ.) | Efficiency | Max. Load Capacitance | MTTF <sup>3</sup> |                                |
|-------------------------|-----------------------|----------------|----------------|-----------------------------------|------------|-----------------------|-------------------|--------------------------------|
|                         | V                     | V              | A              | A                                 | %          | µF                    | kHrs              |                                |
| <b>In Production</b>    |                       |                |                |                                   |            |                       |                   |                                |
| NPH10S2403EiC           | 24                    | 3.4            | 2.94           | 4.3                               | 79         | 470                   | 279               |                                |
| NPH10S2403iC            | 24                    | 3.4            | 2.94           | 4.3                               | 79         | 470                   | 279               |                                |
| NPH10S2405EiC           | 24                    | 5.1            | 1.96           | 3.1                               | 83         | 470                   | 275               |                                |
| NPH10S2405iC            | 24                    | 5.1            | 1.96           | 3.1                               | 83         | 470                   | 275               |                                |
| NPH10S2412EiC           | 24                    | 12.1           | 0.83           | 1.2                               | 86         | 100                   | 259               |                                |
| NPH10S2412iC            | 24                    | 12.1           | 0.83           | 1.2                               | 86         | 100                   | 259               |                                |
| NPH10S2415EiC           | 24                    | 15.1           | 0.67           | 1.1                               | 86         | 47                    | 243               |                                |
| NPH10S2415iC            | 24                    | 15.1           | 0.67           | 1.1                               | 86         | 47                    | 243               |                                |
| NPH10S4803EiC           | 48                    | 3.4            | 2.94           | 4.1                               | 80         | 470                   | 317               |                                |
| NPH10S4803iC            | 48                    | 3.4            | 2.94           | 4.1                               | 80         | 470                   | 317               |                                |
| NPH10S4805EiC           | 48                    | 5.1            | 1.96           | 2.8                               | 83         | 470                   | 312               |                                |
| NPH10S4805iC            | 48                    | 5.1            | 1.96           | 2.8                               | 83         | 470                   | 312               |                                |
| <b>Discontinued</b>     |                       |                |                |                                   |            |                       |                   |                                |
|                         |                       |                |                |                                   |            |                       |                   | <b>Recommended Alternative</b> |
| NPH10S4812EiC           | 48                    | 12.1           | 0.83           | 1.3                               | 86         | 56                    | 291               | UEI15-120-Q48P-C               |
| NPH10S4812iC            | 48                    | 12.1           | 0.83           | 1.3                               | 86         | 56                    | 291               | UEI15-120-Q48P-C               |
| NPH10S4815EiC           | 48                    | 15.1           | 0.67           | 1.0                               | 87         | 22                    | 272               | UEI15-150-Q48P-C               |
| NPH10S4815iC            | 48                    | 15.1           | 0.67           | 1.0                               | 87         | 22                    | 272               | UEI15-150-Q48P-C               |

### INPUT CHARACTERISTICS

| Parameter     | Conditions                                         | Min. | Typ. | Max. | Units |
|---------------|----------------------------------------------------|------|------|------|-------|
| Voltage range | Continuous operation, 24V input types              | 18   | 24   | 36   | V     |
|               | Continuous operation, 48V input types <sup>4</sup> | 36   | 48   | 75   |       |

### OUTPUT CHARACTERISTICS

| Parameter                                         | Conditions                                                                 | Min. | Typ. | Max. | Units |
|---------------------------------------------------|----------------------------------------------------------------------------|------|------|------|-------|
| Voltage set point error                           | 50% load after 30 mins at nominal supply voltage                           |      |      | 0.5  | %     |
| Overall voltage error                             | Case temperature -40°C to 110°C<br>Load 0% - 100%<br>Input specified range |      | 1    | 2.5  | %     |
| Temperature coefficient of output voltage (slope) | Over any 10°C span within the specified temperature range                  |      | 50   | 250  | ppm°C |
| Deviation of output voltage                       | Specified over temperature MIN-MAX                                         |      | 0.5  | 1    | %     |
| Line regulation                                   | Operating voltage range, 50% load                                          |      | 0.05 | 0.1  | %     |
| Load Regulation                                   | 0% - 100% rated load <sup>5</sup>                                          |      |      | 0.5  | %     |
| Ripple                                            | rms                                                                        |      | 70   |      | mV    |

### ABSOLUTE MAXIMUM RATINGS

|                                  |                                                                 |
|----------------------------------|-----------------------------------------------------------------|
| Input voltage, 24V input types   | -0.5V to 40V <sup>6</sup>                                       |
| Input voltage, 48V input types   | -0.5V to 80V <sup>6</sup>                                       |
| Output voltage                   | -0.3V to controlled output voltage (operating or non-operating) |
| Output trim control              | -1V to +30V                                                     |
| Synchronisation/shutdown control | ±15V relative to input return                                   |

1. Parts ending with EiC have optional TRIM and SS pins fitted.
2. Current is quoted when output is 95% of regulated voltage.
3. Calculated using MIL-HDBK-217F with nominal input voltage at full load.
4. For applications requiring UL 1950 recognition, input voltage must not exceed 60VDC.
5. A minimum load of 10% of rating is recommended for typical applications.
6. Absolute maximum value for 30 seconds. Prolonged application may damage the product.  
All specifications typical at T<sub>a</sub>=25°C, nominal input voltage and rated output current unless otherwise specified.

### CONTROL CHARACTERISTICS

| Parameter                                                             | Conditions                                                                    | Min. | Typ. | Max. | Units |
|-----------------------------------------------------------------------|-------------------------------------------------------------------------------|------|------|------|-------|
| Voltage trimming range <sup>1</sup>                                   | At rated load, trim control at either output                                  | ±10  |      |      | %     |
| Remote switch input (voltage relative to input negative) <sup>1</sup> | For shutdown                                                                  | -15  | 0    | 1.5  | V     |
|                                                                       | Operating, open circuit voltage                                               | 9    | 10   | 11   |       |
| Start delay                                                           | Time from application of valid input voltage to output being in specification |      | 25   |      | ms    |
| Synchronisation <sup>1</sup>                                          | Specified drive signal                                                        | 320  |      | 440  | kHz   |
| Switching frequency                                                   |                                                                               | 330  | 350  | 395  | kHz   |

### ISOLATION CHARACTERISTICS

| Parameter              | Conditions                | Min. | Typ. | Max. | Units |
|------------------------|---------------------------|------|------|------|-------|
| Isolation test voltage | Flash tested for 1 second | 1500 |      |      | VDC   |
| Resistance             | VISO = 500VDC             | 1    |      |      | GΩ    |
| Capacitance            | 3.3V and 5V output        |      | 50   |      | pF    |
|                        | 12V and 15V output        |      | 90   |      |       |

### TEMPERATURE CHARACTERISTICS

| Parameter          | Conditions                         | Min. | Typ. | Max. | Units |
|--------------------|------------------------------------|------|------|------|-------|
| Case temperature   | Full load                          | -40  |      | 110  | °C    |
| Storage            | Absolute Max. internal temperature | -40  |      | 125  |       |
| Relative humidity  | Non condensing 85°C                |      |      | 85   | %     |
| Thermal protection | Operates at case temperature       | 110  |      |      | °C    |

### THERMAL CHARACTERISTICS

**Max. power rating** with case temperature maintained by external means (e.g. forced air cooling).

| Part Number   | Case Temperature |       |       | Units |
|---------------|------------------|-------|-------|-------|
|               | 100°C            | 105°C | 110°C |       |
| NPH20S2403XXX | 10               | 7.0   | 2.3   | W     |
| NPH10S2405XXX | 10               | 8.2   | 3.0   |       |
| NPH10S2412XXX | 10               | 9.5   | 4.0   |       |
| NPH10S2415XXX | 12               | 9.5   | 4.0   |       |
| NPH10S4803XXX | 10               | 7.0   | 1.0   | W     |
| NPH10S4805XXX | 10               | 4.7   | 1.0   |       |
| NPH10S4812XXX | 12               | 8.0   | 0     |       |
| NPH10S4815XXX | 12               | 7.5   | 0     |       |

### THERMAL PERFORMANCE

24V Input

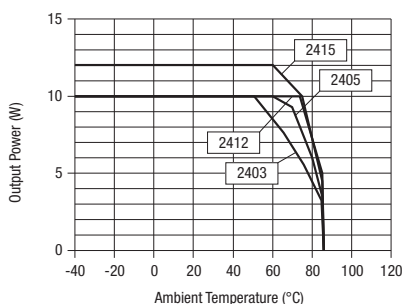

48V Input

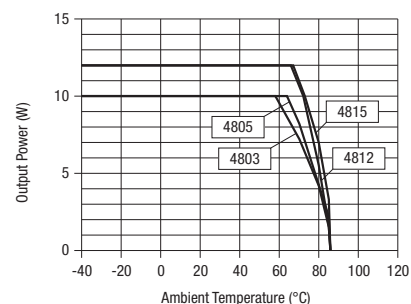

1. Optional - where fitted.

**APPLICATION NOTES**

**OUTPUT VOLTAGE ADJUSTMENT**

The trim resistor equations are:

$$R_{up} = (R/V_{up}) - S \text{ k}\Omega$$

$$R_{down} = (L \times \frac{T}{V_{down}}) - T - S \text{ k}\Omega$$

| V <sub>NOM</sub> | 3.4     | 5.1      | 12.1      | 15.1      |
|------------------|---------|----------|-----------|-----------|
| S                | 22.2973 | 20.59761 | 28.79096  | 39.95902  |
| T                | 10.1351 | 9.36255  | 15.42373  | 20.77869  |
| R                | 17.9994 | 24.49487 | 94.9661   | 147.7314  |
| L                | -1.6241 | -2.48374 | -5.942857 | -7.990244 |

**TRIM UP**

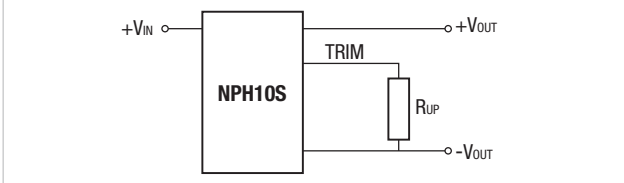

**TRIM DOWN**

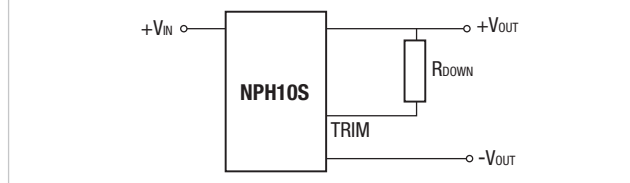

When the output voltage is trimmed up, output current must be derated so that the maximum output power 10W is not exceeded.

Example to decrease output voltage of NPH10S4805EiC by 0.1V:  $R_{DOWN} = \left( \frac{-2.48374 \times 9.36255}{-0.1} \right) - 9.36255 - 20.59761 = 203.18\text{k}\Omega$

**SET VOLTAGE**

The output voltage of all units is set to 100mV above nominal, to offset resistive losses and thus assist with worst case error calculations. For the EiC versions, this allowance can be altered with a single fixed resistor, connected from the trimming pin to one of the output pins.

**SHUTDOWN**

When the shutdown pin (SS) is shorted to the negative input, the converter will stop. Its current consumption will then be less than 1mA at nominal supply voltage. The voltage must be less than 1.5V to ensure that the unit stops, and must be able to sink at least 1mA.

The unit will restart if the control pin is left open circuit or raised to a value close to its normal open circuit voltage. This is typically 10V. Note however, that the unit will not meet specification while a significant current drain from this pin remains.

If the shutdown pin is to be connected to a long wire, it is recommended that a capacitor decouples the pin to the supply common in order to avoid the risk of injecting noise into the converter circuit. A series resistor may also be helpful. Values of 10nF and 1kΩ may be used.

Many NPH series converters may be switched together simply by linking the primary control pins. The primary common pins must also be linked.

**FREQUENCY CONTROL**

If the primary side dc control voltage is pulled away from its open circuit voltage, the converter frequency will be changed, approximately in proportion to the voltage. With +8.5VDC voltage to SS pin, the typical switching frequency will be 300kHz. If this is raised to 15VDC, the switching frequency will typically be 510kHz. The frequency may thus be moved away from a sensitive value or into a safe area. Deviation of at least -10% to 30% is achievable, though the efficiency will decline with significant changes. Also note that if the frequency is lowered, the switching frequency component of output ripple will increase. Since the design uses no large electrolytic capacitors, any use of a lower frequency must allow for the effects of increased ripple. Additional external filtering may be required.

**APPLICATION NOTES (continued)**

**SYNCHRONISATION**

The converter frequency may be synchronised to an external frequency by connecting a negative going pulse to the SS pin. The drive signal is typically 8V to 12V amplitude and 100ns to 200ns duration. A suitable circuit consists of a CMOS timer (TLC555) connected as an oscillator or as a pulse shaper. Its logic output (not the discharge output) should be connected via a 4.7nF capacitor to the converter pin. The synchronised frequency is above the free running value. However, the free running frequency can be lowered, so that synchronisation may include frequencies near or below the natural value. An example of a practical circuit is shown below, which uses a zener diode to lower the natural frequency. Several converters of this family may be synchronised from the same reference provided the waveform can be maintained by the use of an adequate driver circuit. If the rise time is more than 20ns, for example, synchronisation may not be achieved over the specified frequency range.

For best efficiency, set the frequency within the specified range of its natural state.

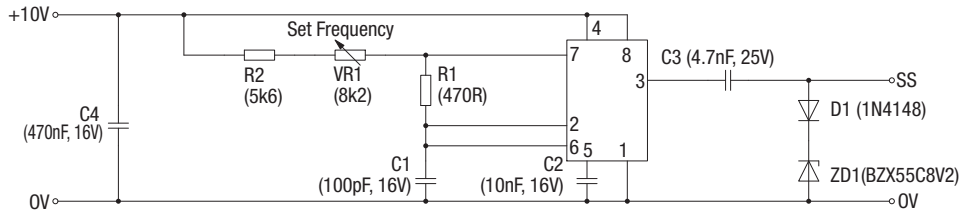

**TECHNICAL NOTES**

**ISOLATION VOLTAGE**

'Hi Pot Test', 'Flash Tested', 'Withstand Voltage', 'Proof Voltage', 'Dielectric Withstand Voltage' & 'Isolation Test Voltage' are all terms that relate to the same thing, a test voltage, applied for a specified time, across a component designed to provide electrical isolation, to verify the integrity of that isolation.

Murata Power Solutions NPH10S series of DC-DC converters are all 100% production tested at their stated isolation voltage. This is 1500V DC for 1 second.

A question commonly asked is, "What is the continuous voltage that can be applied across the part in normal operation?"

The NPH10S series has been recognized by Underwriters Laboratory, both input and output should normally be maintained within SELV limits i.e. less than 42.4V peak, or 60VDC. The isolation test voltage represents a measure of immunity to transient voltages and the part should never be used as an element of a safety isolation system. The part could be expected to function correctly with several hundred volts offset applied continuously across the isolation barrier; but then the circuitry on both sides of the barrier must be regarded as operating at an unsafe voltage and further isolation/insulation systems must form a barrier between these circuits and any user-accessible circuitry according to safety standard requirements.

**REPEATED HIGH-VOLTAGE ISOLATION TESTING**

It is well known that repeated high-voltage isolation testing of a barrier component can actually degrade isolation capability, to a lesser or greater degree depending on materials, construction and environment. While manufactured parts can withstand several times the stated test voltage, the isolation capability does depend on the wire insulation. Any material, including this enamel (typically polyurethane) is susceptible to eventual chemical degradation when subject to very high applied voltages thus implying that the number of tests should be strictly limited. We therefore strongly advise against repeated high voltage isolation testing, but if it is absolutely required, that the voltage be reduced by 20% from specified test voltage.

**EMC FILTERING AND SPECTRA**

**FILTERING**

The module includes a basic level of filtering, sufficient for many applications. Where lower noise levels are desired, filters can easily be added to achieve any required noise performance.

A DC-DC converter generates noise in two principle forms: that which is radiated from its body and that conducted on its external connections. There are three separate modes of conducted noise: input differential, output differential and input-output.

This last appears as common mode at the input and the output, and cannot therefore be removed by filtering at the input or output alone. The first level of filtering is to connect a capacitor between input and output returns, to reduce this form of noise. It typically contains high harmonics of the switching frequency, which tend to appear as spikes on surrounding circuits. The voltage rating of this capacitor must match the required isolation voltage. (Due to the great variety in isolation voltage and required noise performance, this capacitor has not been included within the converter.)

Input ripple is a voltage developed across the internal Input decoupling capacitor. It is therefore measured with a defined supply source impedance. Although simple series inductance will provide filtering, on its own it can degrade the stability. A shunt capacitor is therefore recommended across the converter input terminals, so that it is fed from a low impedance.

If no filtering is required, the inductance of long supply wiring could also cause a problem, requiring an input decoupling capacitor for stability. An electrolytic will perform well in these situations. The input-output filtering is performed by the common-mode choke on the primary. This could be placed on the output, but would then degrade the regulation and produce less benefit for a given size, cost, and power loss.

Radiated noise is present in magnetic and electrostatic forms. The latter is suppressed by the metal case, which is connected to the output return, typically a zero-volt point. Thanks to the small size of these units, neither form of noise will be radiated "efficiently", so will not normally cause a problem. Any question of this kind usually better repays attention to conducted signals.

**EMC FILTER AND VALUES TO OBTAIN SPECTRA AS SHOWN**

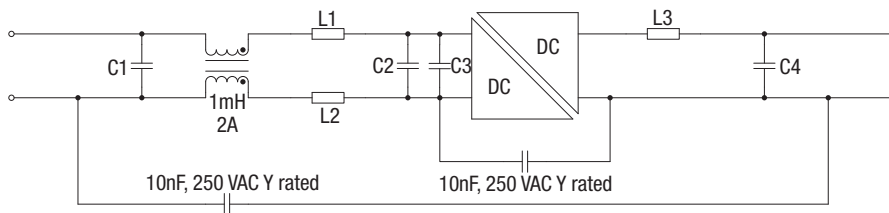

|            | Component reference |              |              |          |    |                           |                            |
|------------|---------------------|--------------|--------------|----------|----|---------------------------|----------------------------|
|            | C1                  | C2           | C3           | C4       | L1 | L2                        | L3                         |
| NPH10S2403 | 10µF 100V           | 47µF 63V     | 2.2µF 63V    | 10µF 25V |    | MPS 18R333C<br>33µH 2A    | MPS 18R472C<br>4.7µH 5.35A |
| NPH10S2405 | 10µF 100V           | 47µF 63V     | 2.2µF 63V    | 10µF 25V |    | MPS 18R333C<br>33µH 2A    | MPS 18R103C<br>10µH 3.45A  |
| NPH10S2412 | 10µF 100V           | Not required | 470nF 63V    | 10µF 25V |    | MPS 18R333C<br>33µH 2A    | MPS 18R333C<br>33µH 2.00A  |
| NPH10S2415 | 10µF 100V           | 10µF 63V     | Not required | 10µF 25V |    | MPS 18R473C<br>47µH 1.65A | MPS 18R333C<br>33µH 2.00A  |
| NPH10S4803 | 10µF 100V           | 47µF 100V    | 220nF 100V   | 10µF 25V |    | MPS 18R104C<br>100µH 1.2A | MPS 18R472C<br>4.7µH 5.35A |
| NPH10S4805 | 10µF 100V           | 47µF 100V    | 220nF 100V   | 10µF 25V |    | MPS 18R104C<br>100µH 1.2A | MPS 18R103C<br>10µH 3.45A  |
| NPH10S4812 | 10µF 100V           | Not required | 470nF 100V   | 10µF 25V |    | MPS 18R104C<br>100µH 1.2A | MPS 18R333C<br>33µH 2.00A  |
| NPH10S4815 | 10µF 100V           | Not required | 470nF 100V   | 10µF 25V |    | MPS 18R104C<br>100µH 1.2A | MPS 18R333C<br>33µH 2.00A  |

C1, C2 & C4 : Electrolytic capacitors  
 C3 : Polyester or ceramic capacitor  
 EMC Spectra red limit line is EN 55022 curve B Quasi-peak average limit.

**EMC FILTERING AND SPECTRA (continued)**

**NPH10S2403**

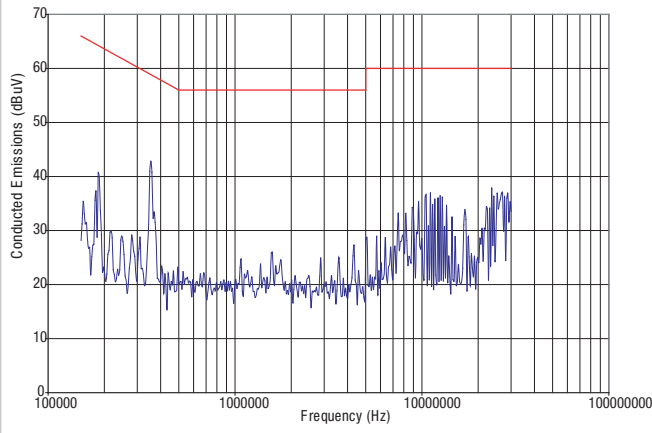

**NPH10S2405**

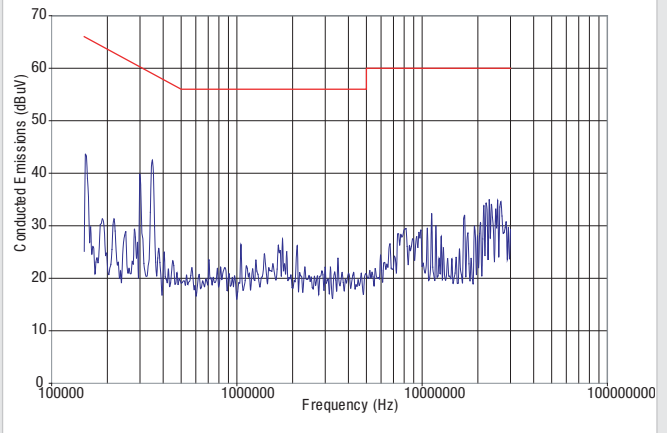

**NPH10S2412**

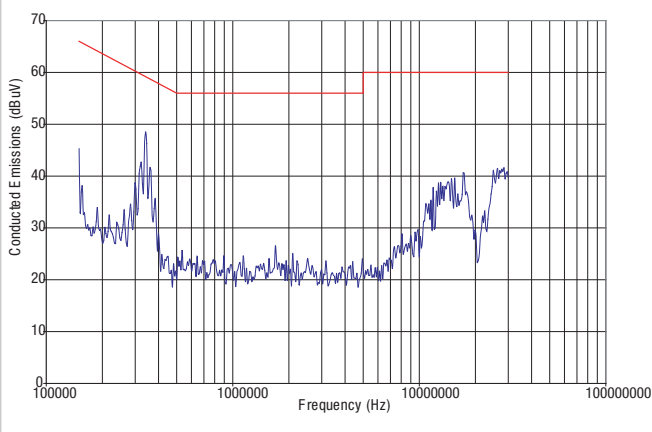

**NPH10S2415**

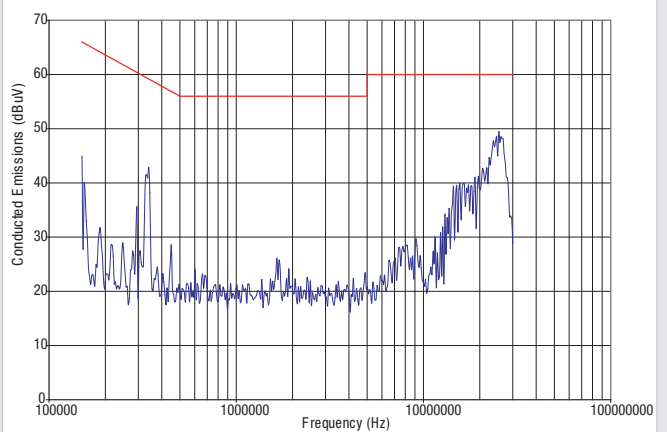

**NPH10S4803**

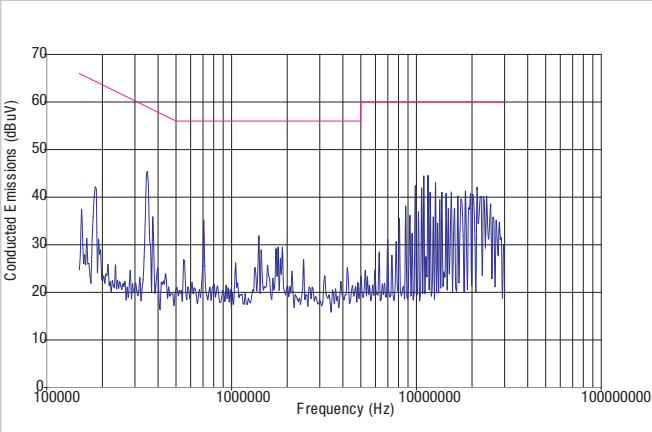

**NPH10S4805**

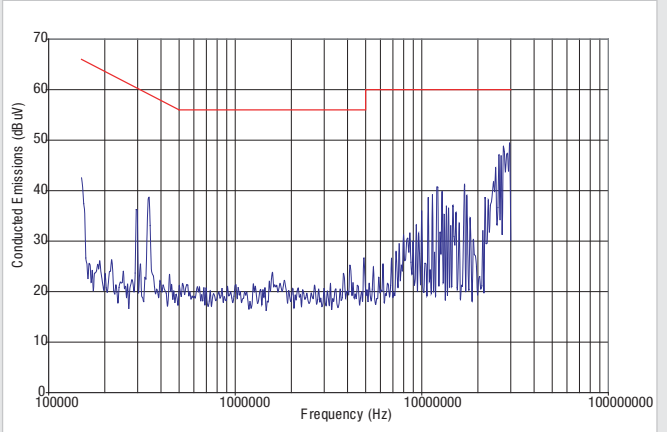

**EMC FILTERING AND SPECTRA (continued)**

**NPH10S4812**

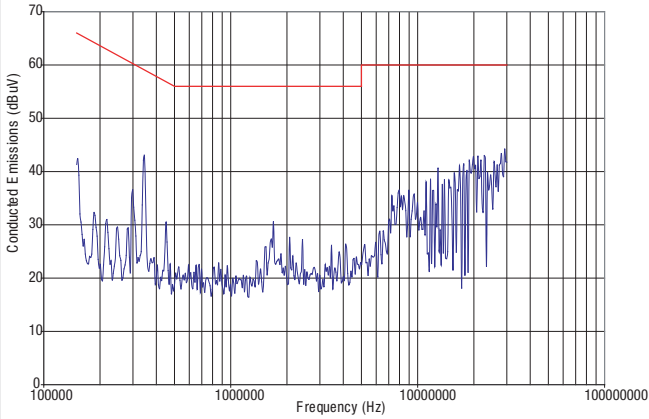

**NPH10S4815**

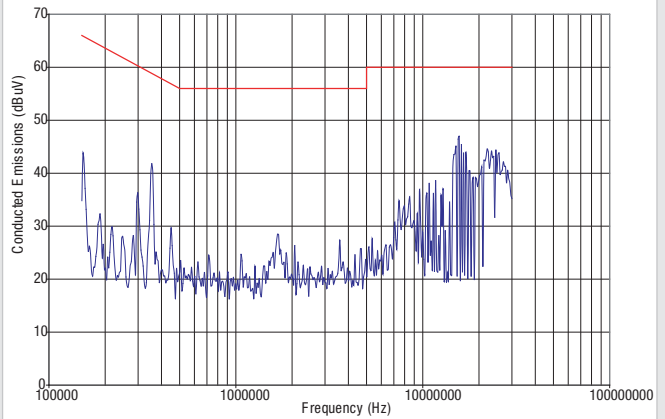

**RoHS COMPLIANCE INFORMATION**



This series is compatible with RoHS soldering systems with a peak wave solder temperature of 260°C for 10 seconds. The pin termination finish on this product series is a Gold flash (0.05-0.10 micron) over Nickel Preplate. The series is backward compatible with Sn/Pb soldering systems. For further information, please visit [www.murata-ps.com/rohs](http://www.murata-ps.com/rohs)

**PACKAGE SPECIFICATIONS**

**MECHANICAL DIMENSIONS**

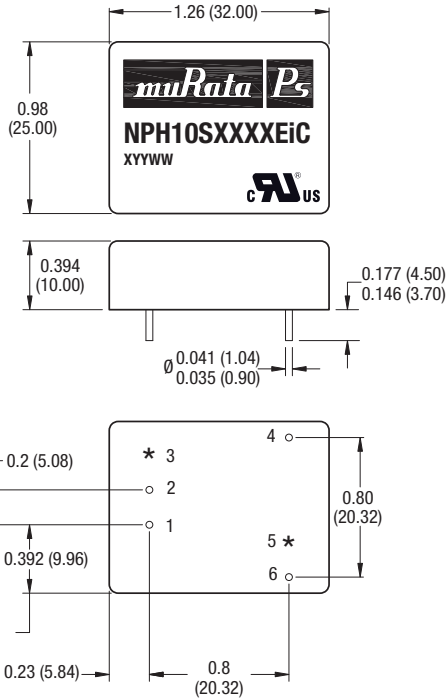

Weight: 22g

All dimensions in inches  $\pm 0.01$  (mm  $\pm 0.25$ mm)

All pins on a 0.10 (2.54) pitch and within  $\pm 0.01$  (0.254) of true position

\* Optional control pins

The copper case is connected to the output (-V<sub>OUT</sub>) pin. Care is needed in the design of this circuit board on which the converter is mounted. Top side tracks must not contact the edge of the case on the underside of the unit.

Please note that from 2010 onwards you may receive either a blue or a black case finish.

**PIN CONNECTIONS**

| Pin | Function          |
|-----|-------------------|
| 1   | -V <sub>IN</sub>  |
| 2   | +V <sub>IN</sub>  |
| 3*  | SS                |
| 4   | +V <sub>OUT</sub> |
| 5*  | TRIM              |
| 6   | -V <sub>OUT</sub> |

\* Optional pins

**RECOMMENDED FOOTPRINT DETAILS**

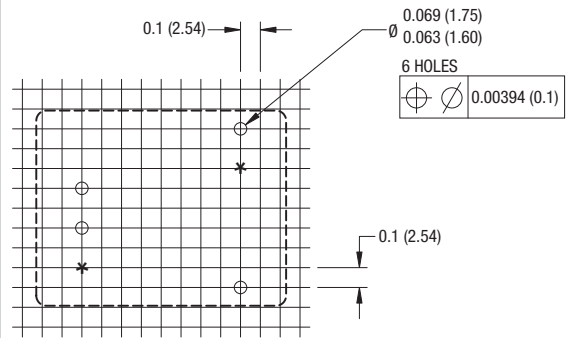

All dimensions in inches  $\pm 0.01$  (mm  $\pm 0.25$ mm)

\* Optional control pins

**TUBE OUTLINE DIMENSIONS**

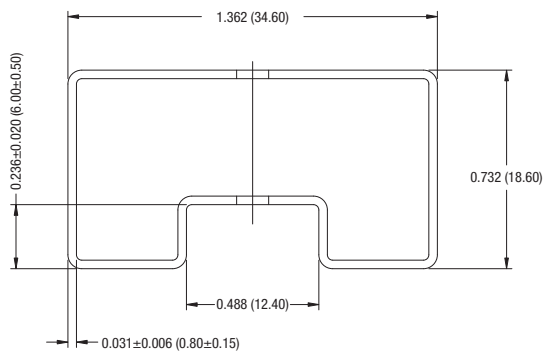

All dimensions in inches  $\pm 0.01$  (mm  $\pm 0.25$ mm)

Tube length: 20.866 (530)  $\pm 2$  (0.079)

Tube material: Antistatic coated clear PVC

Tube Quantity: 15



This product is subject to the following **operating requirements** and the **Life and Safety Critical Application Sales Policy**:



Refer to: <http://www.murata-ps.com/requirements/>

Murata Power Solutions, Inc. makes no representation that the use of its products in the circuits described herein, or the use of other technical information contained herein, will not infringe upon existing or future patent rights. The descriptions contained herein do not imply the granting of licenses to make, use, or sell equipment constructed in accordance therewith. Specifications are subject to change without notice.

©2018 Murata Power Solutions, Inc.

## Looking for pricing, stock, or lifecycle information?

Click below to explore more details on WIN SOURCE:

-  [View NPH10S4803IC on WIN SOURCE](#)
-  [Murata Power Solutions Inc. Information](#)

## Optimize Your Supply Chain with WIN SOURCE Solutions

-  Global Sourcing Solution
-  Obsolete Management
-  Cost Control Management
-  Shortage Management
-  Alternative Solution
-  Excess Inventory Management