



# NTD3055-150, NVD3055-150

## MOSFET – Power, N-Channel, DPAK/IPAK 9.0 A, 60 V

Designed for low voltage, high speed switching applications in power supplies, converters and power motor controls and bridge circuits.

### Features

- NVD Prefix for Automotive and Other Applications Requiring Unique Site and Control Change Requirements; AEC-Q101 Qualified and PPAP Capable
- These Devices are Pb-Free and are RoHS Compliant

### Typical Applications

- Power Supplies
- Converters
- Power Motor Controls
- Bridge Circuits

### MAXIMUM RATINGS (T<sub>J</sub> = 25°C unless otherwise noted)

Rating	Symbol	Value	Unit
Drain-to-Source Voltage	V <sub>DSS</sub>	60	Vdc
Drain-to-Gate Voltage (R <sub>GS</sub> = 10 MΩ)	V <sub>DGR</sub>	60	Vdc
Gate-to-Source Voltage	V <sub>GS</sub>	±20	Vdc
– Continuous	V <sub>GS</sub>	±30	Vdc
– Non-repetitive (t <sub>p</sub> ≤ 10 ms)			
Drain Current	I <sub>D</sub>	9.0	Adc
– Continuous @ T <sub>A</sub> = 25°C	I <sub>D</sub>	3.0	
– Continuous @ T <sub>A</sub> = 100°C	I <sub>DM</sub>	27	Apk
– Single Pulse (t <sub>p</sub> ≤ 10 μs)			
Total Power Dissipation @ T <sub>A</sub> = 25°C	P <sub>D</sub>	28.8	W
Derate above 25°C		0.19	W/°C
Total Power Dissipation @ T <sub>A</sub> = 25°C (Note 1)		2.1	W
Total Power Dissipation @ T <sub>A</sub> = 25°C (Note 2)		1.5	W
Operating and Storage Temperature Range	T <sub>J</sub> , T <sub>stg</sub>	–55 to 175	°C
Single Pulse Drain-to-Source Avalanche Energy – Starting T <sub>J</sub> = 25°C (V <sub>DD</sub> = 25 Vdc, V <sub>GS</sub> = 10 Vdc, L = 1.0 mH, I <sub>L(pk)</sub> = 7.75 A, V <sub>DS</sub> = 60 Vdc)	E <sub>AS</sub>	30	mJ
Thermal Resistance	R <sub>θJC</sub>	5.2	°C/W
– Junction-to-Case	R <sub>θJA</sub>	71.4	
– Junction-to-Ambient (Note 1)	R <sub>θJA</sub>	100	
– Junction-to-Ambient (Note 2)			
Maximum Lead Temperature for Soldering Purposes, 1/8" from case for 10 seconds	T <sub>L</sub>	260	°C

Stresses exceeding those listed in the Maximum Ratings table may damage the device. If any of these limits are exceeded, device functionality should not be assumed, damage may occur and reliability may be affected.

1. When surface mounted to an FR4 board using 0.5 sq in pad size.
2. When surface mounted to an FR4 board using minimum recommended pad size.



ON Semiconductor®

[www.onsemi.com](http://www.onsemi.com)

9.0 AMPERES, 60 VOLTS  
R<sub>DS(on)</sub> = 122 mΩ (Typ)

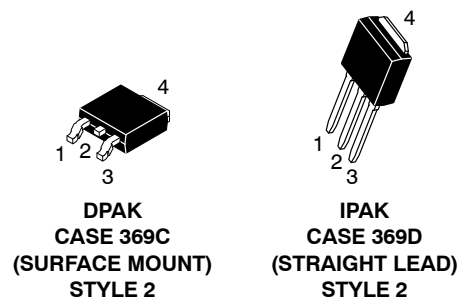
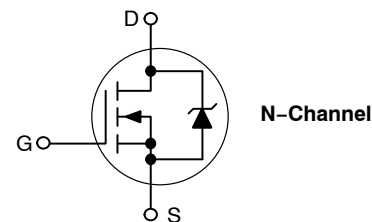

### MARKING DIAGRAMS & PIN ASSIGNMENTS

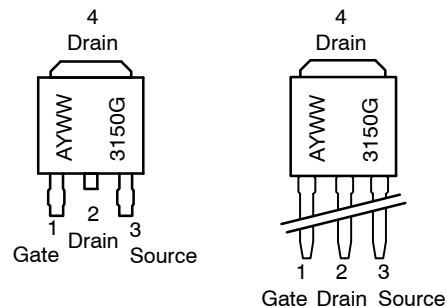

A = Assembly Location\*  
3150 = Device Code  
Y = Year  
WW = Work Week  
G = Pb-Free Package

\* The Assembly Location code (A) is front side optional. In cases where the Assembly Location is stamped in the package, the front side assembly code may be blank.

### ORDERING INFORMATION

See detailed ordering and shipping information in the package dimensions section on page 5 of this data sheet.

# NTD3055-150, NVD3055-150

## ELECTRICAL CHARACTERISTICS (T<sub>J</sub> = 25°C unless otherwise noted)

Characteristic	Symbol	Min	Typ	Max	Unit
<b>OFF CHARACTERISTICS</b>					
Drain-to-Source Breakdown Voltage (Note 3) (V <sub>GS</sub> = 0 Vdc, I <sub>D</sub> = 250 μAdc) Temperature Coefficient (Positive)	V <sub>(BR)DSS</sub>	60 -	- 70.2	- -	Vdc mV/°C
Zero Gate Voltage Drain Current (V <sub>DS</sub> = 60 Vdc, V <sub>GS</sub> = 0 Vdc) (V <sub>DS</sub> = 60 Vdc, V <sub>GS</sub> = 0 Vdc, T <sub>J</sub> = 150°C)	I <sub>DSS</sub>	- -	- -	1.0 10	μAdc
Gate-Body Leakage Current (V <sub>GS</sub> = ±20 Vdc, V <sub>DS</sub> = 0 Vdc)	I <sub>GSS</sub>	-	-	±100	nAdc

## ON CHARACTERISTICS (Note 3)

Gate Threshold Voltage (Note 3) (V <sub>DS</sub> = V <sub>GS</sub> , I <sub>D</sub> = 250 μAdc) Threshold Temperature Coefficient (Negative)	V <sub>GS(th)</sub>	2.0 -	3.0 6.4	4.0 -	Vdc mV/°C
Static Drain-to-Source On-Resistance (Note 3) (V <sub>GS</sub> = 10 Vdc, I <sub>D</sub> = 4.5 Adc)	R <sub>DS(on)</sub>	-	122	150	mΩ
Static Drain-to-Source On-Voltage (Note 3) (V <sub>GS</sub> = 10 Vdc, I <sub>D</sub> = 9.0 Adc) (V <sub>GS</sub> = 10 Vdc, I <sub>D</sub> = 4.5 Adc, T <sub>J</sub> = 150°C)	V <sub>DS(on)</sub>	- -	1.4 1.1	1.9 -	Vdc
Forward Transconductance (Note 3) (V <sub>DS</sub> = 7.0 Vdc, I <sub>D</sub> = 6.0 Adc)	g <sub>FS</sub>	-	5.4	-	mhos

## DYNAMIC CHARACTERISTICS

Input Capacitance	(V <sub>DS</sub> = 25 Vdc, V <sub>GS</sub> = 0 Vdc, f = 1.0 MHz)	C <sub>iss</sub>	-	200	280	pF
Output Capacitance		C <sub>oss</sub>	-	70	100	
Transfer Capacitance		C <sub>rss</sub>	-	26	40	

## SWITCHING CHARACTERISTICS (Note 4)

Turn-On Delay Time	(V <sub>DD</sub> = 48 Vdc, I <sub>D</sub> = 9.0 Adc, V <sub>GS</sub> = 10 Vdc, R <sub>G</sub> = 9.1 Ω) (Note 3)	t <sub>d(on)</sub>	-	11.2	25	ns
Rise Time		t <sub>r</sub>	-	37.1	80	
Turn-Off Delay Time		t <sub>d(off)</sub>	-	12.2	25	
Fall Time		t <sub>f</sub>	-	23	50	
Gate Charge	(V <sub>DS</sub> = 48 Vdc, I <sub>D</sub> = 9.0 Adc, V <sub>GS</sub> = 10 Vdc) (Note 3)	Q <sub>T</sub>	-	7.1	15	nC
		Q <sub>1</sub>	-	1.7	-	
		Q <sub>2</sub>	-	3.5	-	

## SOURCE-DRAIN DIODE CHARACTERISTICS

Forward On-Voltage	(I <sub>S</sub> = 9.0 Adc, V <sub>GS</sub> = 0 Vdc) (Note 3) (I <sub>S</sub> = 19 Adc, V <sub>GS</sub> = 0 Vdc, T <sub>J</sub> = 150°C)	V <sub>SD</sub>	- -	0.98 0.86	1.20 -	Vdc
Reverse Recovery Time	(I <sub>S</sub> = 9.0 Adc, V <sub>GS</sub> = 0 Vdc, di <sub>S</sub> /dt = 100 A/μs) (Note 3)	t <sub>rr</sub>	-	28.9	-	ns
		t <sub>a</sub>	-	21.6	-	
		t <sub>b</sub>	-	7.3	-	
Reverse Recovery Stored Charge		Q <sub>RR</sub>	-	0.036	-	μC

Product parametric performance is indicated in the Electrical Characteristics for the listed test conditions, unless otherwise noted. Product performance may not be indicated by the Electrical Characteristics if operated under different conditions.

3. Pulse Test: Pulse Width ≤ 300 μs, Duty Cycle ≤ 2%.

4. Switching characteristics are independent of operating junction temperatures.

# NTD3055-150, NVD3055-150

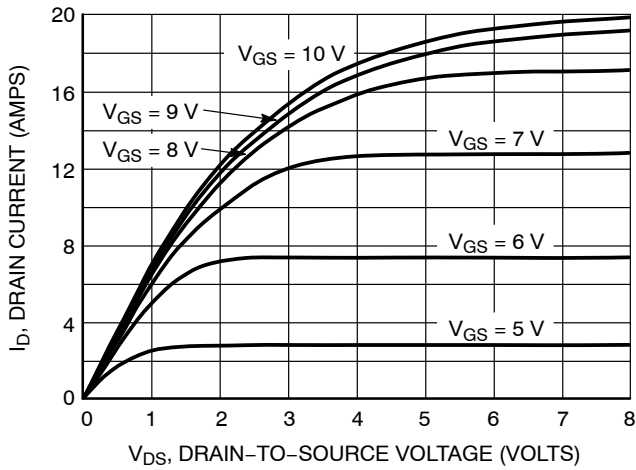

**Figure 1. On-Region Characteristics**

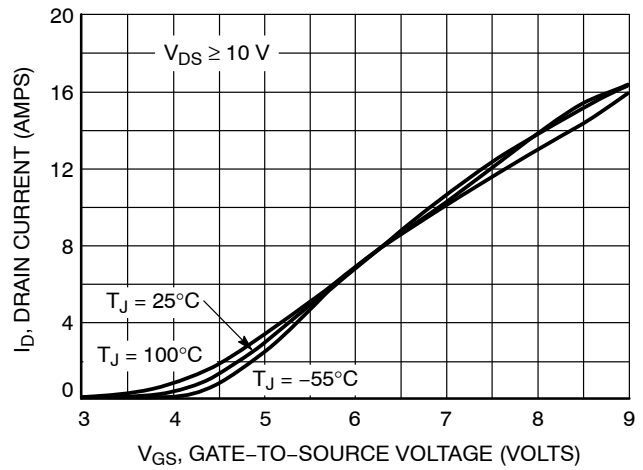

**Figure 2. Transfer Characteristics**

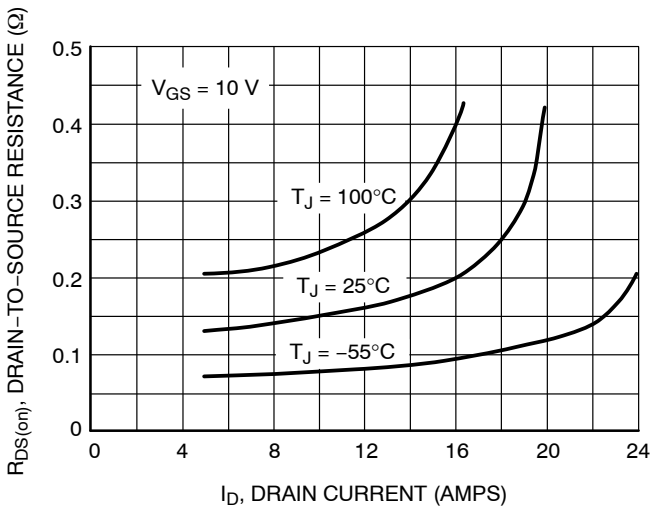

**Figure 3. On-Resistance versus Gate-to-Source Voltage**

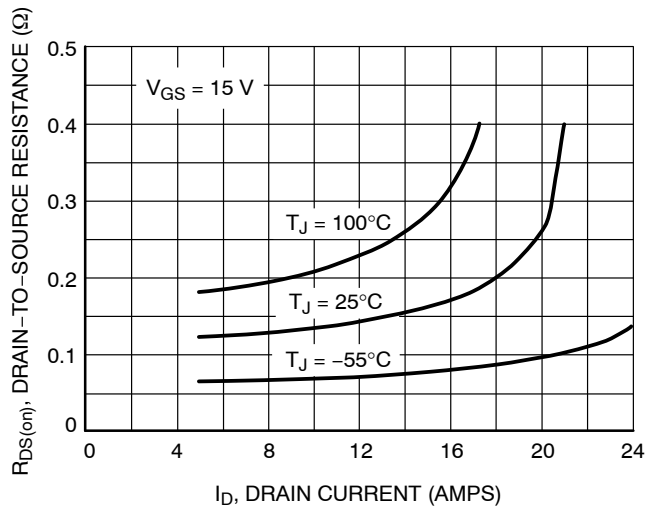

**Figure 4. On-Resistance versus Drain Current and Gate Voltage**

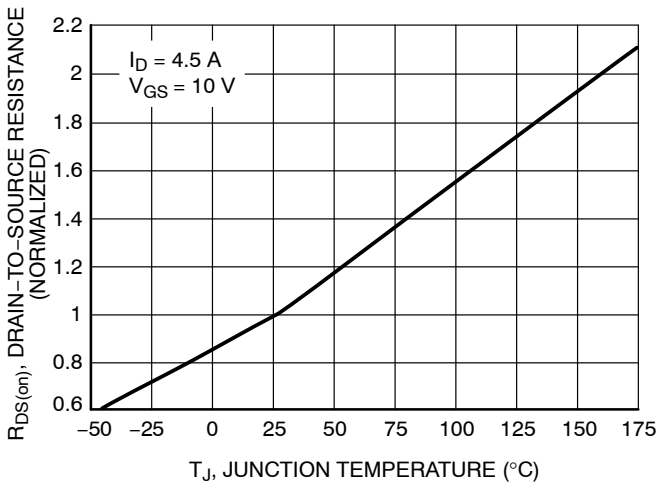

**Figure 5. On-Resistance Variation with Temperature**

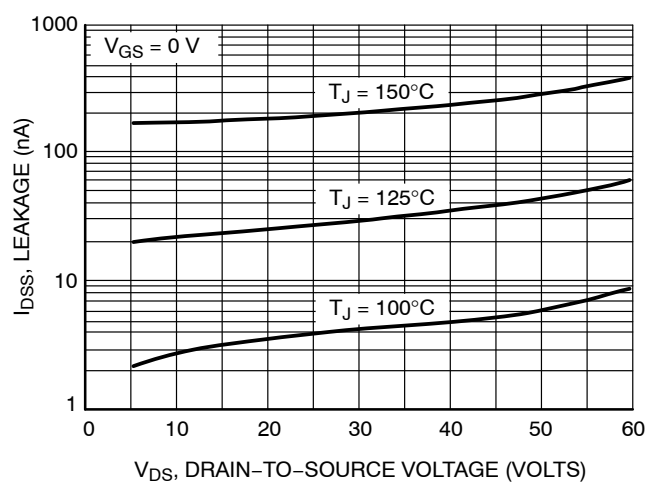

**Figure 6. Drain-to-Source Leakage Current versus Voltage**

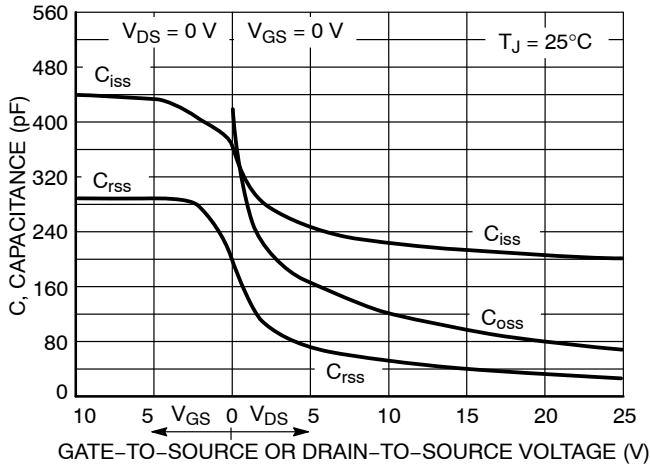

Figure 7. Capacitance Variation

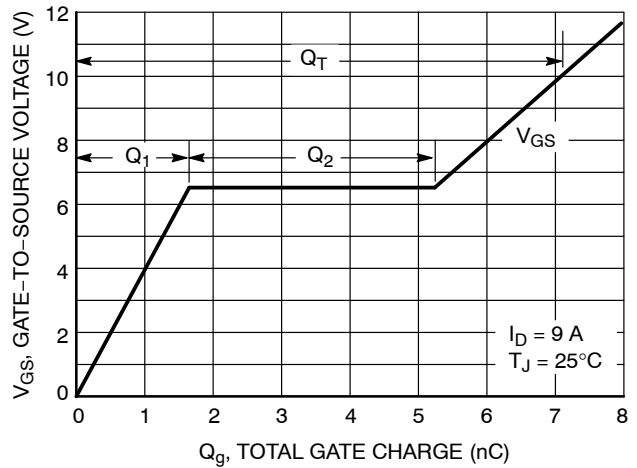

Figure 8. Gate-to-Source and Drain-to-Source Voltage versus Total Charge

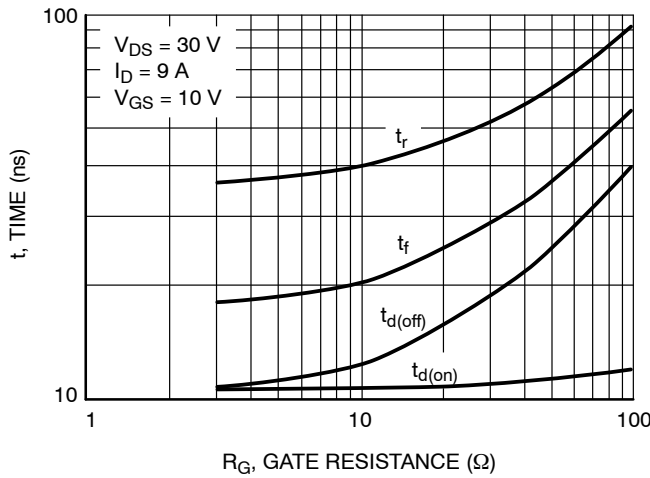

Figure 9. Resistive Switching Time Variation versus Gate Resistance

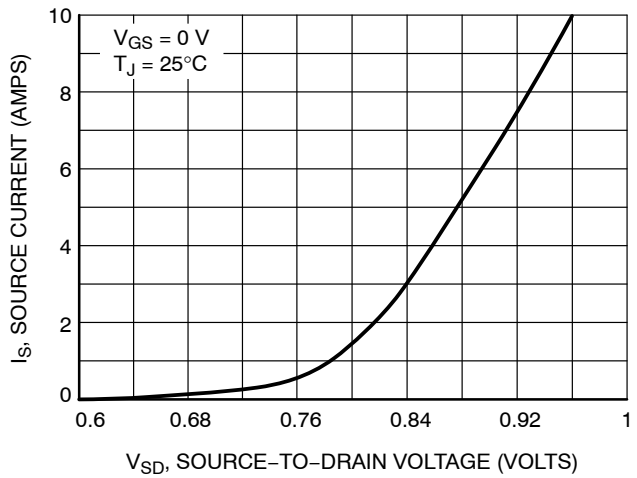

Figure 10. Diode Forward Voltage versus Current

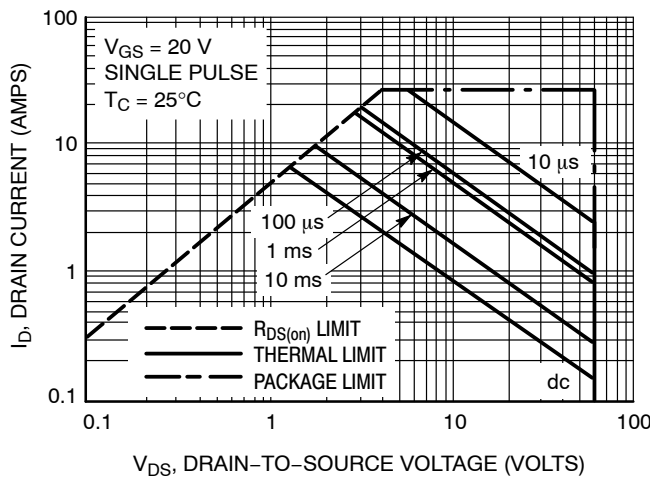

Figure 11. Maximum Rated Forward Biased Safe Operating Area

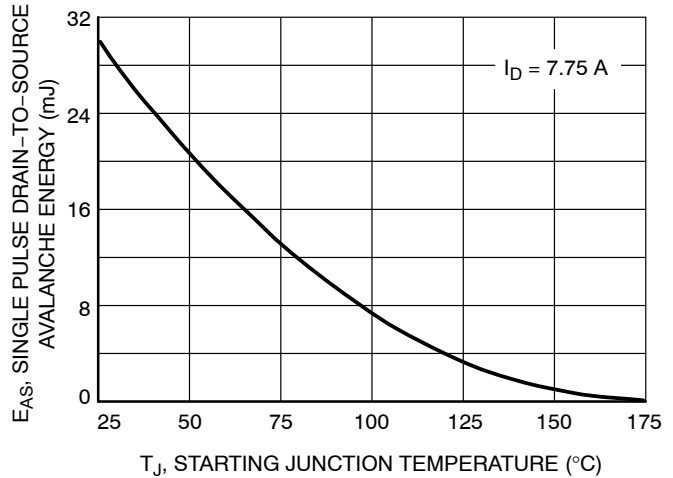
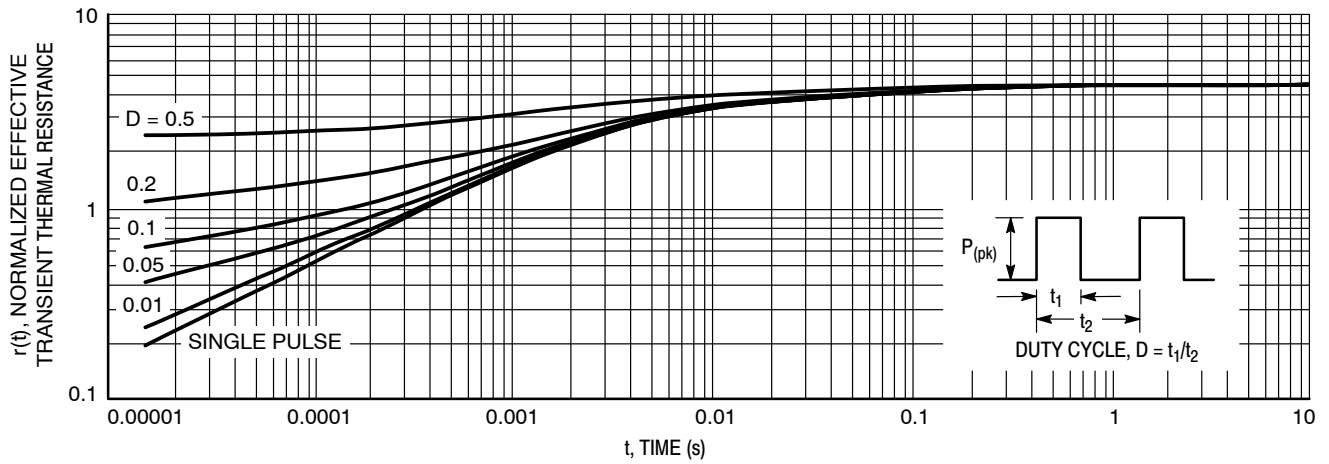

Figure 12. Maximum Avalanche Energy versus Starting Junction Temperature

## NTD3055-150, NVD3055-150



**Figure 13. Thermal Response**

### ORDERING INFORMATION

Device	Package	Shipping <sup>†</sup>
NTD3055-150G	DPAK (Pb-Free)	75 Units / Rail
NTD3055-150-1G	IPAK (Pb-Free)	75 Units / Rail
NTD3055-150T4G	DPAK (Pb-Free)	2500 / Tape & Reel
NTD3055-150T4H	DPAK (Halide-Free)	2500 / Tape & Reel
NVD3055-150T4G*	DPAK (Pb-Free)	2500 / Tape & Reel
NVD3055-150T4G-VF01	DPAK (Pb-Free)	2500 / Tape & Reel

<sup>†</sup>For information on tape and reel specifications, including part orientation and tape sizes, please refer to our Tape and Reel Packaging Specifications Brochure, BRD8011/D.

\*NVD Prefix for Automotive and Other Applications Requiring Unique Site and Control Change Requirements; AEC-Q101 Qualified and PPAP Capable.

# MECHANICAL CASE OUTLINE

## PACKAGE DIMENSIONS

ON Semiconductor®



### IPAK CASE 369D-01 ISSUE C

DATE 15 DEC 2010

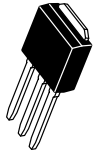

SCALE 1:1

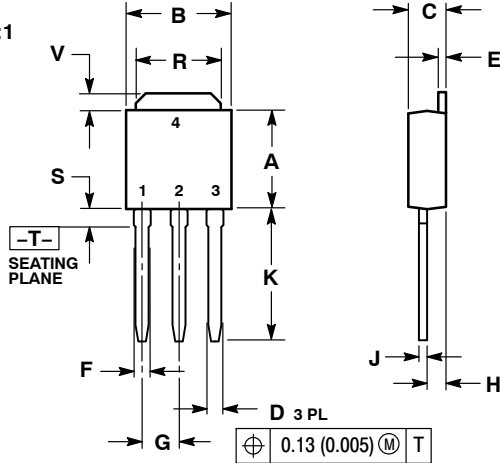

NOTES:

1. DIMENSIONING AND TOLERANCING PER ANSI Y14.5M, 1982.
2. CONTROLLING DIMENSION: INCH.

DIM	INCHES		MILLIMETERS	
	MIN	MAX	MIN	MAX
A	0.235	0.245	5.97	6.35
B	0.250	0.265	6.35	6.73
C	0.086	0.094	2.19	2.38
D	0.027	0.035	0.69	0.88
E	0.018	0.023	0.46	0.58
F	0.037	0.045	0.94	1.14
G	0.090	BSC	2.29	BSC
H	0.034	0.040	0.87	1.01
J	0.018	0.023	0.46	0.58
K	0.350	0.380	8.89	9.65
R	0.180	0.215	4.45	5.45
S	0.025	0.040	0.63	1.01
V	0.035	0.050	0.89	1.27
Z	0.155	---	3.93	---

### MARKING DIAGRAMS

- |  |   |  |  |
|--|---|--|--|
| <p>STYLE 1:<br/>PIN 1. BASE<br/>2. COLLECTOR<br/>3. EMITTER<br/>4. COLLECTOR</p> | <p>STYLE 2:<br/>PIN 1. GATE<br/>2. DRAIN<br/>3. SOURCE<br/>4. DRAIN</p> | <p>STYLE 3:<br/>PIN 1. ANODE<br/>2. CATHODE<br/>3. ANODE<br/>4. CATHODE</p>      | <p>STYLE 4:<br/>PIN 1. CATHODE<br/>2. ANODE<br/>3. GATE<br/>4. ANODE</p> |
| <p>STYLE 5:<br/>PIN 1. GATE<br/>2. ANODE<br/>3. CATHODE<br/>4. ANODE</p>         | <p>STYLE 6:<br/>PIN 1. MT1<br/>2. MT2<br/>3. GATE<br/>4. MT2</p>        | <p>STYLE 7:<br/>PIN 1. GATE<br/>2. COLLECTOR<br/>3. EMITTER<br/>4. COLLECTOR</p> |  |

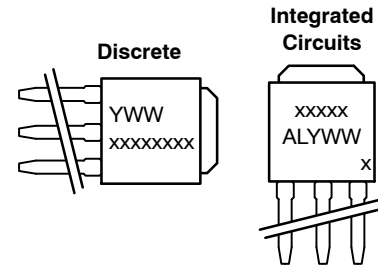

xxxxxxxx = Device Code  
 A = Assembly Location  
 IL = Wafer Lot  
 Y = Year  
 WW = Work Week

DOCUMENT NUMBER:	98AON10528D	Electronic versions are uncontrolled except when accessed directly from the Document Repository. Printed versions are uncontrolled except when stamped "CONTROLLED COPY" in red.
DESCRIPTION:	IPAK (DPAK INSERTION MOUNT)	PAGE 1 OF 1

ON Semiconductor and are trademarks of Semiconductor Components Industries, LLC dba ON Semiconductor or its subsidiaries in the United States and/or other countries. ON Semiconductor reserves the right to make changes without further notice to any products herein. ON Semiconductor makes no warranty, representation or guarantee regarding the suitability of its products for any particular purpose, nor does ON Semiconductor assume any liability arising out of the application or use of any product or circuit, and specifically disclaims any and all liability, including without limitation special, consequential or incidental damages. ON Semiconductor does not convey any license under its patent rights nor the rights of others.



**onsemi**, **Onsemi**, and other names, marks, and brands are registered and/or common law trademarks of Semiconductor Components Industries, LLC dba "**onsemi**" or its affiliates and/or subsidiaries in the United States and/or other countries. **onsemi** owns the rights to a number of patents, trademarks, copyrights, trade secrets, and other intellectual property. A listing of **onsemi**'s product/patent coverage may be accessed at [www.onsemi.com/site/pdf/Patent-Marking.pdf](http://www.onsemi.com/site/pdf/Patent-Marking.pdf). **onsemi** reserves the right to make changes at any time to any products or information herein, without notice. The information herein is provided "as-is" and **onsemi** makes no warranty, representation or guarantee regarding the accuracy of the information, product features, availability, functionality, or suitability of its products for any particular purpose, nor does **onsemi** assume any liability arising out of the application or use of any product or circuit, and specifically disclaims any and all liability, including without limitation special, consequential or incidental damages. Buyer is responsible for its products and applications using **onsemi** products, including compliance with all laws, regulations and safety requirements or standards, regardless of any support or applications information provided by **onsemi**. "Typical" parameters which may be provided in **onsemi** data sheets and/or specifications can and do vary in different applications and actual performance may vary over time. All operating parameters, including "Typicals" must be validated for each customer application by customer's technical experts. **onsemi** does not convey any license under any of its intellectual property rights nor the rights of others. **onsemi** products are not designed, intended, or authorized for use as a critical component in life support systems or any FDA Class 3 medical devices or medical devices with a same or similar classification in a foreign jurisdiction or any devices intended for implantation in the human body. Should Buyer purchase or use **onsemi** products for any such unintended or unauthorized application, Buyer shall indemnify and hold **onsemi** and its officers, employees, subsidiaries, affiliates, and distributors harmless against all claims, costs, damages, and expenses, and reasonable attorney fees arising out of, directly or indirectly, any claim of personal injury or death associated with such unintended or unauthorized use, even if such claim alleges that **onsemi** was negligent regarding the design or manufacture of the part. **onsemi** is an Equal Opportunity/Affirmative Action Employer. This literature is subject to all applicable copyright laws and is not for resale in any manner.

---

## ADDITIONAL INFORMATION

### TECHNICAL PUBLICATIONS:

Technical Library: [www.onsemi.com/design/resources/technical-documentation](http://www.onsemi.com/design/resources/technical-documentation)  
onsemi Website: [www.onsemi.com](http://www.onsemi.com)

### ONLINE SUPPORT: [www.onsemi.com/support](http://www.onsemi.com/support)

For additional information, please contact your local Sales Representative at [www.onsemi.com/support/sales](http://www.onsemi.com/support/sales)

## Looking for pricing, stock, or lifecycle information?

Click below to explore more details on WIN SOURCE:

- ⊖ [View NTD3055-150T4G on WIN SOURCE](#)
- ⊖ [ON Semiconductor Information](#)

## Optimize Your Supply Chain with WIN SOURCE Solutions

- ✓ Global Sourcing Solution
- ✓ Obsolete Management
- ✓ Cost Control Management
- ✓ Shortage Management
- ✓ Alternative Solution
- ✓ Excess Inventory Management