



**THE DATASHEET OF
NTD3055L170T4G**



NTD3055L170, NVD3055L170

MOSFET – Power, N-Channel, Logic Level, DPAK/IPAK 9.0 A, 60 V

Designed for low voltage, high speed switching applications in power supplies, converters and power motor controls and bridge circuits.

Features

- NVD Prefix for Automotive and Other Applications Requiring Unique Site and Control Change Requirements; AEC-Q101 Qualified and PPAP Capable
- These are Pb-Free Devices

Typical Applications

- Power Supplies
- Converters
- Power Motor Controls
- Bridge Circuits

MAXIMUM RATINGS (T_J = 25°C unless otherwise noted)

| Rating | Symbol | Value | Unit |
|---|-----------------------------------|------------|------|
| Drain-to-Source Voltage | V _{DSS} | 60 | Vdc |
| Drain-to-Gate Voltage (R _{GS} = 10 MΩ) | V _{DGR} | 60 | Vdc |
| Gate-to-Source Voltage | V _{GS} | | Vdc |
| – Continuous | V _{GS} | ±15 | |
| – Non-repetitive (t _p ≤ 10 ms) | V _{GS} | ±20 | |
| Drain Current | I _D | | Adc |
| – Continuous @ T _A = 25°C | I _D | 9.0 | |
| – Continuous @ T _A = 100°C | I _D | 3.0 | |
| – Single Pulse (t _p ≤ 10 μs) | I _{DM} | 27 | Apk |
| Total Power Dissipation @ T _A = 25°C | P _D | 28.5 | W |
| Derate above 25°C | | 0.19 | W/°C |
| Total Power Dissipation @ T _A = 25°C (Note 1) | | 2.1 | W |
| Total Power Dissipation @ T _A = 25°C (Note 2) | | 1.5 | W |
| Operating and Storage Temperature Range | T _J , T _{stg} | –55 to 175 | °C |
| Single Pulse Drain-to-Source Avalanche Energy – Starting T _J = 25°C (V _{DD} = 25 Vdc, V _{GS} = 5.0 Vdc, L = 1.0 mH, I _{L(pk)} = 7.75 A, V _{DS} = 60 Vdc) | E _{AS} | 30 | mJ |
| Thermal Resistance | | | °C/W |
| – Junction-to-Case | R _{θJC} | 5.2 | |
| – Junction-to-Ambient (Note 1) | R _{θJA} | 71.4 | |
| – Junction-to-Ambient (Note 2) | R _{θJA} | 100 | |
| Maximum Lead Temperature for Soldering Purposes, 1/8" from case for 10 seconds | T _L | 260 | °C |

Stresses exceeding those listed in the Maximum Ratings table may damage the device. If any of these limits are exceeded, device functionality should not be assumed, damage may occur and reliability may be affected.



ON Semiconductor®

www.onsemi.com

9.0 AMPERES, 60 VOLTS

R_{DS(on)} = 170 mΩ

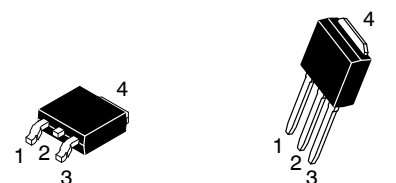
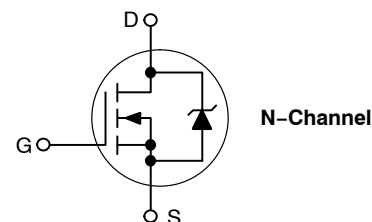

DPAK
CASE 369C
(Surface Mounted)
STYLE 2

IPAK
CASE 369D
(Straight Lead)
STYLE 2

MARKING DIAGRAMS & PIN ASSIGNMENTS

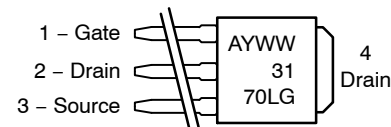
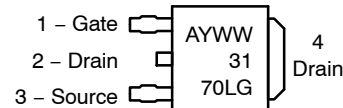

A = Assembly Location*
Y = Year
WW = Work Week
3170L = Device Code
G = Pb-Free Package

* The Assembly Location code (A) is front side optional. In cases where the Assembly Location is stamped in the package, the front side assembly code may be blank.

ORDERING INFORMATION

See detailed ordering and shipping information in the package dimensions section on page 8 of this data sheet.

NTD3055L170, NVD3055L170

1. When surface mounted to an FR4 board using 0.5 sq in pad size.
2. When surface mounted to an FR4 board using minimum recommended pad size.

NTD3055L170, NVD3055L170

ELECTRICAL CHARACTERISTICS (T_J = 25°C unless otherwise noted)

| Characteristic | Symbol | Min | Typ | Max | Unit |
|---|----------------------|---------|-----------|-----------|--------------|
| OFF CHARACTERISTICS | | | | | |
| Drain-to-Source Breakdown Voltage (Note 3) (V _{GS} = 0 Vdc, I _D = 250 μAdc) Temperature Coefficient (Positive) | V _{(BR)DSS} | 60 – | – 53.6 | – – | Vdc mV/°C |
| Zero Gate Voltage Drain Current (V _{DS} = 60 Vdc, V _{GS} = 0 Vdc) (V _{DS} = 60 Vdc, V _{GS} = 0 Vdc, T _J = 150°C) | I _{DSS} | – – | – – | 1.0 10 | μAdc |
| Gate-Body Leakage Current (V _{GS} = ±15 Vdc, V _{DS} = 0 Vdc) | I _{GSS} | – | – | ±100 | nAdc |

ON CHARACTERISTICS (Note 3)

| | | | | | |
|--|---------------------|----------|------------|----------|--------------|
| Gate Threshold Voltage (Note 3) (V _{DS} = V _{GS} , I _D = 250 μAdc) Threshold Temperature Coefficient (Negative) | V _{GS(th)} | 1.0 – | 1.7 4.2 | 2.0 – | Vdc mV/°C |
| Static Drain-to-Source On-Resistance (Note 3) (V _{GS} = 5.0 Vdc, I _D = 4.5 Adc) | R _{DS(on)} | – | 153 | 170 | mΩ |
| Static Drain-to-Source On-Voltage (Note 3) (V _{GS} = 5.0 Vdc, I _D = 9.0 Adc) (V _{GS} = 5.0 Vdc, I _D = 4.5 Adc, T _J = 150°C) | V _{DS(on)} | – – | 1.8 1.3 | 2.1 – | Vdc |
| Forward Transconductance (Note 3) (V _{DS} = 8.0 Vdc, I _D = 6.0 Adc) | g _{FS} | – | 7.3 | – | mhos |

DYNAMIC CHARACTERISTICS

| | | | | | | |
|----------------------|---|------------------|---|-----|-----|----|
| Input Capacitance | (V _{DS} = 25 Vdc, V _{GS} = 0 Vdc, f = 1.0 MHz) | C _{iss} | – | 195 | 275 | pF |
| Output Capacitance | | C _{oss} | – | 70 | 100 | |
| Transfer Capacitance | | C _{rss} | – | 29 | 42 | |

SWITCHING CHARACTERISTICS (Note 4)

| | | | | | | |
|---------------------|--|---------------------|---|-----|-----|----|
| Turn-On Delay Time | (V _{DD} = 30 Vdc, I _D = 9.0 Adc, V _{GS} = 5.0 Vdc, R _G = 9.1 Ω) (Note 3) | t _{d(on)} | – | 9.7 | 20 | ns |
| Rise Time | | t _r | – | 69 | 150 | |
| Turn-Off Delay Time | | t _{d(off)} | – | 10 | 20 | |
| Fall Time | | t _f | – | 38 | 80 | |
| Gate Charge | (V _{DS} = 48 Vdc, I _D = 9.0 Adc, V _{GS} = 5.0 Vdc) (Note 3) | Q _T | – | 4.7 | 10 | nC |
| | | Q ₁ | – | 1.4 | – | |
| | | Q ₂ | – | 2.9 | – | |

SOURCE-DRAIN DIODE CHARACTERISTICS

| | | | | | | |
|--------------------------------|---|-----------------|--------|--------------|-----------|-----|
| Forward On-Voltage | (I _S = 9.0 Adc, V _{GS} = 0 Vdc) (Note 3) (I _S = 9.0 Adc, V _{GS} = 0 Vdc, T _J = 150°C) | V _{SD} | – – | 0.98 0.85 | 1.25 – | Vdc |
| Reverse Recovery Time | (I _S = 9.0 Adc, V _{GS} = 0 Vdc, di _S /dt = 100 A/μs) (Note 3) | t _{rr} | – | 29.8 | – | ns |
| | | t _a | – | 17.6 | – | |
| | | t _b | – | 12.2 | – | |
| Reverse Recovery Stored Charge | | Q _{RR} | – | 0.031 | – | μC |

Product parametric performance is indicated in the Electrical Characteristics for the listed test conditions, unless otherwise noted. Product performance may not be indicated by the Electrical Characteristics if operated under different conditions.

3. Pulse Test: Pulse Width ≤ 300 μs, Duty Cycle ≤ 2%.

4. Switching characteristics are independent of operating junction temperatures.

NTD3055L170, NVD3055L170

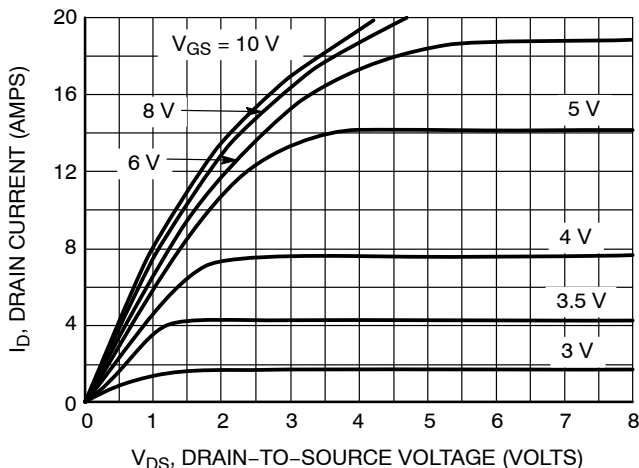

Figure 1. On-Region Characteristics

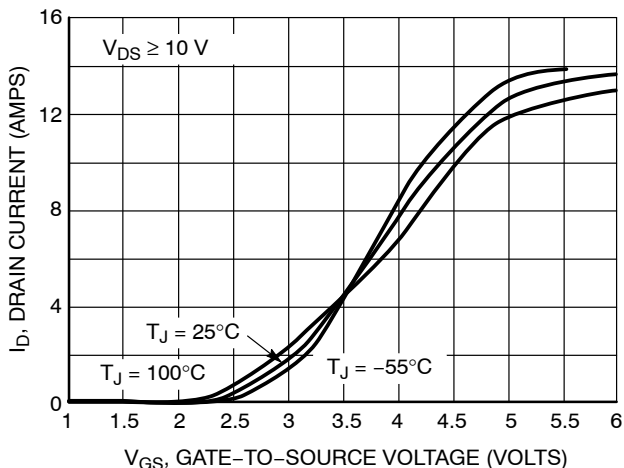

Figure 2. Transfer Characteristics

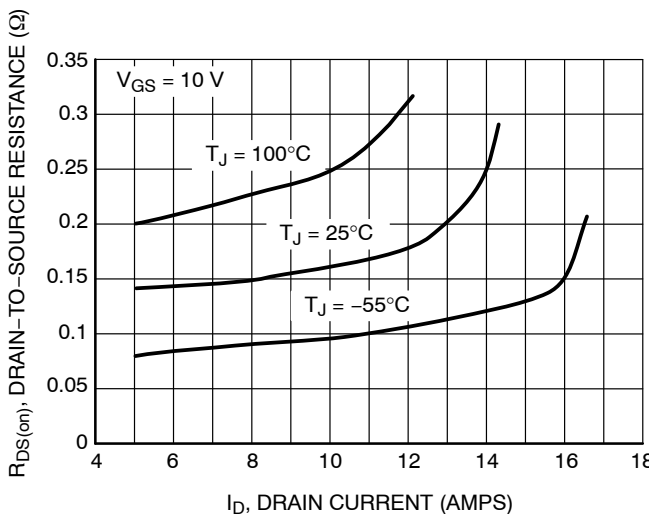

Figure 3. On-Resistance versus Gate-to-Source Voltage

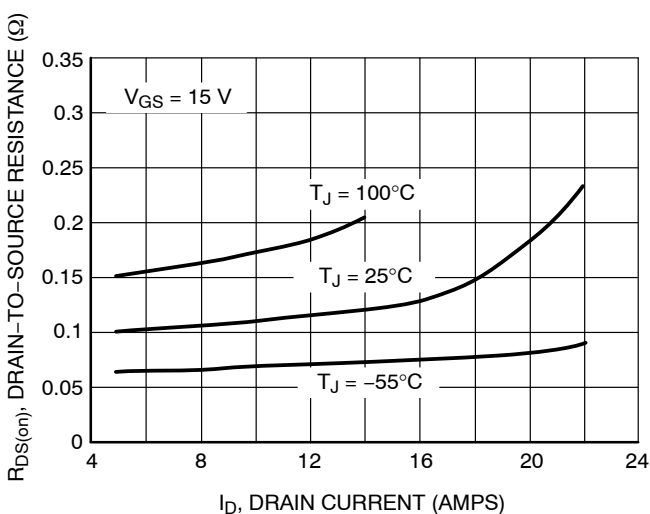

Figure 4. On-Resistance versus Drain Current and Gate Voltage

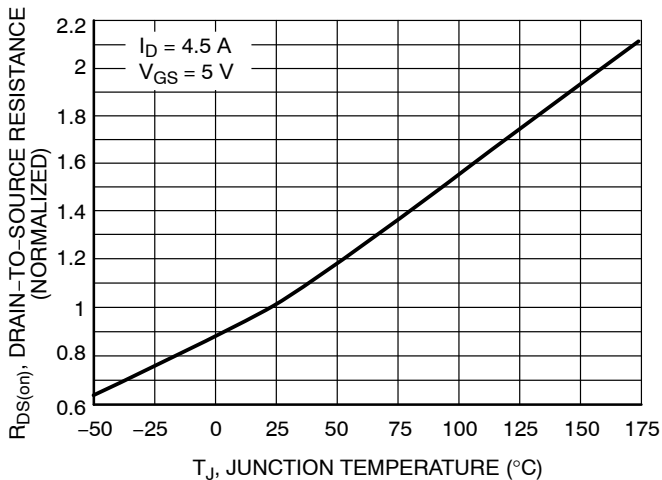

Figure 5. On-Resistance Variation with Temperature

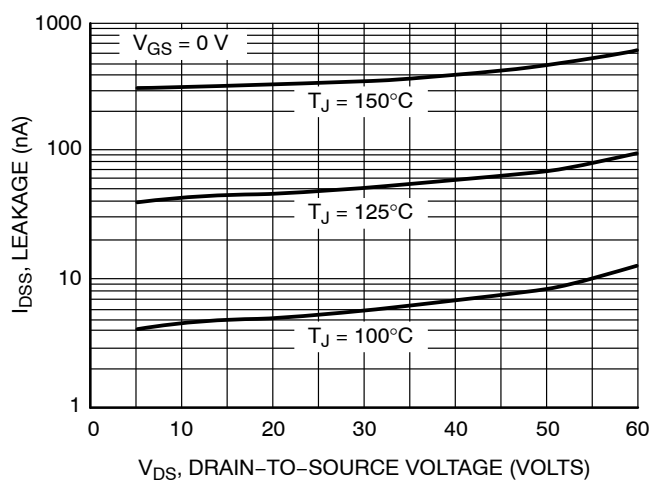

Figure 6. Drain-to-Source Leakage Current versus Voltage

POWER MOSFET SWITCHING

Switching behavior is most easily modeled and predicted by recognizing that the power MOSFET is charge controlled. The lengths of various switching intervals (Δt) are determined by how fast the FET input capacitance can be charged by current from the generator.

The published capacitance data is difficult to use for calculating rise and fall because drain-gate capacitance varies greatly with applied voltage. Accordingly, gate charge data is used. In most cases, a satisfactory estimate of average input current ($I_{G(AV)}$) can be made from a rudimentary analysis of the drive circuit so that

$$t = Q/I_{G(AV)}$$

During the rise and fall time interval when switching a resistive load, V_{GS} remains virtually constant at a level known as the plateau voltage, V_{SGP} . Therefore, rise and fall times may be approximated by the following:

$$t_r = Q_2 \times R_G / (V_{GG} - V_{SGP})$$

$$t_f = Q_2 \times R_G / V_{SGP}$$

where

V_{GG} = the gate drive voltage, which varies from zero to V_{GG}

R_G = the gate drive resistance

and Q_2 and V_{SGP} are read from the gate charge curve.

During the turn-on and turn-off delay times, gate current is not constant. The simplest calculation uses appropriate values from the capacitance curves in a standard equation for voltage change in an RC network. The equations are:

$$t_{d(on)} = R_G C_{iss} \ln [V_{GG}/(V_{GG} - V_{SGP})]$$

$$t_{d(off)} = R_G C_{iss} \ln (V_{GG}/V_{SGP})$$

The capacitance (C_{iss}) is read from the capacitance curve at a voltage corresponding to the off-state condition when calculating $t_{d(on)}$ and is read at a voltage corresponding to the on-state when calculating $t_{d(off)}$.

At high switching speeds, parasitic circuit elements complicate the analysis. The inductance of the MOSFET source lead, inside the package and in the circuit wiring which is common to both the drain and gate current paths, produces a voltage at the source which reduces the gate drive current. The voltage is determined by $L di/dt$, but since di/dt is a function of drain current, the mathematical solution is complex. The MOSFET output capacitance also complicates the mathematics. And finally, MOSFETs have finite internal gate resistance which effectively adds to the resistance of the driving source, but the internal resistance is difficult to measure and, consequently, is not specified.

The resistive switching time variation versus gate resistance (Figure 9) shows how typical switching performance is affected by the parasitic circuit elements. If the parasitics were not present, the slope of the curves would maintain a value of unity regardless of the switching speed. The circuit used to obtain the data is constructed to minimize common inductance in the drain and gate circuit loops and is believed readily achievable with board mounted components. Most power electronic loads are inductive; the data in the figure is taken with a resistive load, which approximates an optimally snubbed inductive load. Power MOSFETs may be safely operated into an inductive load; however, snubbing reduces switching losses.

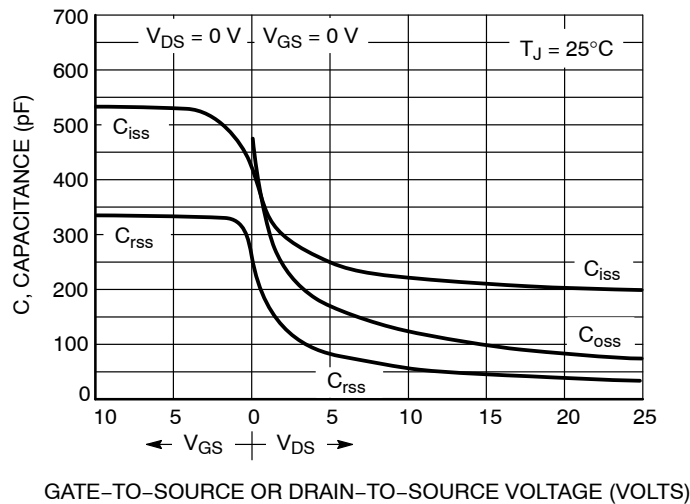

Figure 7. Capacitance Variation

NTD3055L170, NVD3055L170

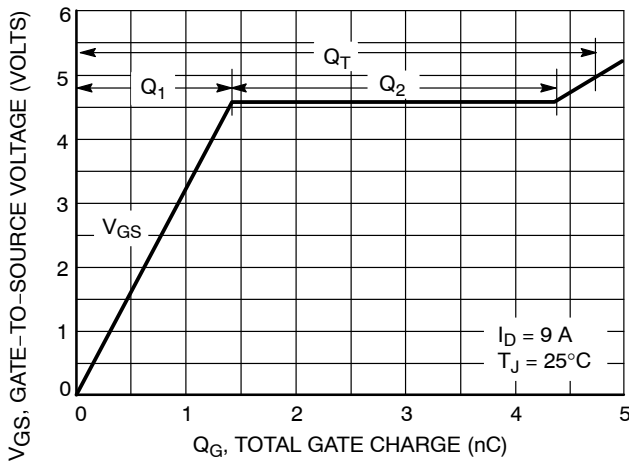

Figure 8. Gate-to-Source and Drain-to-Source Voltage versus Total Charge

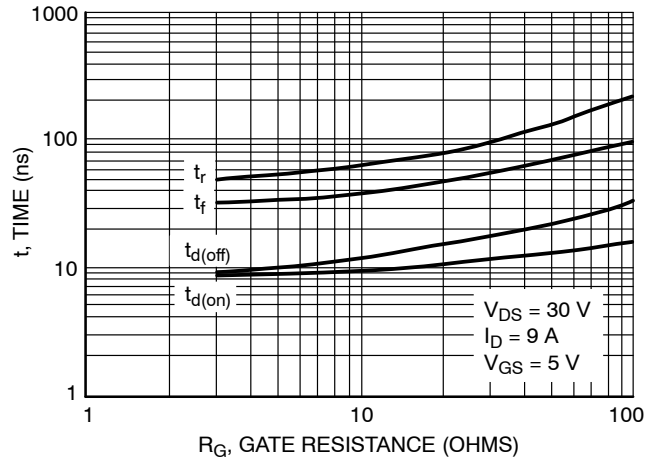

Figure 9. Resistive Switching Time Variation versus Gate Resistance

DRAIN-TO-SOURCE DIODE CHARACTERISTICS

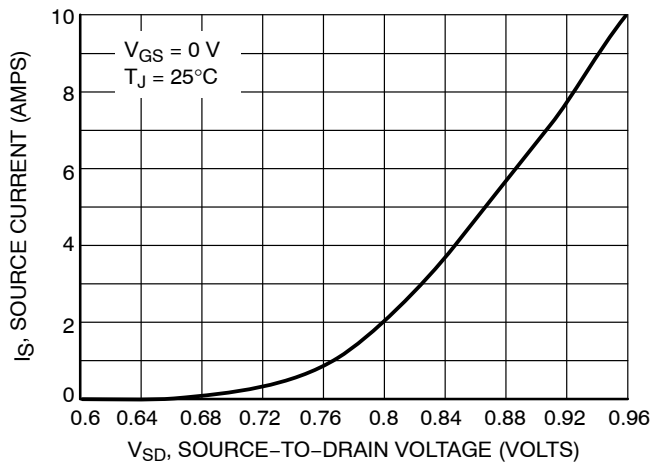

Figure 10. Diode Forward Voltage versus Current

SAFE OPERATING AREA

The Forward Biased Safe Operating Area curves define the maximum simultaneous drain-to-source voltage and drain current that a transistor can handle safely when it is forward biased. Curves are based upon maximum peak junction temperature and a case temperature (T_C) of 25°C. Peak repetitive pulsed power limits are determined by using the thermal response data in conjunction with the procedures discussed in AN569, “Transient Thermal Resistance – General Data and Its Use.”

Switching between the off-state and the on-state may traverse any load line provided neither rated peak current (I_{DM}) nor rated voltage (V_{DSS}) is exceeded and the transition time (t_r, t_f) do not exceed 10 μ s. In addition the total power averaged over a complete switching cycle must not exceed $(T_{J(MAX)} - T_C)/(R_{\theta JC})$.

A Power MOSFET designated E-FET can be safely used in switching circuits with unclamped inductive loads. For

reliable operation, the stored energy from circuit inductance dissipated in the transistor while in avalanche must be less than the rated limit and adjusted for operating conditions differing from those specified. Although industry practice is to rate in terms of energy, avalanche energy capability is not a constant. The energy rating decreases non-linearly with an increase of peak current in avalanche and peak junction temperature.

Although many E-FETs can withstand the stress of drain-to-source avalanche at currents up to rated pulsed current (I_{DM}), the energy rating is specified at rated continuous current (I_D), in accordance with industry custom. The energy rating must be derated for temperature as shown in the accompanying graph (Figure 12). Maximum energy at currents below rated continuous I_D can safely be assumed to equal the values indicated.

SAFE OPERATING AREA

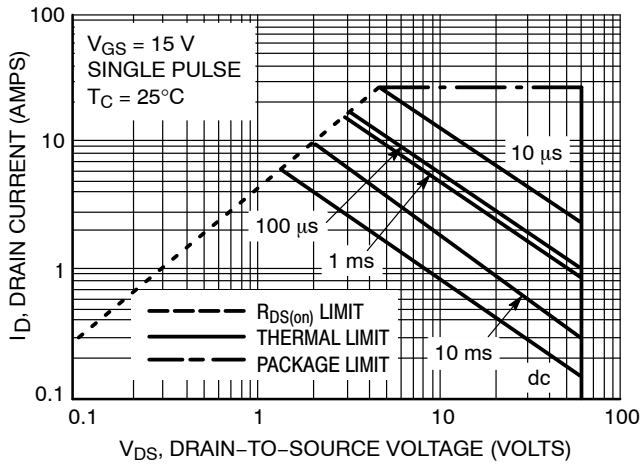

Figure 11. Maximum Rated Forward Biased Safe Operating Area

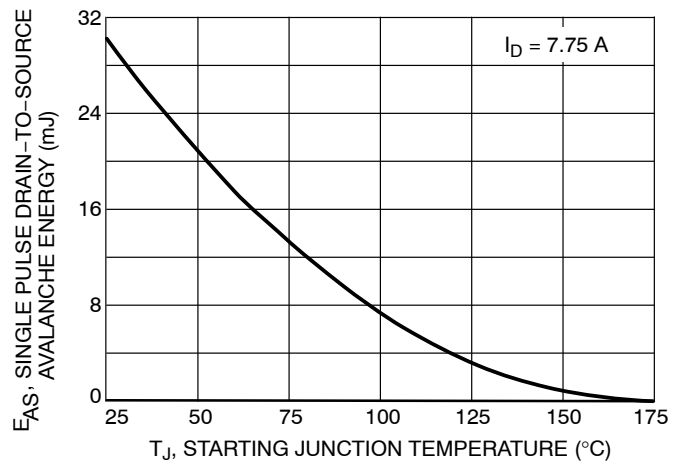

Figure 12. Maximum Avalanche Energy versus Starting Junction Temperature

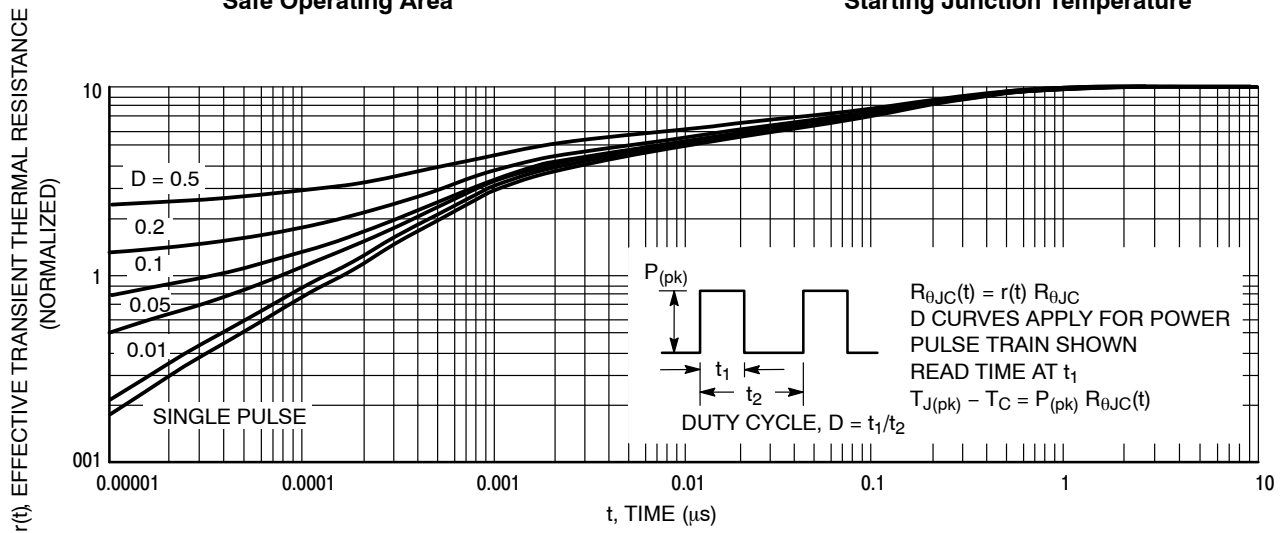

Figure 13. Thermal Response

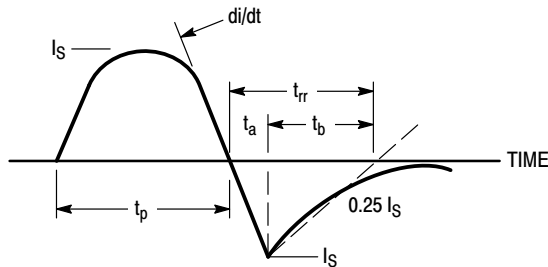

Figure 14. Diode Reverse Recovery Waveform

NTD3055L170, NVD3055L170

ORDERING INFORMATION

| Device | Package | Shipping [†] |
|----------------------|-------------------|-----------------------|
| NTD3055L170G | DPAK (Pb-Free) | 75 Units / Rail |
| NTD3055L170-1G | IPAK (Pb-Free) | 75 Units / Rail |
| NTD3055L170T4G | DPAK (Pb-Free) | 2500 / Tape & Reel |
| NVD3055L170T4G* | DPAK (Pb-Free) | 2500 / Tape & Reel |
| NVD3055L170T4G-VF01* | DPAK (Pb-Free) | 2500 / Tape & Reel |

[†]For information on tape and reel specifications, including part orientation and tape sizes, please refer to our Tape and Reel Packaging Specifications Brochure, BRD8011/D.

*NVD Prefix for Automotive and Other Applications Requiring Unique Site and Control Change Requirements; AEC-Q101 Qualified and PPAP Capable

NTD3055L170, NVD3055L170

PACKAGE DIMENSIONS

DPAK (SINGLE GAUGE) CASE 369C ISSUE F

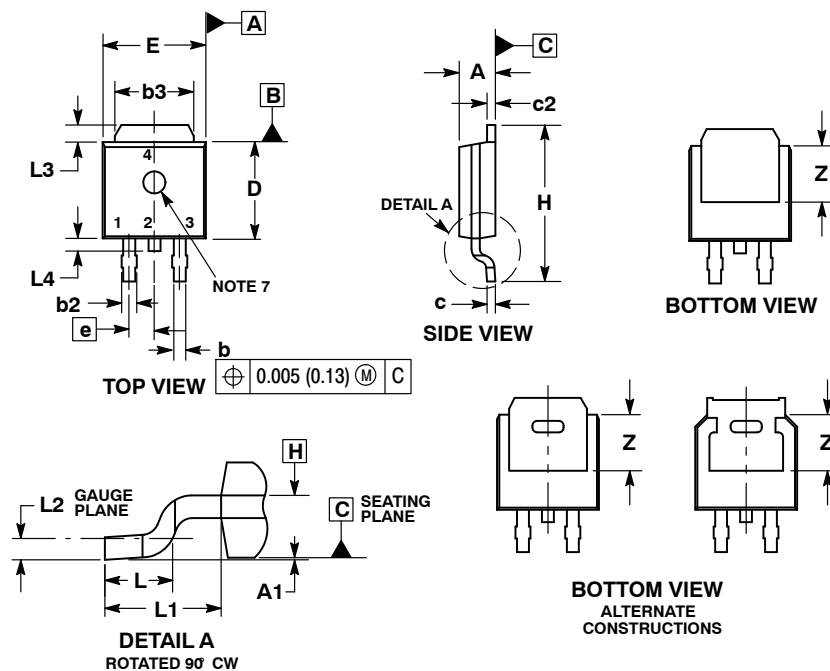

NOTES:

1. DIMENSIONING AND TOLERANCING PER ASME Y14.5M, 1994.
2. CONTROLLING DIMENSION: INCHES.
3. THERMAL PAD CONTOUR OPTIONAL WITHIN DIMENSIONS b3, L3 and Z.
4. DIMENSIONS D AND E DO NOT INCLUDE MOLD FLASH, PROTRUSIONS, OR BURRS. MOLD FLASH, PROTRUSIONS, OR GATE BURRS SHALL NOT EXCEED 0.006 INCHES PER SIDE.
5. DIMENSIONS D AND E ARE DETERMINED AT THE OUTERMOST EXTREMES OF THE PLASTIC BODY.
6. DATUMS A AND B ARE DETERMINED AT DATUM PLANE H.
7. OPTIONAL MOLD FEATURE.

| DIM | INCHES | | MILLIMETERS | |
|-----|--------|-------|-------------|-------|
| | MIN | MAX | MIN | MAX |
| A | 0.086 | 0.094 | 2.18 | 2.38 |
| A1 | 0.000 | 0.005 | 0.00 | 0.13 |
| b | 0.025 | 0.035 | 0.63 | 0.89 |
| b2 | 0.028 | 0.045 | 0.72 | 1.14 |
| b3 | 0.180 | 0.215 | 4.57 | 5.46 |
| c | 0.018 | 0.024 | 0.46 | 0.61 |
| c2 | 0.018 | 0.024 | 0.46 | 0.61 |
| D | 0.235 | 0.245 | 5.97 | 6.22 |
| E | 0.250 | 0.265 | 6.35 | 6.73 |
| e | 0.090 | BSC | 2.29 | BSC |
| H | 0.370 | 0.410 | 9.40 | 10.41 |
| L | 0.055 | 0.070 | 1.40 | 1.78 |
| L1 | 0.114 | REF | 2.90 | REF |
| L2 | 0.020 | BSC | 0.51 | BSC |
| L3 | 0.035 | 0.050 | 0.89 | 1.27 |
| L4 | --- | 0.040 | --- | 1.01 |
| Z | 0.155 | --- | 3.93 | --- |

STYLE 2:

- PIN 1. GATE
2. DRAIN
3. SOURCE
4. DRAIN

SOLDERING FOOTPRINT*

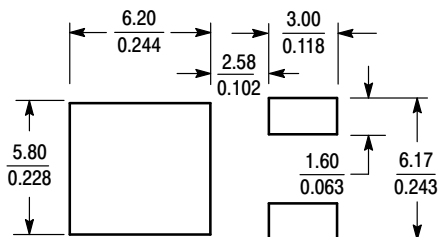

SCALE 3:1 $\left(\frac{\text{mm}}{\text{inches}}\right)$

*For additional information on our Pb-Free strategy and soldering details, please download the ON Semiconductor Soldering and Mounting Techniques Reference Manual, SOLDERRM/D.

NTD3055L170, NVD3055L170

PACKAGE DIMENSIONS

IPAK CASE 369D ISSUE C

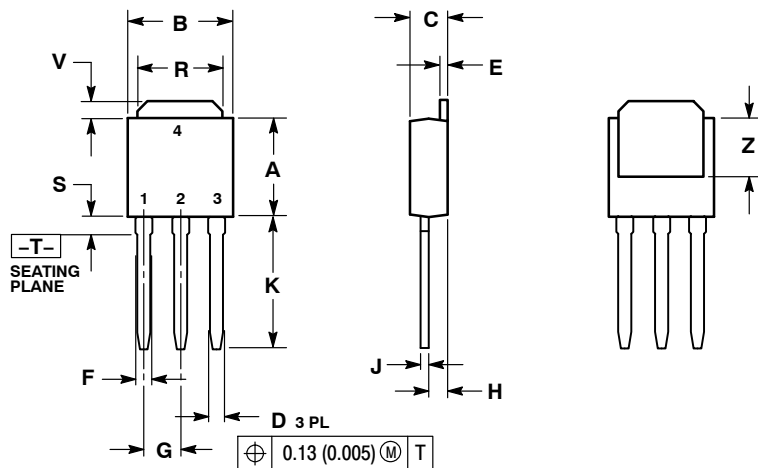

- NOTES:
1. DIMENSIONING AND TOLERANCING PER ANSI Y14.5M, 1982.
2. CONTROLLING DIMENSION: INCH.

| DIM | INCHES | | MILLIMETERS | |
|-----|-----------|-------|-------------|------|
| | MIN | MAX | MIN | MAX |
| A | 0.235 | 0.245 | 5.97 | 6.35 |
| B | 0.250 | 0.265 | 6.35 | 6.73 |
| C | 0.086 | 0.094 | 2.19 | 2.38 |
| D | 0.027 | 0.035 | 0.69 | 0.88 |
| E | 0.018 | 0.023 | 0.46 | 0.58 |
| F | 0.037 | 0.045 | 0.94 | 1.14 |
| G | 0.090 BSC | | 2.29 BSC | |
| H | 0.034 | 0.040 | 0.87 | 1.01 |
| J | 0.018 | 0.023 | 0.46 | 0.58 |
| K | 0.350 | 0.380 | 8.89 | 9.65 |
| R | 0.180 | 0.215 | 4.45 | 5.45 |
| S | 0.025 | 0.040 | 0.63 | 1.01 |
| V | 0.035 | 0.050 | 0.89 | 1.27 |
| Z | 0.155 | --- | 3.93 | --- |

- STYLE 2:
PIN 1. GATE
2. DRAIN
3. SOURCE
4. DRAIN

ON Semiconductor and are trademarks of Semiconductor Components Industries, LLC dba ON Semiconductor or its subsidiaries in the United States and/or other countries. ON Semiconductor owns the rights to a number of patents, trademarks, copyrights, trade secrets, and other intellectual property. A listing of ON Semiconductor's product/patent coverage may be accessed at www.onsemi.com/site/pdf/Patent-Marking.pdf. ON Semiconductor reserves the right to make changes without further notice to any products herein. ON Semiconductor makes no warranty, representation or guarantee regarding the suitability of its products for any particular purpose, nor does ON Semiconductor assume any liability arising out of the application or use of any product or circuit, and specifically disclaims any and all liability, including without limitation special, consequential or incidental damages. Buyer is responsible for its products and applications using ON Semiconductor products, including compliance with all laws, regulations and safety requirements or standards, regardless of any support or applications information provided by ON Semiconductor. "Typical" parameters which may be provided in ON Semiconductor data sheets and/or specifications can and do vary in different applications and actual performance may vary over time. All operating parameters, including "Typicals" must be validated for each customer application by customer's technical experts. ON Semiconductor does not convey any license under its patent rights nor the rights of others. ON Semiconductor products are not designed, intended, or authorized for use as a critical component in life support systems or any FDA Class 3 medical devices or medical devices with a same or similar classification in a foreign jurisdiction or any devices intended for implantation in the human body. Should Buyer purchase or use ON Semiconductor products for any such unintended or unauthorized application, Buyer shall indemnify and hold ON Semiconductor and its officers, employees, subsidiaries, affiliates, and distributors harmless against all claims, costs, damages, and expenses, and reasonable attorney fees arising out of, directly or indirectly, any claim of personal injury or death associated with such unintended or unauthorized use, even if such claim alleges that ON Semiconductor was negligent regarding the design or manufacture of the part. ON Semiconductor is an Equal Opportunity/Affirmative Action Employer. This literature is subject to all applicable copyright laws and is not for resale in any manner.

PUBLICATION ORDERING INFORMATION

LITERATURE FULFILLMENT:
Literature Distribution Center for ON Semiconductor
19521 E. 32nd Pkwy, Aurora, Colorado 80011 USA
Phone: 303-675-2175 or 800-344-3860 Toll Free USA/Canada
Fax: 303-675-2176 or 800-344-3867 Toll Free USA/Canada
Email: orderlit@onsemi.com

N. American Technical Support: 800-282-9855 Toll Free
USA/Canada
Europe, Middle East and Africa Technical Support:
Phone: 421 33 790 2910
Japan Customer Focus Center
Phone: 81-3-5817-1050

ON Semiconductor Website: www.onsemi.com
Order Literature: <http://www.onsemi.com/orderlit>

For additional information, please contact your local Sales Representative

Looking for pricing, stock, or lifecycle information?

Click below to explore more details on WIN SOURCE:

 [View NTD3055L170T4G on WIN SOURCE](#)

 [ON Semiconductor](#) Information

Optimize Your Supply Chain with WIN SOURCE Solutions

-  Global Sourcing Solution
-  Obsolete Management
-  Cost Control Management
-  Shortage Management
-  Alternative Solution
-  Excess Inventory Management