



**THE DATASHEET OF
NTD4858NT4G**



NTD4858N

MOSFET – Power, Single, N-Channel, DPAK/IPAK 25 V, 73 A



ON Semiconductor®

<http://onsemi.com>

Features

- Trench Technology
- Low $R_{DS(on)}$ to Minimize Conduction Losses
- Low Capacitance to Minimize Driver Losses
- Optimized Gate Charge to Minimize Switching Losses
- These are Pb-Free Devices

Applications

- VCore Applications
- DC-DC Converters
- High/Low Side Switching

MAXIMUM RATINGS ($T_J = 25^\circ\text{C}$ unless otherwise stated)

| Parameter | Symbol | Value | Unit | | |
|--|--------------------------|--------------------------|------------------|------------------|---|
| Drain-to-Source Voltage | V_{DSS} | 25 | V | | |
| Gate-to-Source Voltage | V_{GS} | ± 20 | V | | |
| Continuous Drain Current $R_{\theta JA}$ (Note 1) | I_D | $T_A = 25^\circ\text{C}$ | 14 | | |
| | | $T_A = 85^\circ\text{C}$ | 10.9 | | |
| Power Dissipation $R_{\theta JA}$ (Note 1) | P_D | $T_A = 25^\circ\text{C}$ | 2.0 | | |
| | | $T_A = 85^\circ\text{C}$ | | | |
| Continuous Drain Current $R_{\theta JA}$ (Note 2) | I_D | $T_A = 25^\circ\text{C}$ | 11.2 | | |
| | | $T_A = 85^\circ\text{C}$ | 8.7 | | |
| Power Dissipation $R_{\theta JA}$ (Note 2) | P_D | $T_A = 25^\circ\text{C}$ | 1.3 | | |
| | | | | | |
| Continuous Drain Current $R_{\theta JC}$ (Note 1) | I_D | $T_C = 25^\circ\text{C}$ | 73 | | |
| | | $T_C = 85^\circ\text{C}$ | 56 | | |
| Power Dissipation $R_{\theta JC}$ (Note 1) | P_D | $T_C = 25^\circ\text{C}$ | 54.5 | | |
| | | | | | |
| Pulsed Drain Current | $t_p = 10\mu\text{s}$ | $T_A = 25^\circ\text{C}$ | I_{DM} | 146 | A |
| Current Limited by Package | $T_A = 25^\circ\text{C}$ | $I_{DmaxPkg}$ | 45 | A | |
| Operating Junction and Storage Temperature | T_J, T_{STG} | | -55 to +175 | $^\circ\text{C}$ | |
| | | | | | |
| Source Current (Body Diode) | I_S | 45 | A | | |
| Drain to Source dV/dt | dV/dt | 6 | V/ns | | |
| Single Pulse Drain-to-Source Avalanche Energy ($T_J = 25^\circ\text{C}$, $V_{DD} = 50\text{ V}$, $V_{GS} = 10\text{ V}$, $I_L = 15\text{ A}_{pk}$, $L = 1.0\text{ mH}$, $R_G = 25\ \Omega$) | EAS | 112.5 | mJ | | |
| Lead Temperature for Soldering Purposes (1/8" from case for 10 s) | T_L | 260 | $^\circ\text{C}$ | | |

Stresses exceeding those listed in the Maximum Ratings table may damage the device. If any of these limits are exceeded, device functionality should not be assumed, damage may occur and reliability may be affected.

| $V_{(BR)DSS}$ | $R_{DS(ON)} \text{ MAX}$ | $I_D \text{ MAX}$ |
|---------------|--------------------------|-------------------|
| 25 V | 6.2 m Ω @ 10 V | 73 A |
| | 9.3 m Ω @ 4.5 V | |

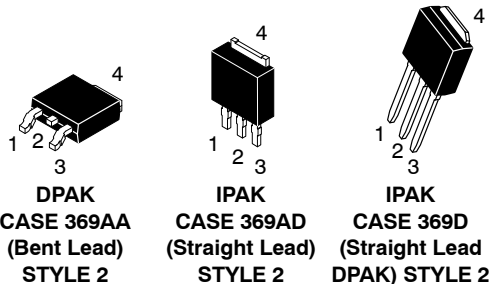
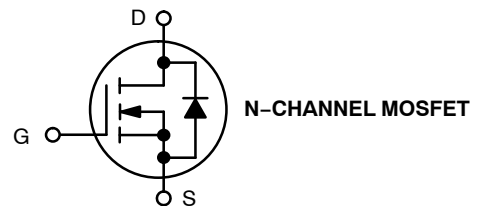

MARKING DIAGRAMS & PIN ASSIGNMENTS

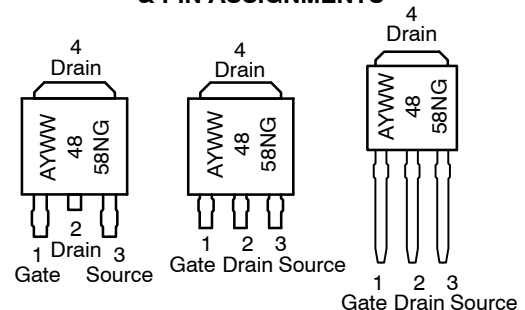

- A = Assembly Location*
- Y = Year
- WW = Work Week
- 4858N = Device Code
- G = Pb-Free Package

* The Assembly Location code (A) is front side optional. In cases where the Assembly Location is stamped in the package, the front side assembly code may be blank.

ORDERING INFORMATION

See detailed ordering and shipping information in the package dimensions section on page 6 of this data sheet.

NTD4858N

THERMAL RESISTANCE MAXIMUM RATINGS

| Parameter | Symbol | Value | Unit |
|---|---------------------|-------|------|
| Junction-to-Case (Drain) | $R_{\theta JC}$ | 2.75 | °C/W |
| Junction-to-TAB (Drain) | $R_{\theta JC-TAB}$ | 3.5 | |
| Junction-to-Ambient – Steady State (Note 1) | $R_{\theta JA}$ | 73.5 | |
| Junction-to-Ambient – Steady State (Note 2) | $R_{\theta JA}$ | 116 | |

1. Surface-mounted on FR4 board using 1 sq-in pad, 1 oz Cu.
2. Surface-mounted on FR4 board using the minimum recommended pad size.

ELECTRICAL CHARACTERISTICS ($T_J = 25^\circ\text{C}$ unless otherwise specified)

| Parameter | Symbol | Test Condition | Min | Typ | Max | Unit |
|-----------|--------|----------------|-----|-----|-----|------|
|-----------|--------|----------------|-----|-----|-----|------|

OFF CHARACTERISTICS

| | | | | | | |
|---|-------------------|---|---------------------------|----|-----------|---------------|
| Drain-to-Source Breakdown Voltage | $V_{(BR)DSS}$ | $V_{GS} = 0\text{ V}, I_D = 250\ \mu\text{A}$ | 25 | | | V |
| Drain-to-Source Breakdown Voltage Temperature Coefficient | $V_{(BR)DSS}/T_J$ | | | 22 | | mV/°C |
| Zero Gate Voltage Drain Current | I_{DSS} | $V_{GS} = 0\text{ V}, V_{DS} = 20\text{ V}$ | $T_J = 25^\circ\text{C}$ | | 1.0 | μA |
| | | | $T_J = 125^\circ\text{C}$ | | 10 | |
| Gate-to-Source Leakage Current | I_{GSS} | $V_{DS} = 0\text{ V}, V_{GS} = \pm 20\text{ V}$ | | | ± 100 | nA |

ON CHARACTERISTICS (Note 3)

| | | | | | | | |
|--|------------------|--|---------------------|-----|-----|-------|------------|
| Gate Threshold Voltage | $V_{GS(TH)}$ | $V_{GS} = V_{DS}, I_D = 250\ \mu\text{A}$ | 1.45 | | 2.5 | V | |
| Negative Threshold Temperature Coefficient | $V_{GS(TH)}/T_J$ | | | 5.3 | | mV/°C | |
| Drain-to-Source On Resistance | $R_{DS(on)}$ | $V_{GS} = 10\text{ V}$ | $I_D = 30\text{ A}$ | | 5.2 | 6.2 | m Ω |
| | | $V_{GS} = 4.5\text{ V}$ | $I_D = 30\text{ A}$ | | 7.3 | 9.3 | |
| Forward Transconductance | g_{FS} | $V_{DS} = 1.5\text{ V}, I_D = 15\text{ A}$ | | 55 | | S | |

CHARGES AND CAPACITANCES

| | | | | | | |
|------------------------------|--------------|--|--|------|------|----|
| Input Capacitance | C_{ISS} | $V_{GS} = 0\text{ V}, f = 1.0\text{ MHz}, V_{DS} = 12\text{ V}$ | | 1563 | | pF |
| Output Capacitance | C_{OSS} | | | 405 | | |
| Reverse Transfer Capacitance | C_{RSS} | | | 200 | | |
| Total Gate Charge | $Q_{G(TOT)}$ | $V_{GS} = 4.5\text{ V}, V_{DS} = 15\text{ V}, I_D = 30\text{ A}$ | | 12.8 | 19.2 | nC |
| Threshold Gate Charge | $Q_{G(TH)}$ | | | 1.3 | | |
| Gate-to-Source Charge | Q_{GS} | | | 4.7 | | |
| Gate-to-Drain Charge | Q_{GD} | | | 5.2 | | |
| Total Gate Charge | $Q_{G(TOT)}$ | $V_{GS} = 10\text{ V}, V_{DS} = 15\text{ V}, I_D = 30\text{ A}$ | | 25.7 | | nC |

SWITCHING CHARACTERISTICS (Note 4)

| | | | | | | |
|---------------------|--------------|---|--|------|--|----|
| Turn-On Delay Time | $t_{d(ON)}$ | $V_{GS} = 4.5\text{ V}, V_{DS} = 15\text{ V}, I_D = 15\text{ A}, R_G = 3.0\ \Omega$ | | 12.6 | | ns |
| Rise Time | t_r | | | 20.2 | | |
| Turn-Off Delay Time | $t_{d(OFF)}$ | | | 16.4 | | |
| Fall Time | t_f | | | 5.1 | | |

Product parametric performance is indicated in the Electrical Characteristics for the listed test conditions, unless otherwise noted. Product performance may not be indicated by the Electrical Characteristics if operated under different conditions.

3. Pulse Test: pulse width $\leq 300\ \mu\text{s}$, duty cycle $\leq 2\%$.
4. Switching characteristics are independent of operating junction temperatures.

NTD4858N

ELECTRICAL CHARACTERISTICS ($T_J = 25^\circ\text{C}$ unless otherwise specified) (continued)

| Parameter | Symbol | Test Condition | Min | Typ | Max | Unit |
|---|--------------|---|-----|------|-----|------|
| SWITCHING CHARACTERISTICS (Note 4) | | | | | | |
| Turn-On Delay Time | $t_{d(ON)}$ | $V_{GS} = 11.5\text{ V}, V_{DS} = 15\text{ V},$ $I_D = 15\text{ A}, R_G = 3.0\ \Omega$ | | 7.7 | | ns |
| Rise Time | t_r | | | 17.3 | | |
| Turn-Off Delay Time | $t_{d(OFF)}$ | | | 23.8 | | |
| Fall Time | t_f | | | 2.8 | | |

DRAIN-SOURCE DIODE CHARACTERISTICS

| | | | | | | | |
|-------------------------|----------|---|---------------------------|------|------|-----|---|
| Forward Diode Voltage | V_{SD} | $V_{GS} = 0\text{ V},$ $I_S = 30\text{ A}$ | $T_J = 25^\circ\text{C}$ | | 0.87 | 1.2 | V |
| | | | $T_J = 125^\circ\text{C}$ | | 0.73 | | |
| Reverse Recovery Time | t_{RR} | $V_{GS} = 0\text{ V}, dI_S/dt = 100\text{ A}/\mu\text{s},$ $I_S = 30\text{ A}$ | | 11.6 | | ns | |
| Charge Time | t_a | | | 7.8 | | | |
| Discharge Time | t_b | | | 3.7 | | | |
| Reverse Recovery Charge | Q_{RR} | | | 3.0 | | nC | |

PACKAGE PARASITIC VALUES

| | | | | | | |
|------------------------|-------|--------------------------|--|--------|--|----|
| Source Inductance | L_S | $T_A = 25^\circ\text{C}$ | | 2.49 | | nH |
| Drain Inductance, DPAK | L_D | | | 0.0164 | | |
| Drain Inductance, IPAK | L_D | | | 1.88 | | |
| Gate Inductance | L_G | | | 3.46 | | |
| Gate Resistance | R_G | | | 0.7 | | |

Product parametric performance is indicated in the Electrical Characteristics for the listed test conditions, unless otherwise noted. Product performance may not be indicated by the Electrical Characteristics if operated under different conditions.

3. Pulse Test: pulse width $\leq 300\ \mu\text{s}$, duty cycle $\leq 2\%$.

4. Switching characteristics are independent of operating junction temperatures.

TYPICAL PERFORMANCE CURVES

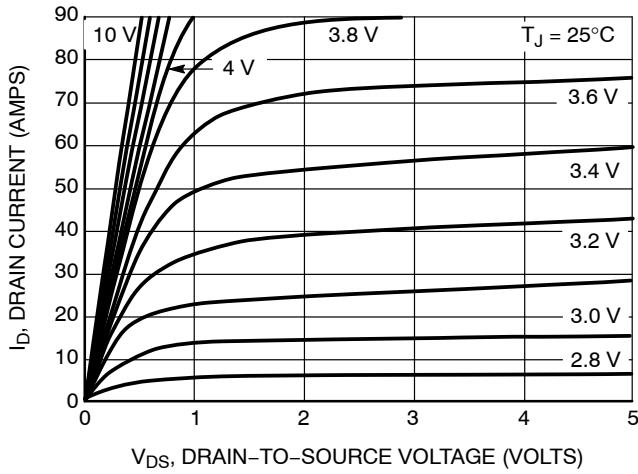

Figure 1. On-Region Characteristics

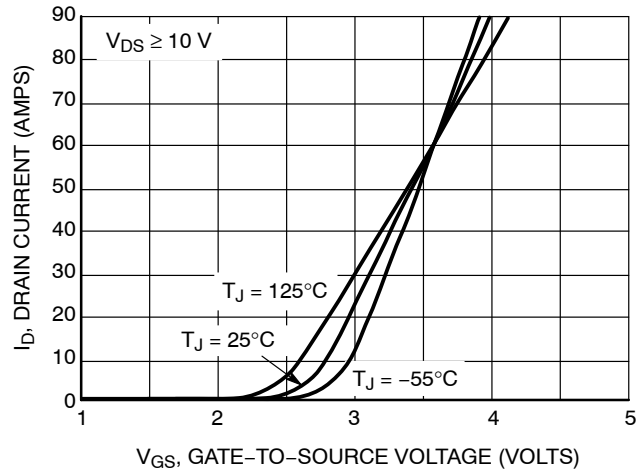

Figure 2. Transfer Characteristics

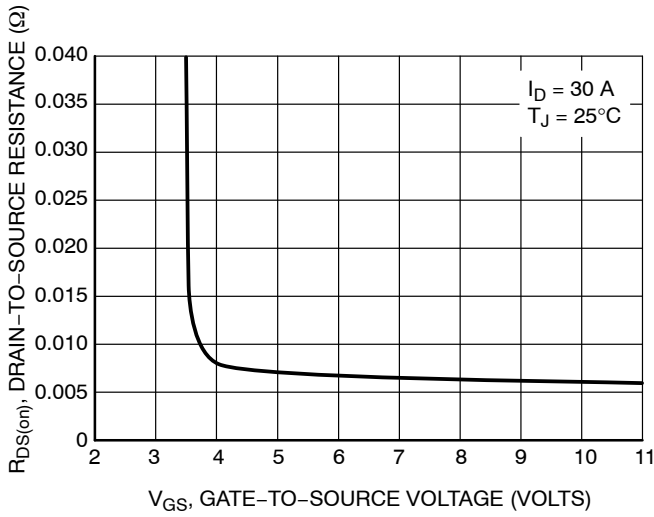

Figure 3. On-Resistance vs. Gate-to-Source Voltage

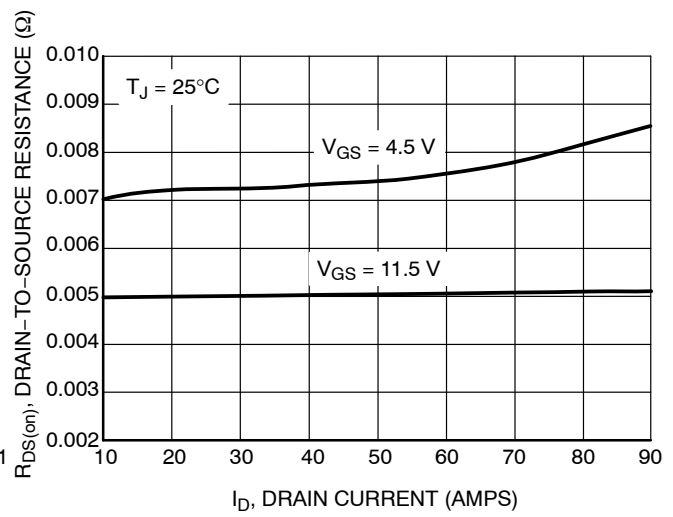

Figure 4. On-Resistance vs. Drain Current and Gate Voltage

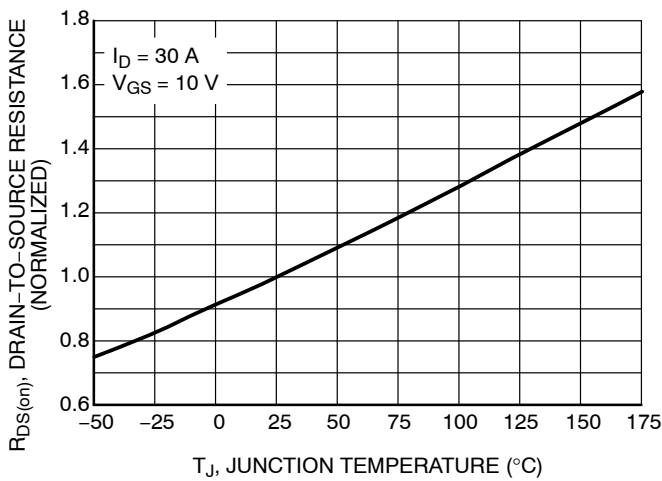

Figure 5. On-Resistance Variation with Temperature

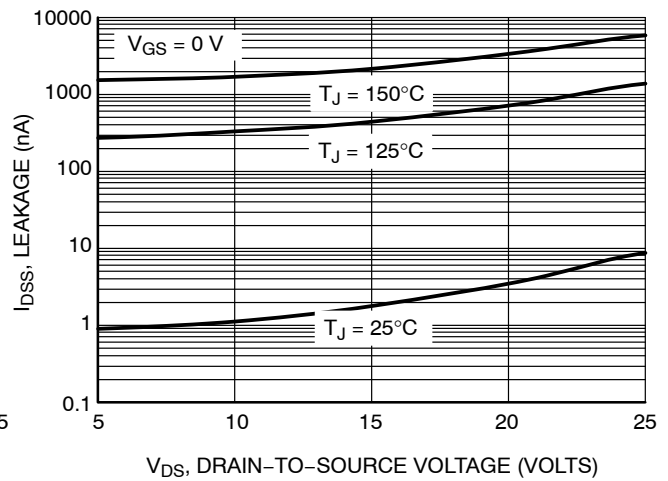

Figure 6. Drain-to-Source Leakage Current vs. Drain Voltage

TYPICAL PERFORMANCE CURVES

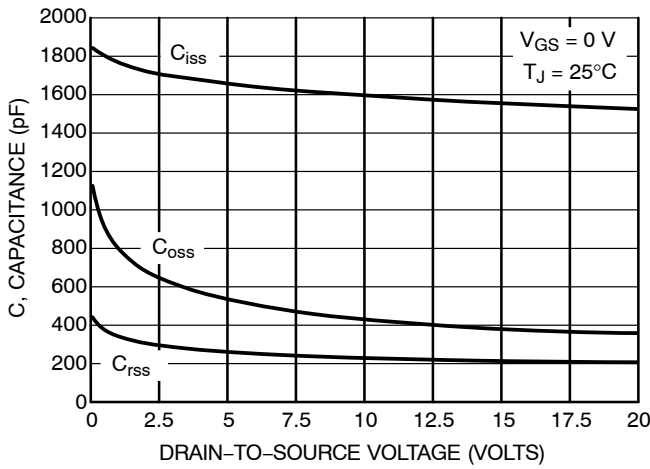

Figure 7. Capacitance Variation

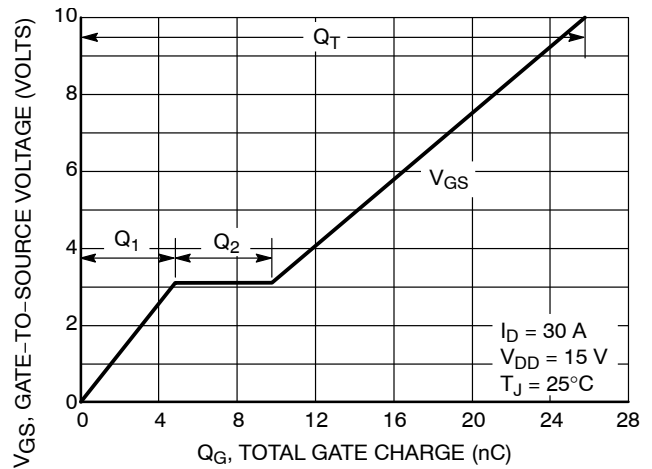

Figure 8. Gate-To-Source and Drain-To-Source Voltage vs. Total Charge

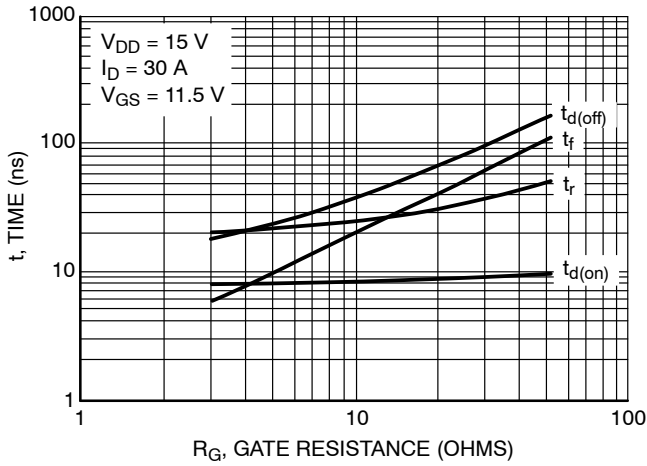

Figure 9. Resistive Switching Time Variation vs. Gate Resistance

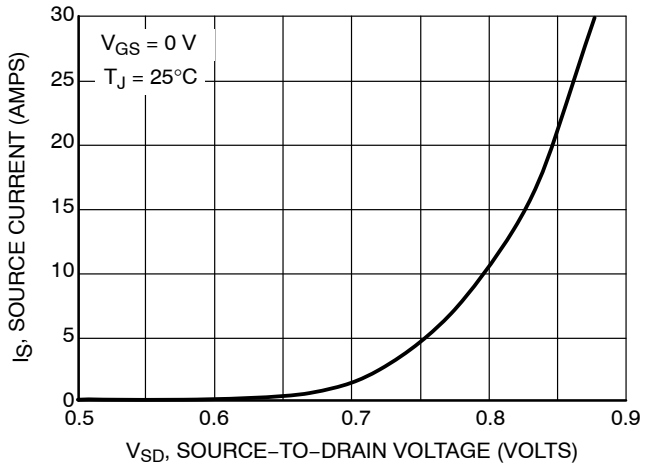

Figure 10. Diode Forward Voltage vs. Current

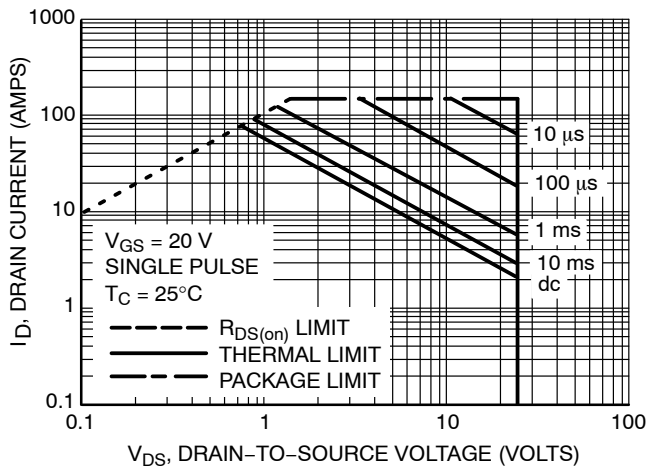

Figure 11. Maximum Rated Forward Biased Safe Operating Area

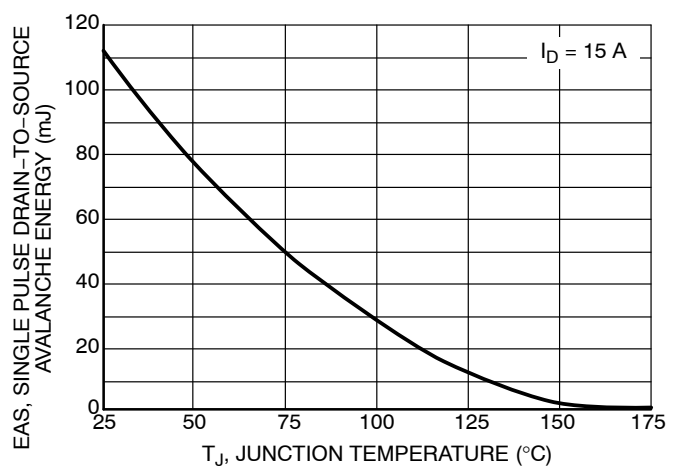

Figure 12. Maximum Avalanche Energy vs. Starting Junction Temperature

NTD4858N

TYPICAL PERFORMANCE CURVES

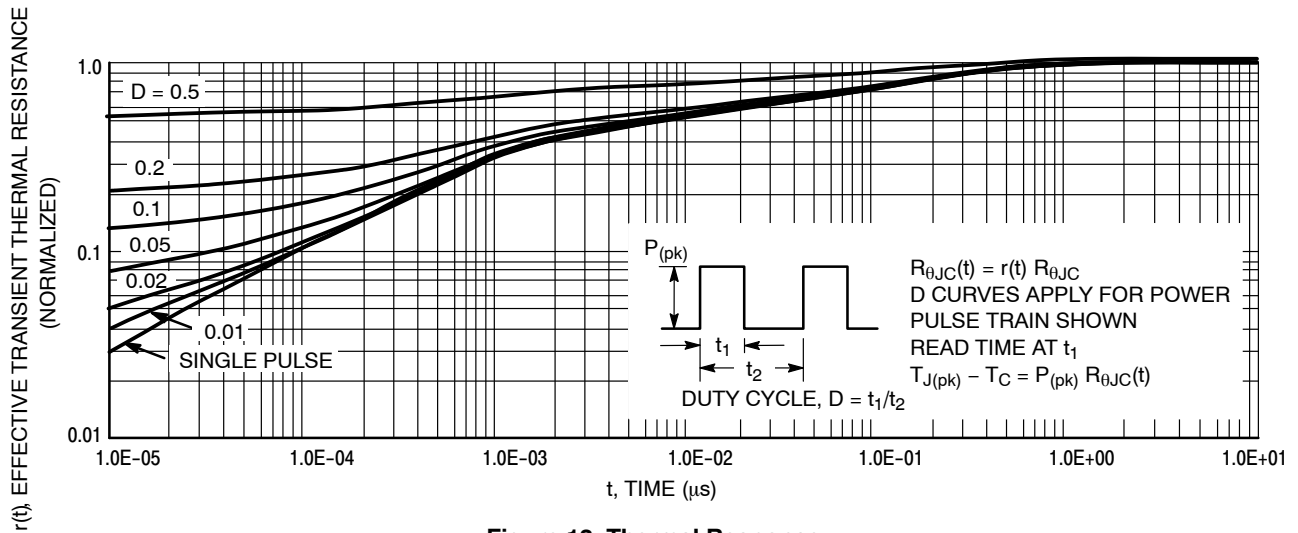

Figure 13. Thermal Response

ORDERING INFORMATION

| Device | Package | Shipping† |
|--------------|--|--------------------|
| NTD4858NT4G | DPAK (Pb-Free) | 2500 / Tape & Reel |
| NTD4858N-1G | IPAK (Pb-Free) | 75 Units / Rail |
| NTD4858N-35G | IPAK Trimmed Lead (3.5 ± 0.15 mm) (Pb-Free) | 75 Units / Rail |

†For information on tape and reel specifications, including part orientation and tape sizes, please refer to our Tape and Reel Packaging Specifications Brochure, BRD8011/D.

NTD4858N

PACKAGE DIMENSIONS

DPAK (SINGLE GUAGE) CASE 369AA ISSUE B

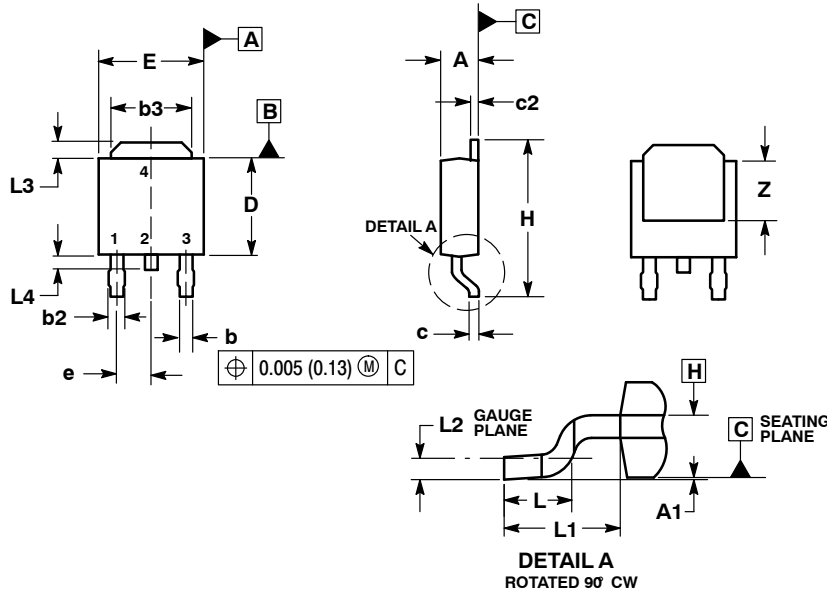

- NOTES:
1. DIMENSIONING AND TOLERANCING PER ASME Y14.5M, 1994.
 2. CONTROLLING DIMENSION: INCHES.
 3. THERMAL PAD CONTOUR OPTIONAL WITHIN DIMENSIONS b3, L3 and Z.
 4. DIMENSIONS D AND E DO NOT INCLUDE MOLD FLASH, PROTRUSIONS, OR BURRS. MOLD FLASH, PROTRUSIONS, OR GATE BURRS SHALL NOT EXCEED 0.006 INCHES PER SIDE.
 5. DIMENSIONS D AND E ARE DETERMINED AT THE OUTERMOST EXTREMES OF THE PLASTIC BODY.
 6. DATUMS A AND B ARE DETERMINED AT DATUM PLANE H.

| DIM | INCHES | | MILLIMETERS | |
|-----|-----------|-------|-------------|-------|
| | MIN | MAX | MIN | MAX |
| A | 0.086 | 0.094 | 2.18 | 2.38 |
| A1 | 0.000 | 0.005 | 0.00 | 0.13 |
| b | 0.025 | 0.035 | 0.63 | 0.89 |
| b2 | 0.030 | 0.045 | 0.76 | 1.14 |
| b3 | 0.180 | 0.215 | 4.57 | 5.46 |
| c | 0.018 | 0.024 | 0.46 | 0.61 |
| c2 | 0.018 | 0.024 | 0.46 | 0.61 |
| D | 0.235 | 0.245 | 5.97 | 6.22 |
| E | 0.250 | 0.265 | 6.35 | 6.73 |
| e | 0.090 BSC | | 2.29 BSC | |
| H | 0.370 | 0.410 | 9.40 | 10.41 |
| L | 0.055 | 0.070 | 1.40 | 1.78 |
| L1 | 0.108 REF | | 2.74 REF | |
| L2 | 0.020 BSC | | 0.51 BSC | |
| L3 | 0.035 | 0.050 | 0.89 | 1.27 |
| L4 | --- | 0.040 | --- | 1.01 |
| Z | 0.155 | --- | 3.93 | --- |

SOLDERING FOOTPRINT*

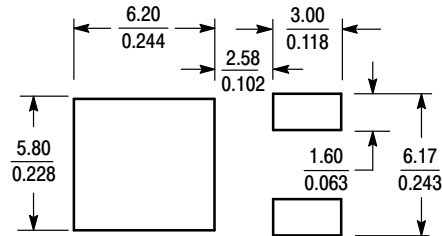

SCALE 3:1 (mm/inches)

- STYLE 2:
PIN 1. GATE
2. DRAIN
3. SOURCE
4. DRAIN

*For additional information on our Pb-Free strategy and soldering details, please download the ON Semiconductor Soldering and Mounting Techniques Reference Manual, SOLDERRM/D.

NTD4858N

PACKAGE DIMENSIONS

3.5 MM IPAK, STRAIGHT LEAD CASE 369AD ISSUE B

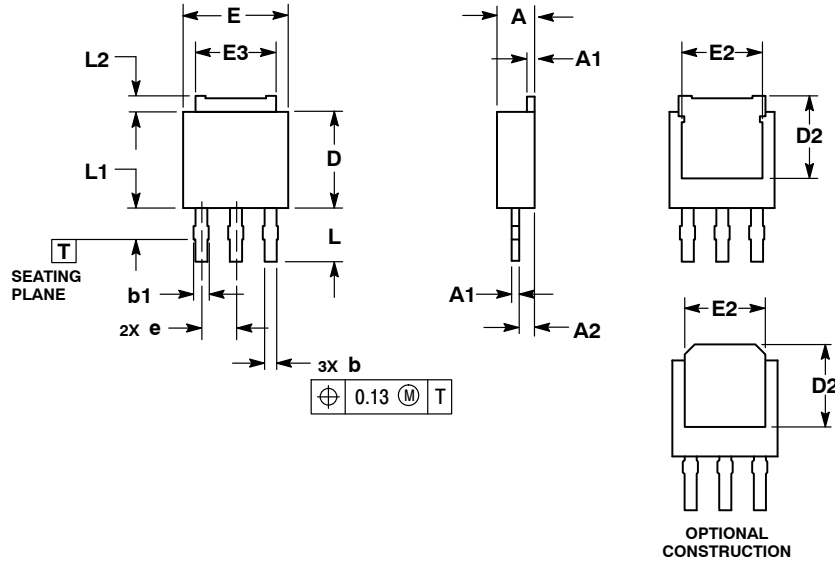

NOTES:

- 1.. DIMENSIONING AND TOLERANCING PER ASME Y14.5M, 1994.
- 2.. CONTROLLING DIMENSION: MILLIMETERS.
3. DIMENSION b APPLIES TO PLATED TERMINAL AND IS MEASURED BETWEEN 0.15 AND 0.30mm FROM TERMINAL TIP.
4. DIMENSIONS D AND E DO NOT INCLUDE MOLD GATE OR MOLD FLASH.

| DIM | MILLIMETERS | |
|-----|-------------|------|
| | MIN | MAX |
| A | 2.19 | 2.38 |
| A1 | 0.46 | 0.60 |
| A2 | 0.87 | 1.10 |
| b | 0.69 | 0.89 |
| b1 | 0.77 | 1.10 |
| D | 5.97 | 6.22 |
| D2 | 4.80 | --- |
| E | 6.35 | 6.73 |
| E2 | 4.57 | 5.45 |
| E3 | 4.45 | 5.46 |
| e | 2.28 | BSC |
| L | 3.40 | 3.60 |
| L1 | --- | 2.10 |
| L2 | 0.89 | 1.27 |

STYLE 2:

- PIN 1. GATE
2. DRAIN
3. SOURCE
4. DRAIN

NTD4858N

PACKAGE DIMENSIONS

IPAK CASE 369D ISSUE C

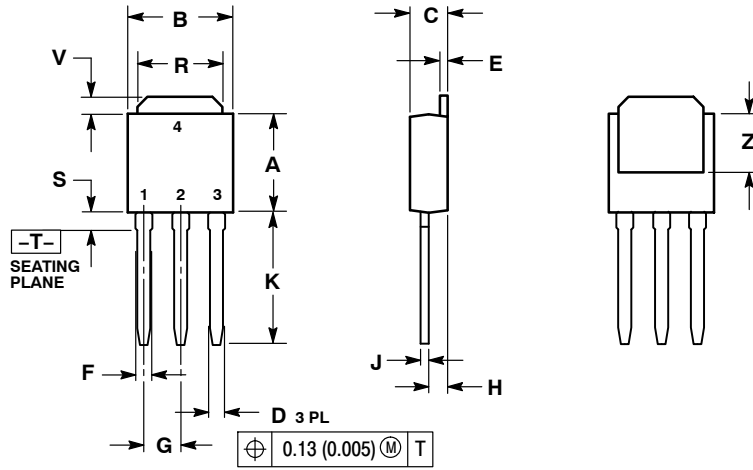

NOTES:

1. DIMENSIONING AND TOLERANCING PER ANSI Y14.5M, 1982.
2. CONTROLLING DIMENSION: INCH.

| DIM | INCHES | | MILLIMETERS | |
|-----|--------|-------|-------------|------|
| | MIN | MAX | MIN | MAX |
| A | 0.235 | 0.245 | 5.97 | 6.35 |
| B | 0.250 | 0.265 | 6.35 | 6.73 |
| C | 0.086 | 0.094 | 2.19 | 2.38 |
| D | 0.027 | 0.035 | 0.69 | 0.88 |
| E | 0.018 | 0.023 | 0.46 | 0.58 |
| F | 0.037 | 0.045 | 0.94 | 1.14 |
| G | 0.090 | BSC | 2.29 | BSC |
| H | 0.034 | 0.040 | 0.87 | 1.01 |
| J | 0.018 | 0.023 | 0.46 | 0.58 |
| K | 0.350 | 0.380 | 8.89 | 9.65 |
| R | 0.180 | 0.215 | 4.45 | 5.45 |
| S | 0.025 | 0.040 | 0.63 | 1.01 |
| V | 0.035 | 0.050 | 0.89 | 1.27 |
| Z | 0.155 | --- | 3.93 | --- |

STYLE 2:

- PIN 1. GATE
- DRAIN
- SOURCE
- DRAIN

ON Semiconductor and are registered trademarks of Semiconductor Components Industries, LLC (SCILLC). SCILLC owns the rights to a number of patents, trademarks, copyrights, trade secrets, and other intellectual property. A listing of SCILLC's product/patent coverage may be accessed at www.onsemi.com/site/pdf/Patent-Marking.pdf. SCILLC reserves the right to make changes without further notice to any products herein. SCILLC makes no warranty, representation or guarantee regarding the suitability of its products for any particular purpose, nor does SCILLC assume any liability arising out of the application or use of any product or circuit, and specifically disclaims any and all liability, including without limitation special, consequential or incidental damages. "Typical" parameters which may be provided in SCILLC data sheets and/or specifications can and do vary in different applications and actual performance may vary over time. All operating parameters, including "Typicals" must be validated for each customer application by customer's technical experts. SCILLC does not convey any license under its patent rights nor the rights of others. SCILLC products are not designed, intended, or authorized for use as components in systems intended for surgical implant into the body, or other applications intended to support or sustain life, or for any other application in which the failure of the SCILLC product could create a situation where personal injury or death may occur. Should Buyer purchase or use SCILLC products for any such unintended or unauthorized application, Buyer shall indemnify and hold SCILLC and its officers, employees, subsidiaries, affiliates, and distributors harmless against all claims, costs, damages, and expenses, and reasonable attorney fees arising out of, directly or indirectly, any claim of personal injury or death associated with such unintended or unauthorized use, even if such claim alleges that SCILLC was negligent regarding the design or manufacture of the part. SCILLC is an Equal Opportunity/Affirmative Action Employer. This literature is subject to all applicable copyright laws and is not for resale in any manner.

PUBLICATION ORDERING INFORMATION

LITERATURE FULFILLMENT:
Literature Distribution Center for ON Semiconductor
P.O. Box 5163, Denver, Colorado 80217 USA
Phone: 303-675-2175 or 800-344-3860 Toll Free USA/Canada
Fax: 303-675-2176 or 800-344-3867 Toll Free USA/Canada
Email: orderlit@onsemi.com

N. American Technical Support: 800-282-9855 Toll Free
USA/Canada
Europe, Middle East and Africa Technical Support:
Phone: 421 33 790 2910
Japan Customer Focus Center
Phone: 81-3-5817-1050

ON Semiconductor Website: www.onsemi.com
Order Literature: <http://www.onsemi.com/orderlit>
For additional information, please contact your local Sales Representative

Looking for pricing, stock, or lifecycle information?

Click below to explore more details on WIN SOURCE:

 [View NTD4858NT4G on WIN SOURCE](#)

 [ON Semiconductor](#) Information

Optimize Your Supply Chain with WIN SOURCE Solutions

-  Global Sourcing Solution
-  Obsolete Management
-  Cost Control Management
-  Shortage Management
-  Alternative Solution
-  Excess Inventory Management