



**THE DATASHEET OF  
NTHS2101PT1G**



# NTHS2101P

## Power MOSFET

-8.0 V, -7.5 A P-Channel ChipFET™

### Features

- Offers an Ultra Low  $R_{DS(on)}$  Solution in the ChipFET Package
- Miniature ChipFET Package 40% Smaller Footprint than TSOP-6 making it an Ideal Device for Applications where Board Space is at a Premium
- Low Profile (<1.1 mm) Allows it to Fit Easily into Extremely Thin Environments such as Portable Electronics
- Designed to Provide Low  $R_{DS(on)}$  at Gate Voltage as Low as 1.8 V, the Operating Voltage used in many Logic ICs in Portable Electronics
- Simplifies Circuit Design since Additional Boost Circuits for Gate Voltages are not Required
- Operated at Standard Logic Level Gate Drive, Facilitating Future Migration to Lower Levels using the same Basic Topology
- Pb-Free Package is Available

### Applications

- Optimized for Battery and Load Management Applications in Portable Equipment such as MP3 Players, Cell Phones, Digital Cameras, Personal Digital Assistant and other Portable Applications
- Charge Control in Battery Chargers
- Buck and Boost Converters

### MAXIMUM RATINGS ( $T_J = 25^\circ\text{C}$ unless otherwise noted)

Rating	Symbol	Value	Unit
Drain-to-Source Voltage	$V_{DSS}$	-8.0	$V_{dc}$
Gate-to-Source Voltage – Continuous	$V_{GS}$	$\pm 8.0$	$V_{dc}$
Drain Current – Continuous – 5 seconds	$I_D$	-5.4 -7.5	A
Total Power Dissipation Continuous @ $T_A = 25^\circ\text{C}$ (5 sec) @ $T_A = 25^\circ\text{C}$ Continuous @ $85^\circ\text{C}$ (5 sec) @ $85^\circ\text{C}$	$P_D$	1.3 2.5 0.7 1.3	W
Continuous Source Current	$I_S$	-1.1	A
Thermal Resistance (Note 1) Junction-to-Ambient, 5 sec Junction-to-Ambient, Continuous	$R_{\theta JA}$	50 95	$^\circ\text{C/W}$
Maximum Lead Temperature for Soldering Purposes, 1/8" from case for 10 seconds	$T_L$	260	$^\circ\text{C}$

Maximum ratings are those values beyond which device damage can occur. Maximum ratings applied to the device are individual stress limit values (not normal operating conditions) and are not valid simultaneously. If these limits are exceeded, device functional operation is not implied, damage may occur and reliability may be affected.

1. Surface Mounted on FR4 Board using 1 in sq pad size (Cu area = 1.27 in sq [1 oz] including traces).



ON Semiconductor®

<http://onsemi.com>

$V_{(BR)DSS}$	Ultra Low $R_{DS(on)}$ TYP	$I_D$ MAX
-8.0 V	19 m $\Omega$ @ -4.5 $V_{GS}$	-7.5 A
	25 m $\Omega$ @ -2.5 $V_{GS}$	
	34 m $\Omega$ @ -1.8 $V_{GS}$	

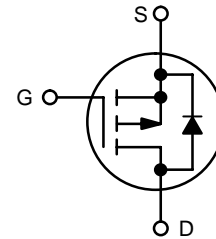

P-Channel MOSFET

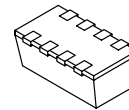

ChipFET  
CASE 1206A  
STYLE 1

### PIN CONNECTIONS

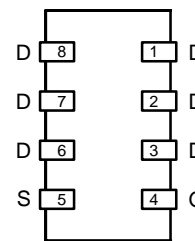

### MARKING DIAGRAM

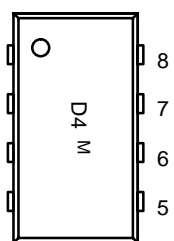

D4 = Specific Device Code  
M = Month Code

### ORDERING INFORMATION

Device	Package	Shipping†
NTHS2101PT1	ChipFET	3000/Tape & Reel
NTHS2101PT1G	ChipFET (Pb-Free)	3000/Tape & Reel

†For information on tape and reel specifications, including part orientation and tape sizes, please refer to our Tape and Reel Packaging Specifications Brochure, BRD8011/D.

# NTHS2101P

## ELECTRICAL CHARACTERISTICS (T<sub>J</sub> = 25°C unless otherwise noted)

Characteristic	Symbol	Test Condition	Min	Typ	Max	Unit
----------------	--------	----------------	-----	-----	-----	------

### OFF CHARACTERISTICS

Drain-to-Source Breakdown Voltage (Note 2) Temperature Coefficient (Positive)	V <sub>(Br)DSS</sub>	V <sub>GS</sub> = 0 V <sub>dc</sub> , I <sub>D</sub> = -250 μA <sub>dc</sub>	-8.0			V <sub>dc</sub>
Gate-Body Leakage Current Zero	I <sub>GSS</sub>	V <sub>DS</sub> = 0 V <sub>dc</sub> , V <sub>GS</sub> = ±8.0 V <sub>dc</sub>			± 100	nA <sub>dc</sub>
Zero Gate Voltage Drain Current	I <sub>DSS</sub>	V <sub>DS</sub> = -6.4 V <sub>dc</sub> , V <sub>GS</sub> = 0 V <sub>dc</sub> V <sub>DS</sub> = -6.4 V <sub>dc</sub> , V <sub>GS</sub> = 0 V <sub>dc</sub> , T <sub>J</sub> = 85°C			-1.0 -5.0	μA <sub>dc</sub>

### ON CHARACTERISTICS (Note 2)

Gate Threshold Voltage	V <sub>GS(th)</sub>	V <sub>DS</sub> = V <sub>GS</sub> , I <sub>D</sub> = -250 μA <sub>dc</sub>	-0.45		-1.5	V <sub>dc</sub>
Static Drain-to-Source On-Resistance	R <sub>DS(on)</sub>	V <sub>GS</sub> = -4.5 V <sub>dc</sub> , I <sub>D</sub> = -5.4 A <sub>dc</sub> V <sub>GS</sub> = -2.5 V <sub>dc</sub> , I <sub>D</sub> = -4.5 A <sub>dc</sub> V <sub>GS</sub> = -1.8 V <sub>dc</sub> , I <sub>D</sub> = -2.0 A <sub>dc</sub>		19 25 34	25 36 48	mΩ
Forward Transconductance	g <sub>FS</sub>	V <sub>DS</sub> = -5.0 V <sub>dc</sub> , I <sub>D</sub> = -5.2 A <sub>dc</sub>		20		S
Diode Forward Voltage	V <sub>SD</sub>	I <sub>S</sub> = -1.1 A <sub>dc</sub> , V <sub>GS</sub> = 0 V <sub>dc</sub>		-0.62	-1.2	V

### DYNAMIC CHARACTERISTIC

Input Capacitance	C <sub>iss</sub>	V <sub>DS</sub> = -6.4 V <sub>dc</sub> V <sub>GS</sub> = 0 V f = 1.0 MHz		2400		pF
Output Capacitance	C <sub>oss</sub>			550		
Transfer Capacitance	C <sub>rss</sub>			420		

### SWITCHING CHARACTERISTICS (Note 3)

Turn-On Delay Time	t <sub>d(on)</sub>	V <sub>DD</sub> = -6.4 V <sub>dc</sub> V <sub>GS</sub> = -4.5 V <sub>dc</sub> I <sub>D</sub> = -5.4 A <sub>dc</sub> R <sub>G</sub> = 2.0 Ω (Note 2)		7.0		ns
Rise Time	t <sub>r</sub>			28		
Turn-Off Delay Time	t <sub>d(off)</sub>			73		
Fall Time	t <sub>f</sub>			60		
Gate Charge	Q <sub>G</sub>	V <sub>GS</sub> = -4.5 V <sub>dc</sub> I <sub>D</sub> = -5.4 A <sub>dc</sub> V <sub>DS</sub> = -6.4 V <sub>dc</sub>		15	30	nC
	Q <sub>GS</sub>			4.0		
	Q <sub>GD</sub>			8.0		
Source-Drain Reverse Recovery Time	T <sub>rr</sub>	I <sub>F</sub> = -1.1 A, di/dt = 100 A/μs		90		ns

2. Pulse Test: Pulse Width = 250 μs, Duty Cycle = 2%.

3. Switching characteristics are independent of operating junction temperatures.

TYPICAL ELECTRICAL CHARACTERISTICS

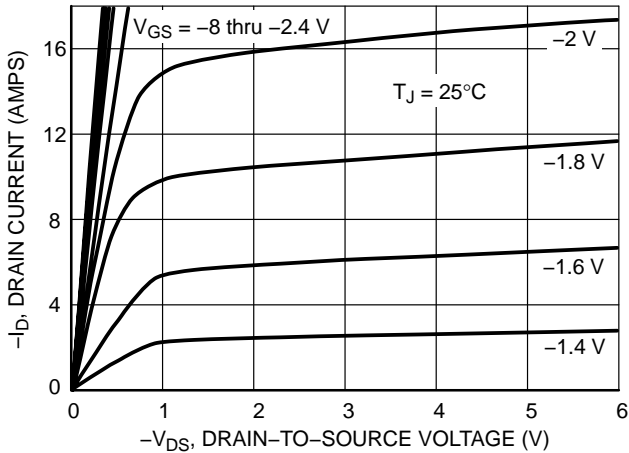

Figure 1. On-Region Characteristics

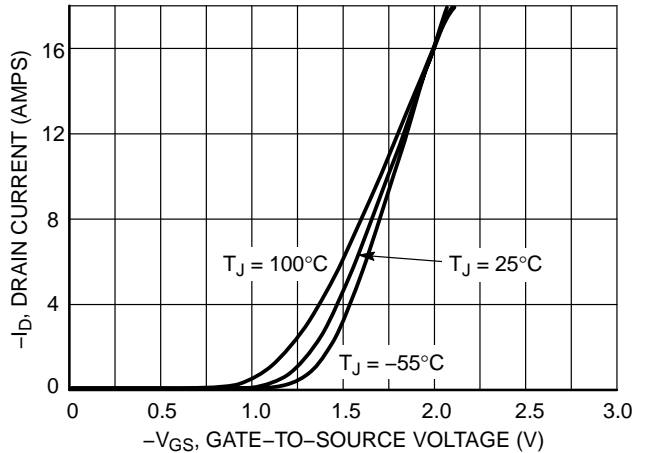

Figure 2. Transfer Characteristics

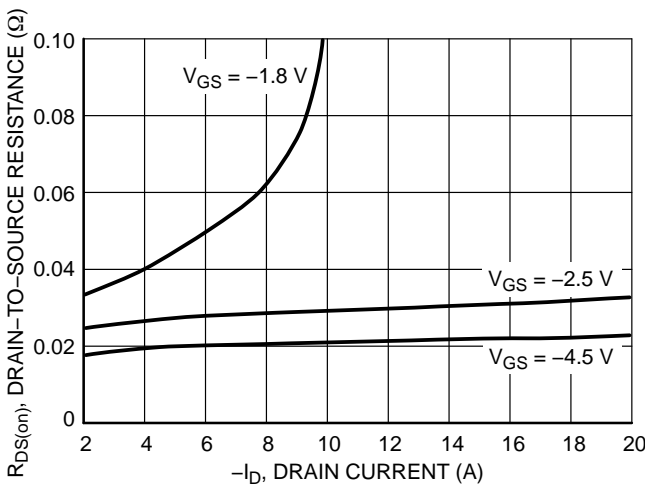

Figure 3. On-Resistance versus Drain Current and Gate Voltage

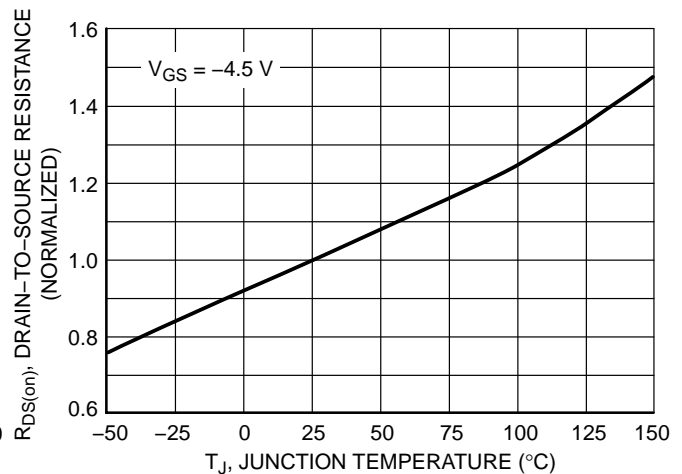

Figure 4. On-Resistance Variation with Temperature

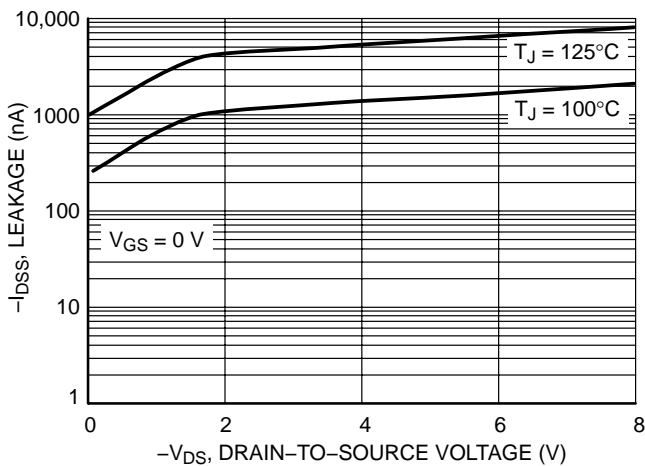

Figure 5. Drain-to-Source Leakage Current vs. Voltage

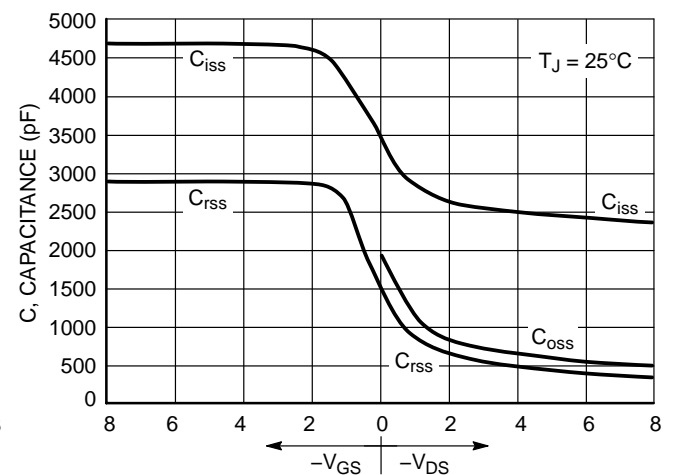

Figure 6. Capacitance Variation

TYPICAL ELECTRICAL CHARACTERISTICS

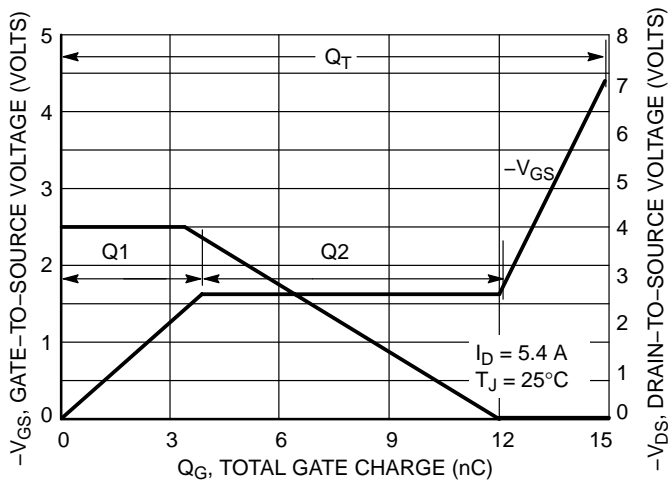

Figure 7. Gate-to-Source and Drain-to-Source Voltage vs. Total Charge

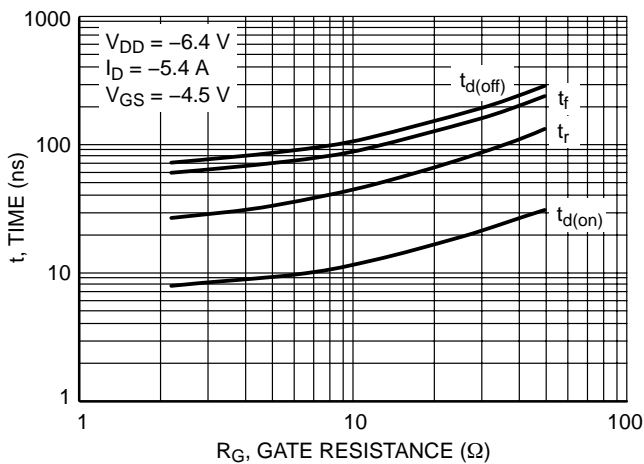

Figure 8. Resistive Switching Time Variation vs. Gate Resistance

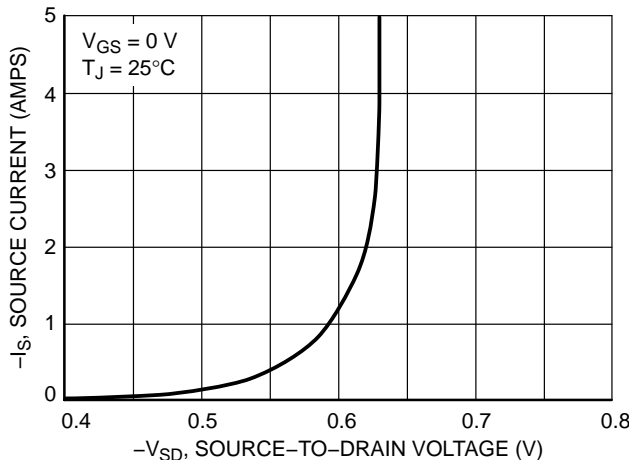

Figure 9. Diode Forward Voltage vs. Current

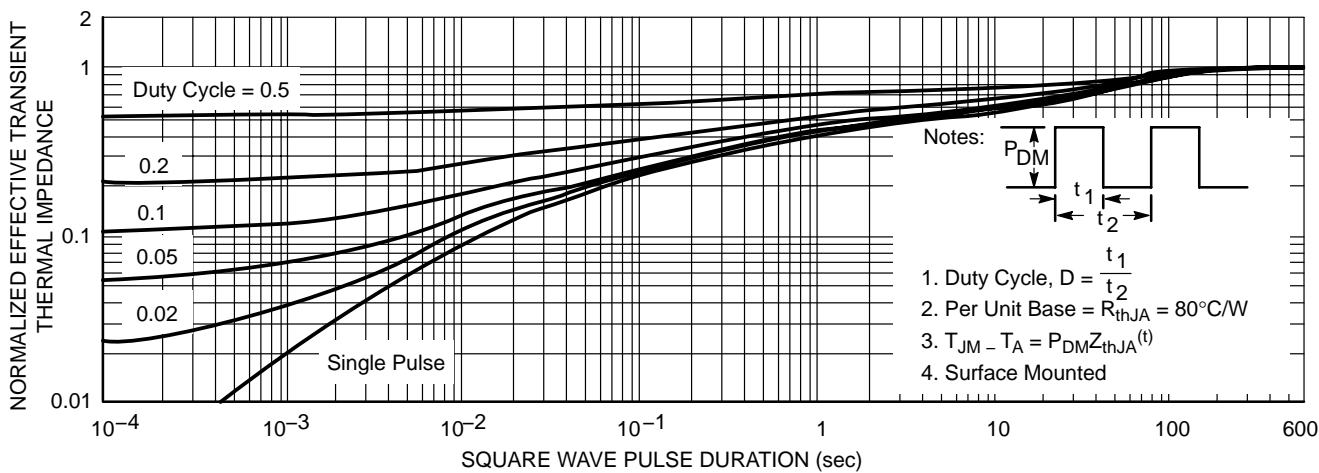
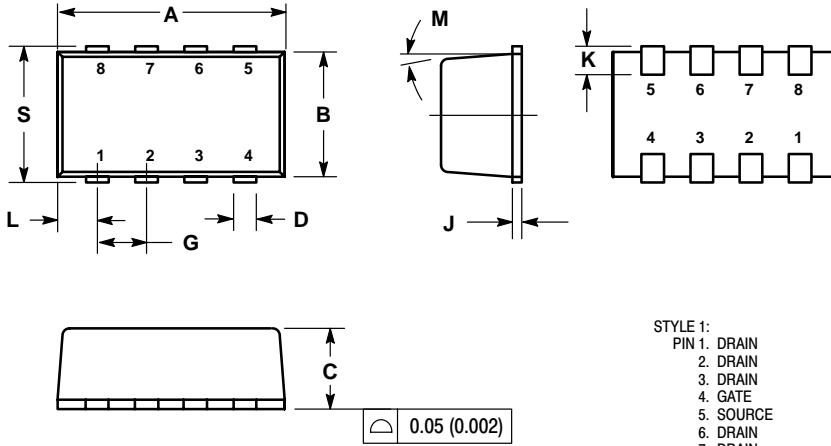

Figure 10. Normalized Thermal Transient Impedance, Junction-to-Ambient

# NTHS2101P

## PACKAGE DIMENSIONS

ChipFET  
CASE 1206A-03  
ISSUE E



**NOTES:**

1. DIMENSIONING AND TOLERANCING PER ANSI Y14.5M, 1982.
2. CONTROLLING DIMENSION: MILLIMETER.
3. MOLD GATE BURRS SHALL NOT EXCEED 0.13 MM PER SIDE.
4. LEADFRAME TO MOLDED BODY OFFSET IN HORIZONTAL AND VERTICAL SHALL NOT EXCEED 0.08 MM.
5. DIMENSIONS A AND B EXCLUSIVE OF MOLD GATE BURRS.
6. NO MOLD FLASH ALLOWED ON THE TOP AND BOTTOM LEAD SURFACE.
7. 1206A-01 AND 1206A-02 OBSOLETE. NEW STANDARD IS 1206A-03.

DIM	MILLIMETERS		INCHES	
	MIN	MAX	MIN	MAX
A	2.95	3.10	0.116	0.122
B	1.55	1.70	0.061	0.067
C	1.00	1.10	0.039	0.043
D	0.25	0.35	0.010	0.014
G	0.65 BSC		0.025 BSC	
J	0.10	0.20	0.004	0.008
K	0.28	0.42	0.011	0.017
L	0.55 BSC		0.022 BSC	
M	5° NOM		5° NOM	
S	1.80	2.00	0.072	0.080

**STYLE 1:**

1. DRAIN
2. DRAIN
3. DRAIN
4. GATE
5. SOURCE
6. DRAIN
7. DRAIN
8. DRAIN

## SOLDERING FOOTPRINTS\*

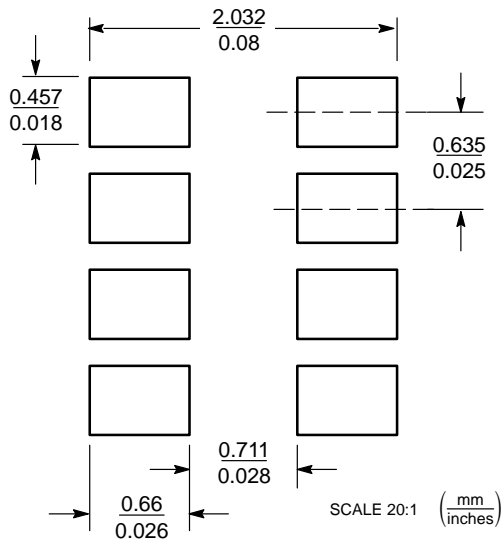

**Basic**

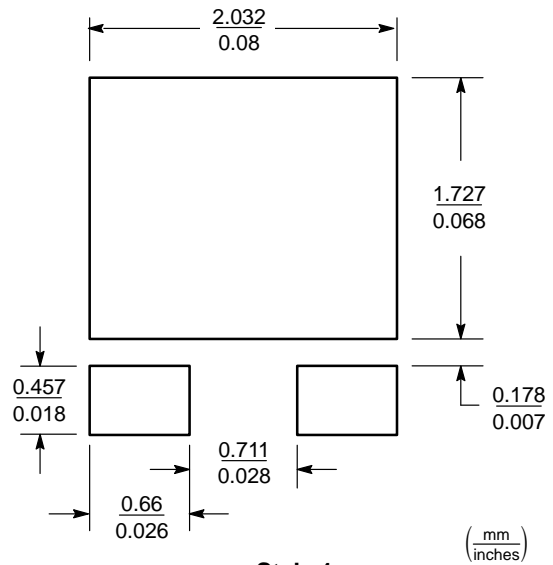

**Style 1**

\*For additional information on our Pb-Free strategy and soldering details, please download the ON Semiconductor Soldering and Mounting Techniques Reference Manual, SOLDERRM/D.

ChipFET is a trademark of Vishay Siliconix.

**ON Semiconductor** and  are registered trademarks of Semiconductor Components Industries, LLC (SCILLC). SCILLC reserves the right to make changes without further notice to any products herein. SCILLC makes no warranty, representation or guarantee regarding the suitability of its products for any particular purpose, nor does SCILLC assume any liability arising out of the application or use of any product or circuit, and specifically disclaims any and all liability, including without limitation special, consequential or incidental damages. "Typical" parameters which may be provided in SCILLC data sheets and/or specifications can and do vary in different applications and actual performance may vary over time. All operating parameters, including "Typicals" must be validated for each customer application by customer's technical experts. SCILLC does not convey any license under its patent rights nor the rights of others. SCILLC products are not designed, intended, or authorized for use as components in systems intended for surgical implant into the body, or other applications intended to support or sustain life, or for any other application in which the failure of the SCILLC product could create a situation where personal injury or death may occur. Should Buyer purchase or use SCILLC products for any such unintended or unauthorized application, Buyer shall indemnify and hold SCILLC and its officers, employees, subsidiaries, affiliates, and distributors harmless against all claims, costs, damages, and expenses, and reasonable attorney fees arising out of, directly or indirectly, any claim of personal injury or death associated with such unintended or unauthorized use, even if such claim alleges that SCILLC was negligent regarding the design or manufacture of the part. SCILLC is an Equal Opportunity/Affirmative Action Employer. This literature is subject to all applicable copyright laws and is not for resale in any manner.

## PUBLICATION ORDERING INFORMATION

### LITERATURE FULFILLMENT:

Literature Distribution Center for ON Semiconductor  
P.O. Box 61312, Phoenix, Arizona 85082-1312 USA  
**Phone:** 480-829-7710 or 800-344-3860 Toll Free USA/Canada  
**Fax:** 480-829-7709 or 800-344-3867 Toll Free USA/Canada  
**Email:** [orderlit@onsemi.com](mailto:orderlit@onsemi.com)

**N. American Technical Support:** 800-282-9855 Toll Free  
USA/Canada

**Japan:** ON Semiconductor, Japan Customer Focus Center  
2-9-1 Kamimeguro, Meguro-ku, Tokyo, Japan 153-0051  
**Phone:** 81-3-5773-3850



**ON Semiconductor Website:** <http://onsemi.com>

**Order Literature:** <http://www.onsemi.com/litorder>

For additional information, please contact your  
local Sales Representative.

## Looking for pricing, stock, or lifecycle information?

Click below to explore more details on WIN SOURCE:

-  [View NTHS2101PT1G on WIN SOURCE](#)
-  [ON Semiconductor Information](#)

## Optimize Your Supply Chain with WIN SOURCE Solutions

-  Global Sourcing Solution
-  Obsolete Management
-  Cost Control Management
-  Shortage Management
-  Alternative Solution
-  Excess Inventory Management