



**THE DATASHEET OF
NTJD4105CT1G**



NTJD4105C

MOSFET – Small Signal, Complementary, SC-88 20 V / -8.0 V, +0.63 A / -0.775 A

Features

- Complementary N and P Channel Device
- Leading -8.0 V Trench for Low $R_{DS(on)}$ Performance
- ESD Protected Gate – ESD Rating: Class 1
- SC-88 Package for Small Footprint (2 x 2 mm)
- Pb-Free Packages are Available

Applications

- DC-DC Conversion
- Load/Power Switching
- Single or Dual Cell Li-Ion Battery Supplied Devices
- Cell Phones, MP3s, Digital Cameras, PDAs

MAXIMUM RATINGS ($T_J = 25^\circ\text{C}$ unless otherwise noted)

Parameter	Symbol	Value	Unit	
Drain-to-Source Voltage	N-Ch	V_{DSS}	20	V
	P-Ch		-8.0	
Gate-to-Source Voltage	N-Ch	V_{GS}	± 12	V
	P-Ch		± 8.0	
Continuous Drain Current – Steady State (Based on $R_{\theta JA}$)	N-Ch	$T_A = 25^\circ\text{C}$	0.63	A
		$T_A = 85^\circ\text{C}$	0.46	
	P-Ch	$T_A = 25^\circ\text{C}$	-0.775	
		$T_A = 85^\circ\text{C}$	-0.558	
Continuous Drain Current – Steady State (Based on $R_{\theta JL}$)	N-Ch	$T_A = 25^\circ\text{C}$	0.91	
		$T_A = 85^\circ\text{C}$	0.65	
	P-Ch	$T_A = 25^\circ\text{C}$	-1.1	
		$T_A = 85^\circ\text{C}$	-0.8	
Pulsed Drain Current	$tp \leq 10 \mu\text{s}$	I_{DM}	± 1.2	A
Power Dissipation – Steady State (Based on $R_{\theta JA}$)	$T_A = 25^\circ\text{C}$	P_D	0.27	W
	$T_A = 85^\circ\text{C}$		0.14	
Power Dissipation – Steady State (Based on $R_{\theta JL}$)	$T_A = 25^\circ\text{C}$		0.55	
	$T_A = 85^\circ\text{C}$		0.29	
Operating Junction and Storage Temperature	T_J, T_{STG}	-55 to 150		$^\circ\text{C}$
Source Current (Body Diode)	N-Ch	I_S	0.63	A
	P-Ch		-0.775	
Lead Temperature for Soldering Purposes (1/8" from case for 10 s)	T_L	260		$^\circ\text{C}$

THERMAL RESISTANCE RATINGS (Note 1)

Parameter	Typ	Max	Unit	
Junction-to-Ambient – Steady State	Typ	$R_{\theta JA}$	400	$^\circ\text{C}/\text{W}$
	Max		460	
Junction-to-Lead (Drain) – Steady State	Typ	$R_{\theta JL}$	194	
	Max		226	

Stresses exceeding Maximum Ratings may damage the device. Maximum Ratings are stress ratings only. Functional operation above the Recommended Operating Conditions is not implied. Extended exposure to stresses above the Recommended Operating Conditions may affect device reliability.

1. Surface mounted on FR4 board using 1 oz Cu area = 0.9523 in sq.



ON Semiconductor®

<http://onsemi.com>

$V_{(BR)DSS}$	$R_{DS(on)}$ TYP	I_D Max
N-Ch 20 V	0.29 Ω @ 4.5 V	0.63 A
	0.36 Ω @ 2.5 V	
P-Ch -8.0 V	0.22 Ω @ -4.5 V	-0.775 A
	0.32 Ω @ -2.5 V	
	0.51 Ω @ -1.8 V	

SOT-363 SC-88 (6-LEADS)

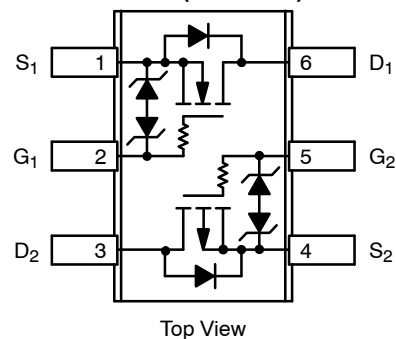

Top View

MARKING DIAGRAM & PIN ASSIGNMENT

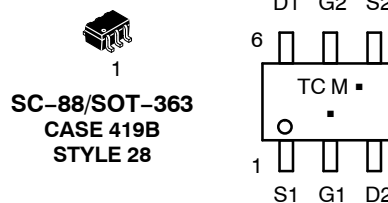

SC-88/SOT-363
CASE 419B
STYLE 28

TC = Device Code
M = Date Code
▪ = Pb-Free Package

(Note: Microdot may be in either location)

ORDERING INFORMATION

See detailed ordering and shipping information in the package dimensions section on page 7 of this data sheet.

NTJD4105C

ELECTRICAL CHARACTERISTICS (T_J = 25°C unless otherwise noted)

Parameter	Symbol	N/P	Test Condition	Min	Typ	Max	Units	
OFF CHARACTERISTICS								
Drain-to-Source Breakdown Voltage	V _{(BR)DSS}	N	V _{GS} = 0 V	I _D = 250 μA	20	27	V	
		P		I _D = -250 μA	-8.0	-10.5		
Drain-to-Source Breakdown Voltage Temperature Coefficient	V _{(BR)DSS} / T _J	N				22	mV/°C	
		P						-6.0
Zero Gate Voltage Drain Current	I _{DSS}	N	V _{GS} = 0 V, V _{DS} = 16 V	T _J = 25 °C			1.0	μA
		P	V _{GS} = 0 V, V _{DS} = -6.4 V				1.0	
Gate-to-Source Leakage Current	I _{GSS}	N	V _{DS} = 0 V	V _{GS} = ±12 V			10	μA
		P			V _{GS} = ±8.0			

ON CHARACTERISTICS (Note 2)

Gate Threshold Voltage	V _{GS(TH)}	N	V _{GS} = V _{DS}	I _D = 250 μA	0.6	0.92	1.5	V
		P		I _D = -250 μA	-0.45	-0.83	-1.0	
Gate Threshold Temperature Coefficient	V _{GS(TH)} / T _J	N				-2.1		-mV/°C
		P					2.2	
Drain-to-Source On Resistance	R _{DS(on)}	N	V _{GS} = 4.5 V, I _D = 0.63 A			0.29	0.375	Ω
		P	V _{GS} = -4.5 V, I _D = -0.57 A			0.22	0.30	
		N	V _{GS} = 2.5 V, I _D = 0.40 A			0.36	0.445	
		P	V _{GS} = -2.5 V, I _D = -0.48 A			0.32	0.46	
		P	V _{GS} = -1.8 V, I _D = -0.20 A			0.51	0.90	
Forward Transconductance	g _{FS}	N	V _{DS} = 4.0 V, I _D = 0.63 A			2.0		S
		P	V _{DS} = -4.0 V, I _D = -0.57 A			2.0		

CHARGES AND CAPACITANCES

Input Capacitance	C _{ISS}	N	f = 1 MHz, V _{GS} = 0 V	V _{DS} = 20 V		33	46	pF	
		P		V _{DS} = -8.0V		160	225		
Output Capacitance	C _{OSS}	N		V _{DS} = 20 V		13	22		
		P		V _{DS} = -8.0 V		38	55		
Reverse Transfer Capacitance	C _{RSS}	N		V _{DS} = 20 V		2.8	5.0		
		P		V _{DS} = -8.0 V		28	40		
Total Gate Charge	Q _{G(TOT)}	N		V _{GS} = 4.5 V, V _{DS} = 10 V, I _D = 0.7 A		1.3	3.0		nC
		P		V _{GS} = -4.5 V, V _{DS} = -5.0 V, I _D = -0.6 A		2.2	4.0		
Threshold Gate Charge	Q _{G(TH)}	N		V _{GS} = 4.5 V, V _{DS} = 10 V, I _D = 0.7 A		0.1			
		P		V _{GS} = -4.5 V, V _{DS} = -5.0 V, I _D = -0.6 A		0.1			
Gate-to-Source Charge	Q _{GS}	N	V _{GS} = 4.5 V, V _{DS} = 10 V, I _D = 0.7 A		0.2				
		P	V _{GS} = -4.5 V, V _{DS} = -5.0 V, I _D = -0.6 A		0.5				
Gate-to-Drain Charge	Q _{GD}	N	V _{GS} = 4.5 V, V _{DS} = 10 V, I _D = 0.7 A		0.4				
		P	V _{GS} = -4.5 V, V _{DS} = -5.0 V, I _D = -0.6 A		0.5				

SWITCHING CHARACTERISTICS (Note 3)

Turn-On Delay Time	t _{d(ON)}	N	V _{GS} = 4.5 V, V _{DD} = 10 V, I _D = 0.5 A, R _G = 20 Ω		0.083		μs
Rise Time	t _r				0.227		
Turn-Off Delay Time	t _{d(OFF)}				0.786		
Fall Time	t _f				0.506		
Turn-On Delay Time	t _{d(ON)}	P	V _{GS} = -4.5 V, V _{DD} = -4.0 V, I _D = -0.5 A, R _G = 8.0 Ω		0.013		
Rise Time	t _r				0.023		
Turn-Off Delay Time	t _{d(OFF)}				0.050		
Fall Time	t _f				0.036		

DRAIN-SOURCE DIODE CHARACTERISTICS

Forward Diode Voltage	V _{SD}	N	V _{GS} = 0 V, T _J = 25°C	I _S = 0.23 A		0.76	1.1	V
		P		I _S = -0.23 A		0.76	1.1	
		N	V _{GS} = 0 V, T _J = 125°C	I _S = 0.23 A		0.63		
		P		I _S = -0.23 A		0.63		
Reverse Recovery Time	t _{RR}	N	V _{GS} = 0 V, d _{IS} /d _t = 90 A/μs	I _S = 0.23 A		0.410		μs
		P		I _S = -0.23 A		0.078		

2. Pulse Test: pulse width ≤ 300 μs, duty cycle ≤ 2%.

3. Switching characteristics are independent of operating junction temperatures.

NTJD4105C

TYPICAL N-CHANNEL PERFORMANCE CURVES ($T_J = 25^\circ\text{C}$ unless otherwise noted)

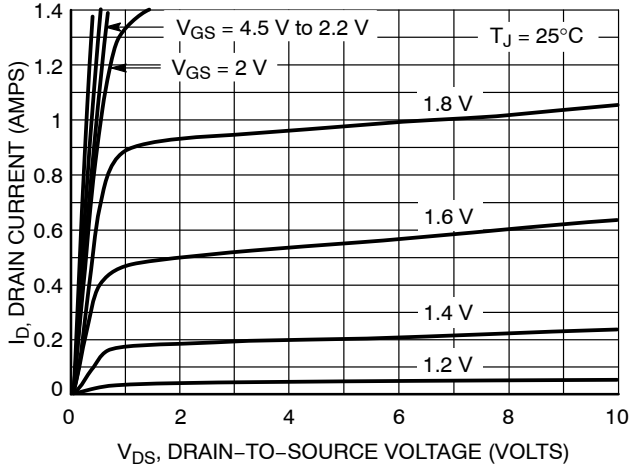

Figure 1. On-Region Characteristics

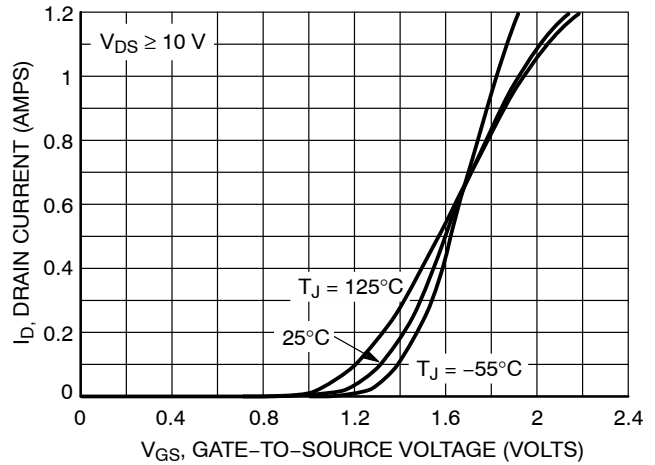

Figure 2. Transfer Characteristics

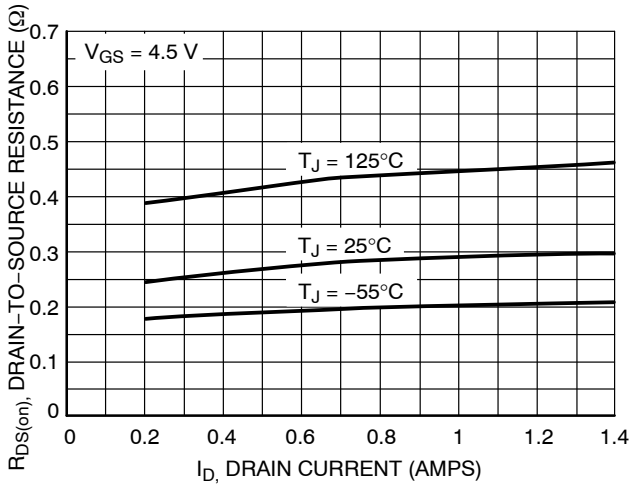

Figure 3. On-Resistance vs. Drain Current and Temperature

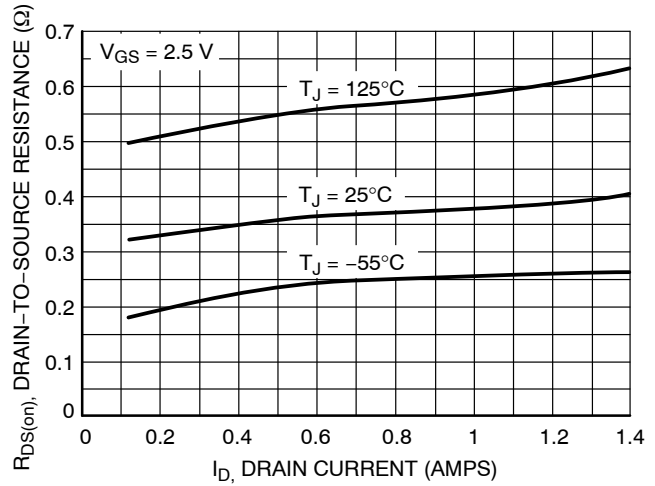

Figure 4. On-Resistance vs. Drain Current and Temperature

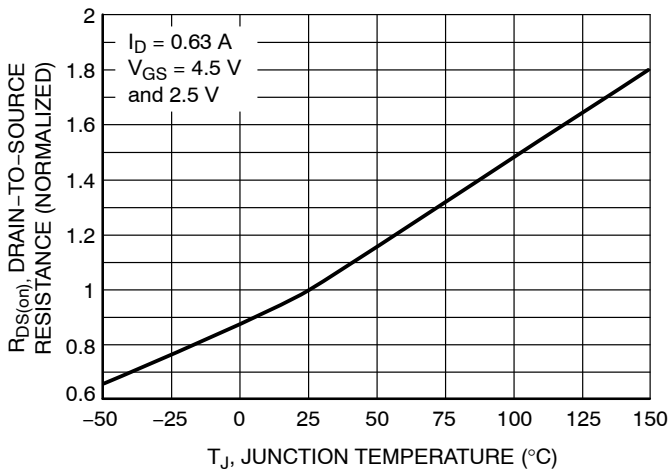

Figure 5. On-Resistance Variation with Temperature

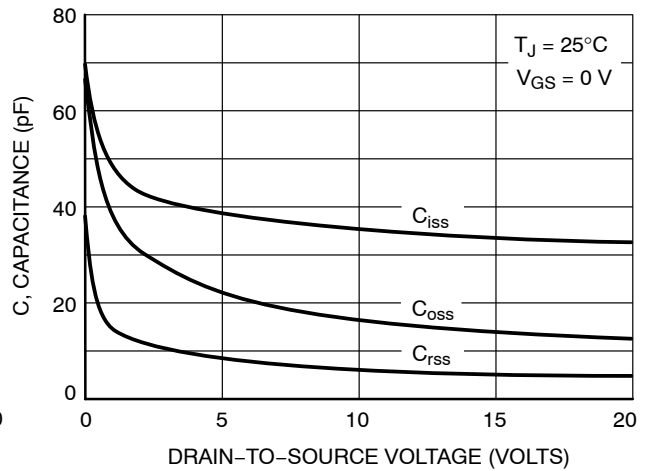

Figure 6. Capacitance Variation

NTJD4105C

TYPICAL N-CHANNEL PERFORMANCE CURVES ($T_J = 25^\circ\text{C}$ unless otherwise noted)

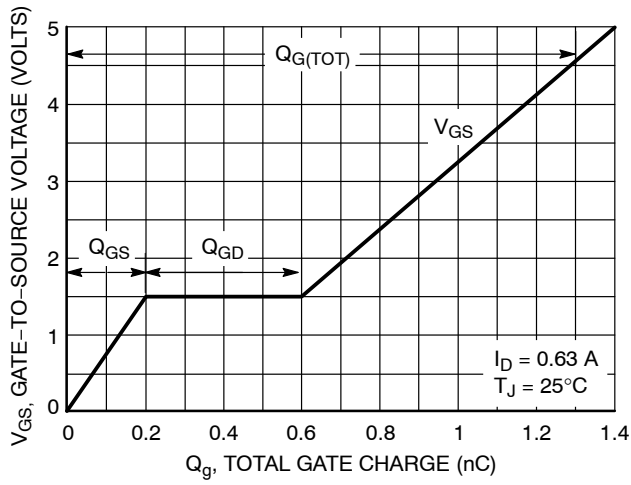

Figure 7. Gate-to-Source and Drain-to-Source Voltage vs. Total Charge

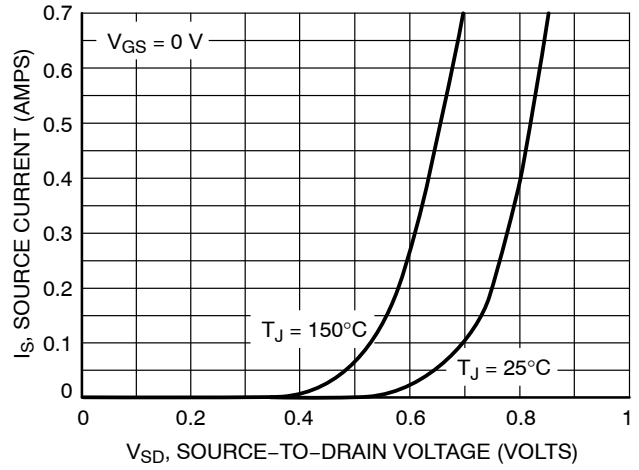

Figure 8. Diode Forward Voltage vs. Current

NTJD4105C

TYPICAL P-CHANNEL PERFORMANCE CURVES ($T_J = 25^\circ\text{C}$ unless otherwise noted)

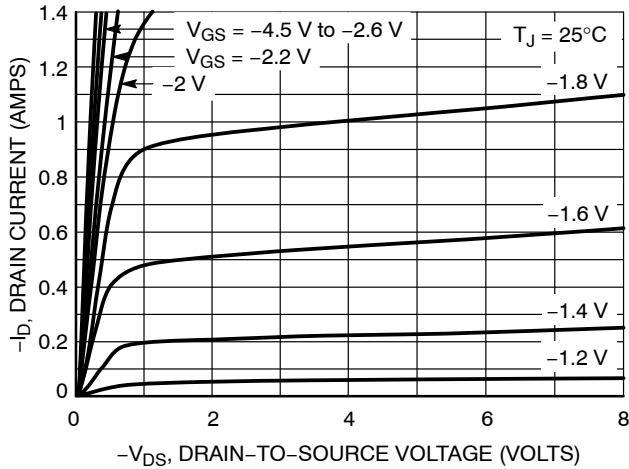

Figure 9. On-Region Characteristics

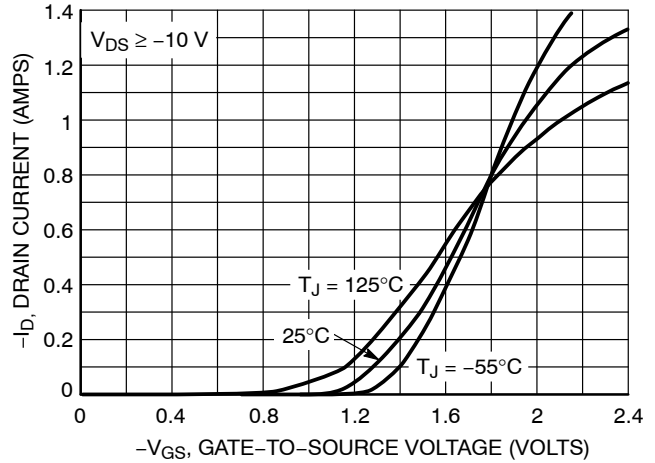

Figure 10. Transfer Characteristics

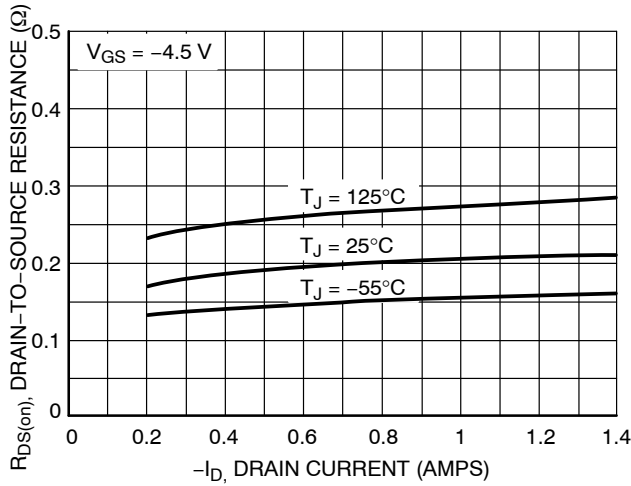

Figure 11. On-Resistance vs. Drain Current and Temperature

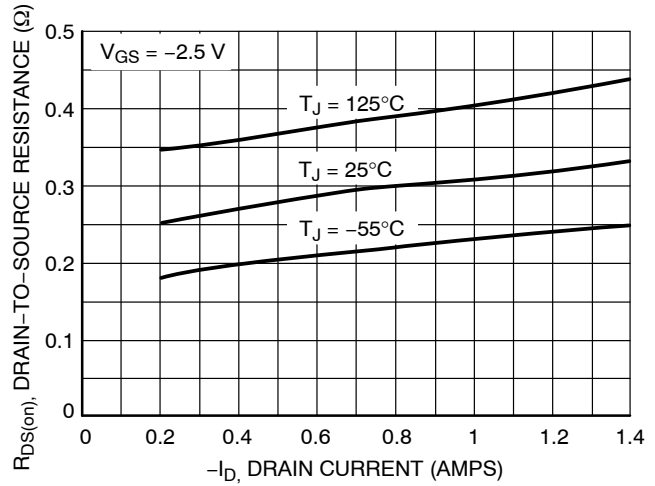

Figure 12. On-Resistance vs. Drain Current and Temperature

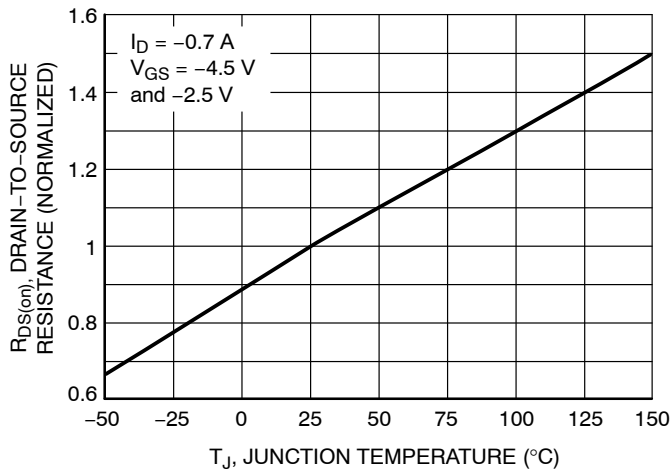

Figure 13. On-Resistance Variation with Temperature

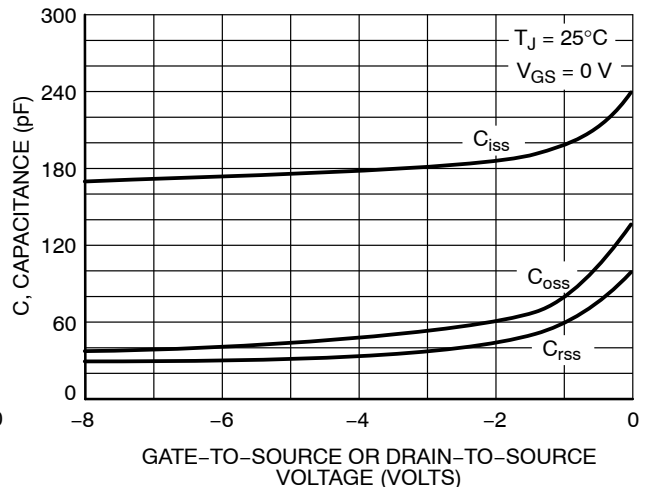

Figure 14. Capacitance Variation

NTJD4105C

TYPICAL P-CHANNEL PERFORMANCE CURVES ($T_J = 25^\circ\text{C}$ unless otherwise noted)

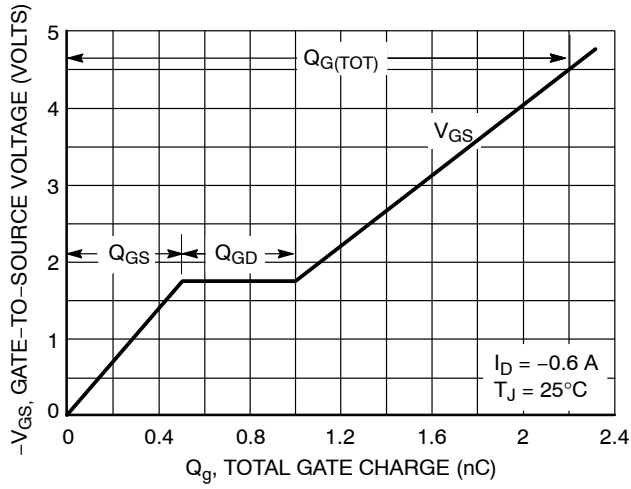

Figure 15. Gate-to-Source and Drain-to-Source Voltage vs. Total Charge

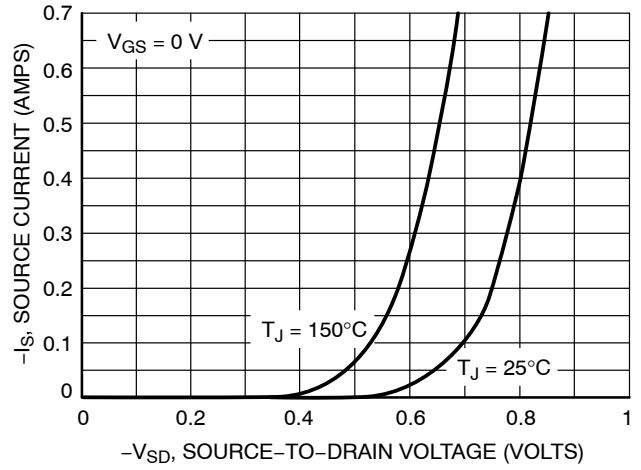

Figure 16. Diode Forward Voltage vs. Current

NTJD4105C

ORDERING INFORMATION

Device	Package	Shipping†
NTJD4105CT1	SOT-363	3000 / Tape & Reel
NTJD4105CT1G	SOT-363 (Pb-Free)	3000 / Tape & Reel
NTJD4105CT2	SOT-363	3000 / Tape & Reel
NTJD4105CT2G	SOT-363 (Pb-Free)	3000 / Tape & Reel
NTJD4105CT4	SOT-363	10,000 / Tape & Reel
NTJD4105CT4G	SOT-363 (Pb-Free)	10,000 / Tape & Reel

†For information on tape and reel specifications, including part orientation and tape sizes, please refer to our Tape and Reel Packaging Specifications Brochure, BRD8011/D.

MECHANICAL CASE OUTLINE PACKAGE DIMENSIONS



SC-88 2.00x1.25x0.90, 0.65P
CASE 419B-02
ISSUE Z

DATE 18 APR 2024

NOTES:

1. DIMENSIONING AND TOLERANCING CONFORM TO ASME Y14.5-2018.
2. ALL DIMENSION ARE IN MILLIMETERS.
3. DIMENSIONS D AND E1 DO NOT INCLUDE MOLD FLASH, PROTRUSIONS, OR GATE BURRS. MOLD FLASH, PROTRUSIONS, OR GATE BURRS SHALL NOT EXCEED 0.20 PER END.
4. DIMENSIONS D AND E1 AT THE OUTERMOST EXTREMES OF THE PLASTIC BODY AND DATUM H.
5. DATUMS A AND B ARE DETERMINED AT DATUM H.
6. DIMENSIONS b AND c APPLY TO THE FLAT SECTION OF THE LEAD BETWEEN 0.08 AND 0.15 FROM THE TIP.
7. DIMENSION b DOES NOT INCLUDE DAMBAR PROTRUSION. ALLOWABLE DAMBAR PROTRUSION SHALL BE 0.08 TOTAL IN EXCESS OF DIMENSION b AT MAXIMUM MATERIAL CONDITION. THE DAMBAR CANNOT BE LOCATED ON THE LOWER RADIUS OF THE FOOT.

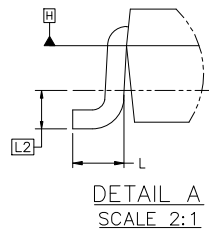

DIM	MILLIMETERS		
	MIN.	NOM.	MAX.
A	---	---	1.10
A1	0.00	---	0.10
A2	0.70	0.90	1.00
b	0.15	0.20	0.25
c	0.08	0.15	0.22
D	2.00 BSC		
E	2.10 BSC		
E1	1.25 BSC		
e	0.65 BSC		
L	0.26	0.36	0.46
L2	0.15 BSC		
aaa	0.15		
bbb	0.30		
ccc	0.10		
ddd	0.10		



GENERIC MARKING DIAGRAM*

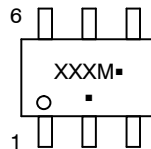

- XXX = Specific Device Code
- M = Date Code*
- = Pb-Free Package

(Note: Microdot may be in either location)

*Date Code orientation and/or position may vary depending upon manufacturing location.

*This information is generic. Please refer to device data sheet for actual part marking. Pb-Free indicator, "G" or microdot "▪", may or may not be present. Some products may not follow the Generic Marking.

FOR ADDITIONAL INFORMATION ON OUR Pb-FREE STRATEGY AND SOLDERING DETAILS, PLEASE DOWNLOAD THE ONSEMI SOLDERING AND MOUNTING TECHNIQUES REFERENCE MANUAL, SOLDERRM/D.

STYLES ON PAGE 2

DOCUMENT NUMBER:	98ASB42985B	Electronic versions are uncontrolled except when accessed directly from the Document Repository. Printed versions are uncontrolled except when stamped "CONTROLLED COPY" in red.
DESCRIPTION:	SC-88 2.00x1.25x0.90, 0.65P	PAGE 1 OF 2

onsemi and ONSEMI are trademarks of Semiconductor Components Industries, LLC dba onsemi or its subsidiaries in the United States and/or other countries. onsemi reserves the right to make changes without further notice to any products herein. onsemi makes no warranty, representation or guarantee regarding the suitability of its products for any particular purpose, nor does onsemi assume any liability arising out of the application or use of any product or circuit, and specifically disclaims any and all liability, including without limitation special, consequential or incidental damages. onsemi does not convey any license under its patent rights nor the rights of others.

SC-88 2.00x1.25x0.90, 0.65P
CASE 419B-02
ISSUE Z

DATE 18 APR 2024

STYLE 1: PIN 1. EMITTER 2 2. BASE 2 3. COLLECTOR 1 4. EMITTER 1 5. BASE 1 6. COLLECTOR 2	STYLE 2: CANCELLED	STYLE 3: CANCELLED	STYLE 4: PIN 1. CATHODE 2. CATHODE 3. COLLECTOR 4. EMITTER 5. BASE 6. ANODE	STYLE 5: PIN 1. ANODE 2. ANODE 3. COLLECTOR 4. EMITTER 5. BASE 6. CATHODE	STYLE 6: PIN 1. ANODE 2 2. N/C 3. CATHODE 1 4. ANODE 1 5. N/C 6. CATHODE 2
STYLE 7: PIN 1. SOURCE 2 2. DRAIN 2 3. GATE 1 4. SOURCE 1 5. DRAIN 1 6. GATE 2	STYLE 8: CANCELLED	STYLE 9: PIN 1. EMITTER 2 2. EMITTER 1 3. COLLECTOR 1 4. BASE 1 5. BASE 2 6. COLLECTOR 2	STYLE 10: PIN 1. SOURCE 2 2. SOURCE 1 3. GATE 1 4. DRAIN 1 5. DRAIN 2 6. GATE 2	STYLE 11: PIN 1. CATHODE 2 2. CATHODE 2 3. ANODE 1 4. CATHODE 1 5. CATHODE 1 6. ANODE 2	STYLE 12: PIN 1. ANODE 2 2. ANODE 2 3. CATHODE 1 4. ANODE 1 5. ANODE 1 6. CATHODE 2
STYLE 13: PIN 1. ANODE 2. N/C 3. COLLECTOR 4. EMITTER 5. BASE 6. CATHODE	STYLE 14: PIN 1. VREF 2. GND 3. GND 4. IOUT 5. VEN 6. VCC	STYLE 15: PIN 1. ANODE 1 2. ANODE 2 3. ANODE 3 4. CATHODE 3 5. CATHODE 2 6. CATHODE 1	STYLE 16: PIN 1. BASE 1 2. EMITTER 2 3. COLLECTOR 2 4. BASE 2 5. EMITTER 1 6. COLLECTOR 1	STYLE 17: PIN 1. BASE 1 2. EMITTER 1 3. COLLECTOR 2 4. BASE 2 5. EMITTER 2 6. COLLECTOR 1	STYLE 18: PIN 1. VIN1 2. VCC 3. VOUT2 4. VIN2 5. GND 6. VOUT1
STYLE 19: PIN 1. IOUT 2. GND 3. GND 4. V CC 5. V EN 6. V REF	STYLE 20: PIN 1. COLLECTOR 2. COLLECTOR 3. BASE 4. EMITTER 5. COLLECTOR 6. COLLECTOR	STYLE 21: PIN 1. ANODE 1 2. N/C 3. ANODE 2 4. CATHODE 2 5. N/C 6. CATHODE 1	STYLE 22: PIN 1. D1 (i) 2. GND 3. D2 (j) 4. D2 (c) 5. VBUS 6. D1 (c)	STYLE 23: PIN 1. Vn 2. CH1 3. Vp 4. N/C 5. CH2 6. N/C	STYLE 24: PIN 1. CATHODE 2. ANODE 3. CATHODE 4. CATHODE 5. CATHODE 6. CATHODE
STYLE 25: PIN 1. BASE 1 2. CATHODE 3. COLLECTOR 2 4. BASE 2 5. EMITTER 6. COLLECTOR 1	STYLE 26: PIN 1. SOURCE 1 2. GATE 1 3. DRAIN 2 4. SOURCE 2 5. GATE 2 6. DRAIN 1	STYLE 27: PIN 1. BASE 2 2. BASE 1 3. COLLECTOR 1 4. EMITTER 1 5. EMITTER 2 6. COLLECTOR 2	STYLE 28: PIN 1. DRAIN 2. DRAIN 3. GATE 4. SOURCE 5. DRAIN 6. DRAIN	STYLE 29: PIN 1. ANODE 2. ANODE 3. COLLECTOR 4. EMITTER 5. BASE/ANODE 6. CATHODE	STYLE 30: PIN 1. SOURCE 1 2. DRAIN 2 3. DRAIN 2 4. SOURCE 2 5. GATE 1 6. DRAIN 1

Note: Please refer to datasheet for style callout. If style type is not called out in the datasheet refer to the device datasheet pinout or pin assignment.

DOCUMENT NUMBER:	98ASB42985B	Electronic versions are uncontrolled except when accessed directly from the Document Repository. Printed versions are uncontrolled except when stamped "CONTROLLED COPY" in red.
DESCRIPTION:	SC-88 2.00x1.25x0.90, 0.65P	PAGE 2 OF 2

onsemi and **ONSEMI** are trademarks of Semiconductor Components Industries, LLC dba **onsemi** or its subsidiaries in the United States and/or other countries. **onsemi** reserves the right to make changes without further notice to any products herein. **onsemi** makes no warranty, representation or guarantee regarding the suitability of its products for any particular purpose, nor does **onsemi** assume any liability arising out of the application or use of any product or circuit, and specifically disclaims any and all liability, including without limitation special, consequential or incidental damages. **onsemi** does not convey any license under its patent rights nor the rights of others.

onsemi, **Onsemi**, and other names, marks, and brands are registered and/or common law trademarks of Semiconductor Components Industries, LLC dba "**onsemi**" or its affiliates and/or subsidiaries in the United States and/or other countries. **onsemi** owns the rights to a number of patents, trademarks, copyrights, trade secrets, and other intellectual property. A listing of **onsemi**'s product/patent coverage may be accessed at www.onsemi.com/site/pdf/Patent-Marking.pdf. **onsemi** reserves the right to make changes at any time to any products or information herein, without notice. The information herein is provided "as-is" and **onsemi** makes no warranty, representation or guarantee regarding the accuracy of the information, product features, availability, functionality, or suitability of its products for any particular purpose, nor does **onsemi** assume any liability arising out of the application or use of any product or circuit, and specifically disclaims any and all liability, including without limitation special, consequential or incidental damages. Buyer is responsible for its products and applications using **onsemi** products, including compliance with all laws, regulations and safety requirements or standards, regardless of any support or applications information provided by **onsemi**. "Typical" parameters which may be provided in **onsemi** data sheets and/or specifications can and do vary in different applications and actual performance may vary over time. All operating parameters, including "Typicals" must be validated for each customer application by customer's technical experts. **onsemi** does not convey any license under any of its intellectual property rights nor the rights of others. **onsemi** products are not designed, intended, or authorized for use as a critical component in life support systems or any FDA Class 3 medical devices or medical devices with a same or similar classification in a foreign jurisdiction or any devices intended for implantation in the human body. Should Buyer purchase or use **onsemi** products for any such unintended or unauthorized application, Buyer shall indemnify and hold **onsemi** and its officers, employees, subsidiaries, affiliates, and distributors harmless against all claims, costs, damages, and expenses, and reasonable attorney fees arising out of, directly or indirectly, any claim of personal injury or death associated with such unintended or unauthorized use, even if such claim alleges that **onsemi** was negligent regarding the design or manufacture of the part. **onsemi** is an Equal Opportunity/Affirmative Action Employer. This literature is subject to all applicable copyright laws and is not for resale in any manner.

ADDITIONAL INFORMATION

TECHNICAL PUBLICATIONS:

Technical Library: www.onsemi.com/design/resources/technical-documentation
onsemi Website: www.onsemi.com

ONLINE SUPPORT: www.onsemi.com/support

For additional information, please contact your local Sales Representative at www.onsemi.com/support/sales



Looking for pricing, stock, or lifecycle information?

Click below to explore more details on WIN SOURCE:

 [View NTJD4105CT1G on WIN SOURCE](#)

 [ON Semiconductor](#) Information

Optimize Your Supply Chain with WIN SOURCE Solutions

-  Global Sourcing Solution
-  Obsolete Management
-  Cost Control Management
-  Shortage Management
-  Alternative Solution
-  Excess Inventory Management