



**THE DATASHEET OF
NUF2441FCT1G**



NUF2441FC

Integrated Passive Filter with ESD Protection

This device is designed for cell phone applications requiring **Headset and Speaker Phone, EMI Filtering and ESD Protection**. This device offers an integrated solution in a small package reducing PCB space and cost.

Features:

- Provides EMI Filtering and ESD Protection
- Single IC Offers Cost Savings by Replacing 2 Inductors, 4 Capacitors, and 4 TVs Diodes
- Compliance with IEC61000-4-2, (Level 4) 30 kV (Contact), 30 kV (air)
- Flip-Chip Package
- Moisture Sensitivity Level 1
- ESD Ratings: Machine Model = C
Human Body Model = 3B
- Pb-Free Package is Available*

Benefits:

- Flip-Chip Package Minimizes PCB Space
- Integrated Circuit Increases System Reliability versus Discrete Component Implementation
- TVs Devices Provide ESD Protection That is Better than a Discrete Implementation because the Small IC minimizes Parasitic Inductances

Typical Applications:

- Cell Phones
- Communication Circuits

MAXIMUM RATINGS (T_A = 25°C)

Rating	Symbol	Value	Unit
ESD Discharge IEC61000-4-2 Contact Discharge Air Discharge	V _{pp}	30 30	kV
Operating Temperature Range	T _J	-40 to +125	°C
Storage Temperature Range	T _{stg}	-55 to +150	°C
Lead Solder Temperature (10 second duration)	T _L	260	°C

Stresses exceeding Maximum Ratings may damage the device. Maximum Ratings are stress ratings only. Functional operation above the Recommended Operating Conditions is not implied. Extended exposure to stresses above the Recommended Operating Conditions may affect device reliability.

*For additional information on our Pb-Free strategy and soldering details, please download the ON Semiconductor Soldering and Mounting Techniques Reference Manual, SOLDERRM/D.



ON Semiconductor[®]

<http://onsemi.com>

CIRCUIT DESCRIPTION

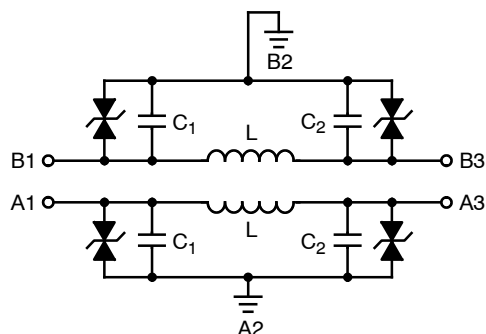

MARKING DIAGRAM



Flip-Chip
CASE 499J

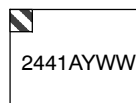

2441 = Specific Device Code
A = Assembly Location
Y = Year
WW = Work Week

PIN CONFIGURATION

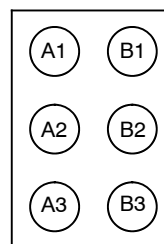

(Bump View)

ORDERING INFORMATION

Package	Device	Shipping [†]
NUF2441FCT1	Flip-Chip	3000/Tape & Reel
NUF2441FCT1G	Flip-Chip (Pb-Free)	3000/Tape & Reel

[†]For information on tape and reel specifications, including part orientation and tape sizes, please refer to our Tape and Reel Packaging Specification Brochure, BRD8011/D.

NUF2441FC

ELECTRICAL CHARACTERISTICS ($T_A = 25^\circ\text{C}$)

Device	Device Marking	V_{RWM} (Volts)	V_{BR} @ 1 mA (Volts)		Max I_R @ $V_{RWM} = 12\text{ V}$ I/O Pin (μA)	Typical Capacitance $C_1 + C_2$ (pF) (Notes 1, 3, 4)	Typical Pass-Band Inductance L (nH)	Equivalent Series Resistance R_S (Ω) (Note 2)	
			Min	Max				Typ	Max
NUF2441FCT1G	2441	12	13.7	17.7	0.1	250	2.9	0.28	0.35

1. Measured at 25°C , $V_R = 0$, $f = 1\text{ MHz}$, Source A1, GND A2, Open A3.
2. Measured at room temperature.
3. Tolerance = $\pm 20\%$.
4. Measured under zero light conditions.

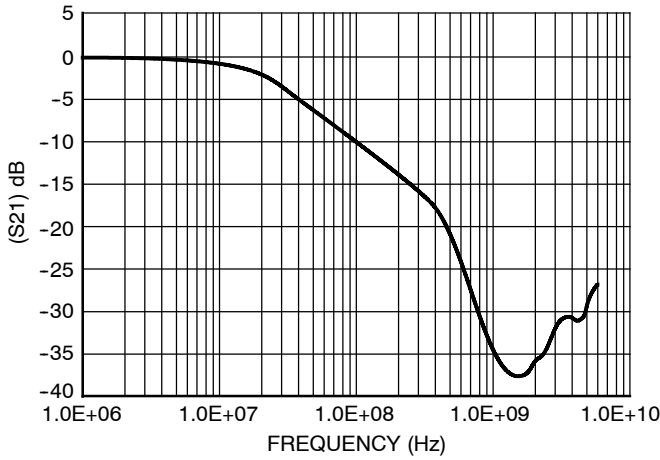

Figure 1. Insertion Loss Characteristic

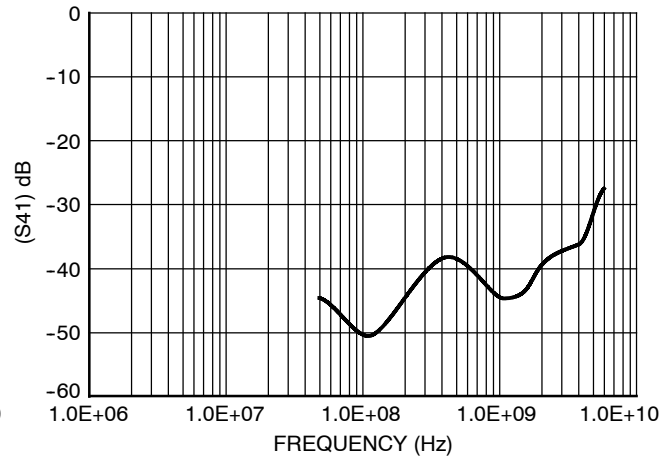

Figure 2. Analog Crosstalk

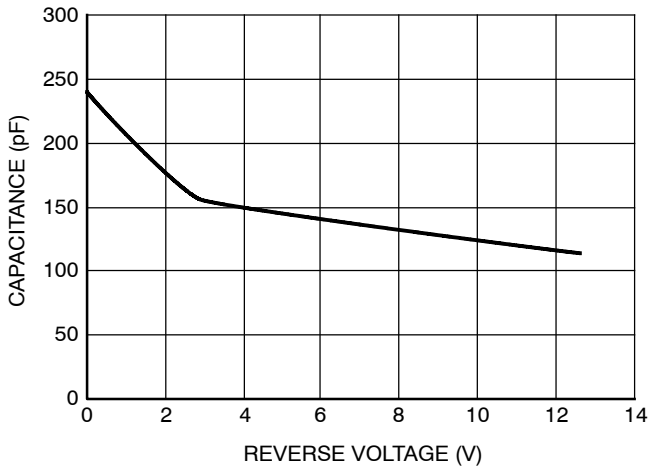

Figure 3. Typical Line Capacitance vs. Reverse Bias Voltage

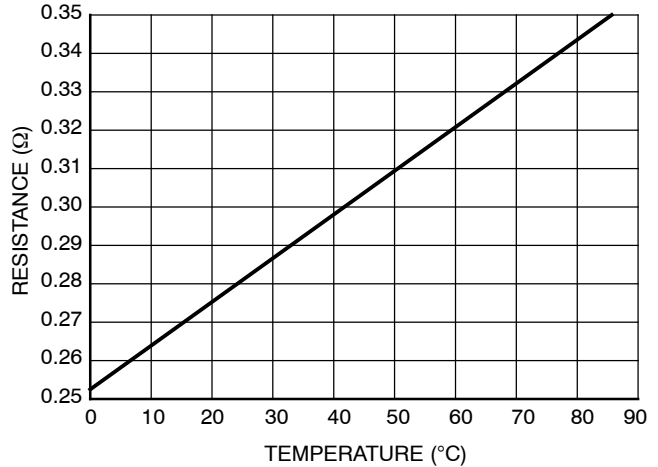
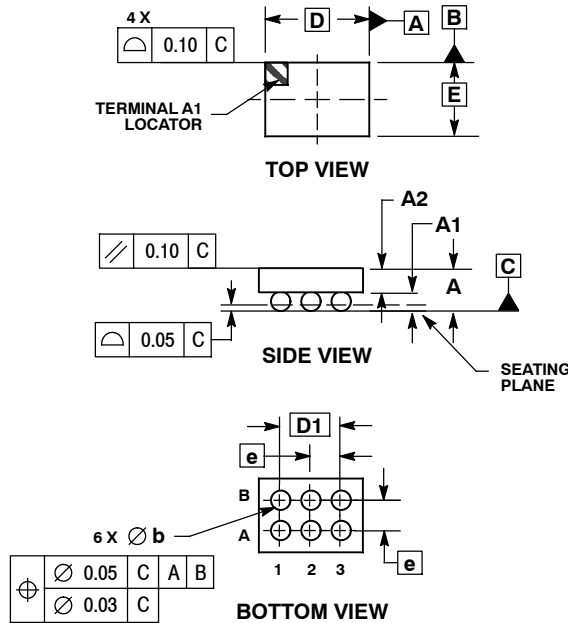

Figure 4. Typical Resistance vs. Temperature

NUF2441FC

PACKAGE DIMENSIONS

6 PIN FLIP-CHIP CSP CASE 499J-01 ISSUE O



NOTES:

1. DIMENSIONING AND TOLERANCING PER ASME Y14.5M, 1994.
2. CONTROLLING DIMENSION: MILLIMETERS.
3. COPLANARITY APPLIES TO SPHERICAL CROWNS OF SOLDER BALLS.

DIM	MILLIMETERS	
	MIN	MAX
A	---	0.700
A1	0.210	0.270
A2	0.380	0.430
D	1.720 BSC	
E	1.220 BSC	
b	0.290	0.340
e	0.500 BSC	
D1	1.000 BSC	

ON Semiconductor and are registered trademarks of Semiconductor Components Industries, LLC (SCILLC). SCILLC reserves the right to make changes without further notice to any products herein. SCILLC makes no warranty, representation or guarantee regarding the suitability of its products for any particular purpose, nor does SCILLC assume any liability arising out of the application or use of any product or circuit, and specifically disclaims any and all liability, including without limitation special, consequential or incidental damages. "Typical" parameters which may be provided in SCILLC data sheets and/or specifications can and do vary in different applications and actual performance may vary over time. All operating parameters, including "Typicals" must be validated for each customer application by customer's technical experts. SCILLC does not convey any license under its patent rights nor the rights of others. SCILLC products are not designed, intended, or authorized for use as components in systems intended for surgical implant into the body, or other applications intended to support or sustain life, or for any other application in which the failure of the SCILLC product could create a situation where personal injury or death may occur. Should Buyer purchase or use SCILLC products for any such unintended or unauthorized application, Buyer shall indemnify and hold SCILLC and its officers, employees, subsidiaries, affiliates, and distributors harmless against all claims, costs, damages, and expenses, and reasonable attorney fees arising out of, directly or indirectly, any claim of personal injury or death associated with such unintended or unauthorized use, even if such claim alleges that SCILLC was negligent regarding the design or manufacture of the part. SCILLC is an Equal Opportunity/Affirmative Action Employer. This literature is subject to all applicable copyright laws and is not for resale in any manner.

PUBLICATION ORDERING INFORMATION

LITERATURE FULFILLMENT:

Literature Distribution Center for ON Semiconductor
P.O. Box 5163, Denver, Colorado 80217 USA
Phone: 303-675-2175 or 800-344-3860 Toll Free USA/Canada
Fax: 303-675-2176 or 800-344-3867 Toll Free USA/Canada
Email: orderlit@onsemi.com

N. American Technical Support: 800-282-9855 Toll Free
USA/Canada
Europe, Middle East and Africa Technical Support:
Phone: 421 33 790 2910
Japan Customer Focus Center
Phone: 81-3-5773-3850

ON Semiconductor Website: www.onsemi.com

Order Literature: <http://www.onsemi.com/orderlit>

For additional information, please contact your local Sales Representative

Looking for pricing, stock, or lifecycle information?

Click below to explore more details on WIN SOURCE:

 [View NUF2441FCT1G on WIN SOURCE](#)

 [ON Semiconductor](#) Information

Optimize Your Supply Chain with WIN SOURCE Solutions

-  Global Sourcing Solution
-  Obsolete Management
-  Cost Control Management
-  Shortage Management
-  Alternative Solution
-  Excess Inventory Management