



THE DATASHEET OF OPA137U





OPA137
OPA2137
OPA4137

LOW COST FET-INPUT OPERATIONAL AMPLIFIERS *MicroAmplifier™ Series*

FEATURES

- **FET INPUT:** $I_B = 5\text{pA}$
- **LOW OFFSET VOLTAGE:** 1.5mV
- **WIDE SUPPLY RANGE:** $\pm 2.25\text{V}$ to $\pm 18\text{V}$
- **LOW QUIESCENT CURRENT:** 220 μA /channel
- **EXCELLENT SPEED/POWER:** 1MHz
- **INPUT TO POSITIVE SUPPLY**
- **MicroSIZE PACKAGES:** SOT-23-5, MSOP-8
- **SINGLE, DUAL, AND QUAD**

APPLICATIONS

- **STRAIN GAGE AMPLIFIER**
- **PHOTODETECTOR AMPLIFIER**
- **PRECISION INTEGRATOR**
- **BATTERY-POWERED INSTRUMENTS**
- **TEST EQUIPMENT**
- **ACTIVE FILTERS**

DESCRIPTION

OPA137 series FET-input operational amplifiers are designed for low cost and miniature applications. In addition to small size (SOT-23-5 and MSOP-8 packages), they provide low input bias current (5pA), low quiescent current (220 μA /channel), and high open-loop gain (94dB).

Either single (+4.5V to +36V) or dual (± 2.25 to $\pm 18\text{V}$) supplies can be used. The input common-mode voltage range includes the positive supply—suitable for many single-supply applications. Single, dual, and quad versions have identical specifications for maximum design flexibility.

OPA137 op amps are easy to use and free from phase inversion and overload problems found in some FET-input amplifiers. High performance, including linearity, is maintained as the amplifiers swing to their specified limits. In addition, the combination of high slew rate (3.5V/ μs) and wide bandwidth (1MHz) provide fast settling time assuring good dynamic response. Dual and quad designs feature completely independent circuitry for lowest crosstalk and freedom from interaction.

The single (OPA137) packages are the tiny 5-lead SOT-23-5 surface mount, SO-8 surface mount, and 8-pin DIP. The dual (OPA2137) comes in the miniature MSOP-8 surface mount, SO-8 surface mount, and 8-pin DIP packages. The quad (OPA4137) packages are the SO-14 surface mount and the 14-pin DIP. All are specified from -40°C to $+85^\circ\text{C}$ and operate from -55°C to $+125^\circ\text{C}$. A SPICE macromodel is available for design analysis.



International Airport Industrial Park • Mailing Address: PO Box 11400, Tucson, AZ 85734 • Street Address: 6730 S. Tucson Blvd., Tucson, AZ 85706 • Tel: (520) 746-1111 • Twx: 910-952-1111
 Internet: <http://www.burr-brown.com/> • FAXLine: (800) 548-6133 (US/Canada Only) • Cable: BBRCORP • Telex: 066-6491 • FAX: (520) 889-1510 • Immediate Product Info: (800) 548-6132

SPECIFICATIONS: $V_S = \pm 15V$

At $T_A = +25^\circ C$, $R_L = 10k\Omega$ connected to ground, unless otherwise noted.

Boldface limits apply over the specified temperature range, $T_A = -40^\circ C$ to $+85^\circ C$.

PARAMETER	CONDITION	OPA137N, U, P OPA2137E, U, P OPA4137U, P			OPA137NA, UA, PA OPA2137EA, UA, PA OPA4137UA, PA			UNITS
		MIN	TYP	MAX	MIN	TYP	MAX	
OFFSET VOLTAGE Input Offset Voltage V_{OS} $T_A = -40^\circ C$ to $+85^\circ C$ vs Temperature dV_{OS}/dT vs Power Supply PSRR $T_A = -40^\circ C$ to $+85^\circ C$ Channel Separation (dual, quad)	$T_A = -40^\circ C$ to $+85^\circ C$ $V_S = \pm 3V$ to $\pm 18V$ dc		± 1.5 ± 2.5 ± 15 ± 90 0.6	± 3 ± 7 ± 250 ± 250		± 2.5 ± 3.5 * * *	± 10 ± 15 * * *	mV mV $\mu V/^\circ C$ $\mu V/V$ $\mu V/V$
INPUT BIAS CURRENT Input Bias Current I_B vs Temperature Input Offset Current I_{OS}	$V_{CM} = 0V$		See Typical Curve ± 5 ± 2	± 100 ± 50		* * *	* * *	pA pA
NOISE Input Voltage Noise, $f = 0.1$ to $10kHz$ Input Voltage Noise Density, $f = 1kHz$ e_n Current Noise Density, $f = 1kHz$ i_n			2 45 1.2			* * *		$\mu Vp-p$ nV/\sqrt{Hz} fA/\sqrt{Hz}
INPUT VOLTAGE RANGE Common-Mode Voltage Range V_{CM} Common-Mode Rejection Ratio CMRR OPA137, OPA2137 OPA4137 $T_A = -40^\circ C$ to $+85^\circ C$ OPA137, OPA2137 OPA4137	$V_{CM} = -12V$ to $15V$ $V_{CM} = -12V$ to $15V$	$(V-) + 3$ 76 74 72 70	84 84	$(V+)$ 	* 70 70 70 70	* * * *	* 	V dB dB dB
INPUT IMPEDANCE Differential Common-Mode			$10^{10} \parallel 1$ $10^{12} \parallel 2$			* *		$\Omega \parallel pF$ $\Omega \parallel pF$
OPEN-LOOP GAIN Open-Loop Voltage Gain A_{OL} $T_A = -40^\circ C$ to $+85^\circ C$	$V_O = -13.8V$ to $13.9V$ $V_O = -13.8V$ to $13.9V$	86 86	94		* *	* *		dB dB
FREQUENCY RESPONSE Gain-Bandwidth Product GBW Slew Rate SR Settling Time, 0.1% 0.01% Overload Recovery Time Total Harmonic Distortion + Noise THD+N	$G = 1$ $G = 1, 10V$ Step, $C_L = 100pF$ $G = 1, 10V$ Step, $C_L = 100pF$ $V_{IN} * G = V_S$ $G = 1, f = 1kHz, 3.5V_{rms}$		1 3.5 8 10 1 0.05			* * * * * *		MHz $V/\mu s$ μs μs μs %
OUTPUT Voltage Output V_{OUT} $T_A = -40^\circ C$ to $+85^\circ C$ Short-Circuit Current I_{SC} Capacitive Load Drive C_{LOAD}		$(V-) + 1.2$ $(V-) + 1.2$	$-25/+60$ 1000	$(V+) - 1.1$ $(V+) - 1.1$	* *	* *	* *	V V mA pF
POWER SUPPLY Specified Operating Range V_S Operating Voltage Range Dual Supplies Single Supply Quiescent Current I_Q $T_A = -40^\circ C$ to $+85^\circ C$	$I_O = 0$ $I_O = 0$	$\pm 2.25^{(1)}$ +4.5	± 15 ± 220	± 18 +36 ± 270 ± 375	* *	* *	* * * *	V V V μA μA
TEMPERATURE RANGE Specified Range Operating Range Storage Range Thermal Resistance θ_{JA} SOT-23-5 Surface Mount MSOP-8 Surface Mount SO-8 Surface Mount 8-Pin DIP SO-14 Surface Mount 14-Pin DIP		-40 -55 -55		+85 +125 +125	* * *		* * *	$^\circ C$ $^\circ C$ $^\circ C$ $^\circ C/W$ $^\circ C/W$ $^\circ C/W$ $^\circ C/W$ $^\circ C/W$ $^\circ C/W$

* Specifications the same as OPA137N, U, P.

NOTE: (1) At minimum power supply voltage inputs must be biased above ground in accordance with common-mode voltage range restrictions—see “Operating Voltage” discussion.

ABSOLUTE MAXIMUM RATINGS⁽¹⁾

Supply Voltage, V+ to V-	36V
Input Voltage	(V-) -0.7V to (V+) +0.7V
Input Current	2mA
Output Short-Circuit ⁽²⁾	Continuous
Operating Temperature	-55°C to +125°C
Storage Temperature	-55°C to +125°C
Junction Temperature	+150°C
Lead Temperature (soldering, 10s)	300°C

NOTE: (1) Stresses above these ratings may cause permanent damage. Exposure to absolute maximum ratings for extended periods may affect device reliability. (2) Short circuit to ground, one amplifier per package.



ELECTROSTATIC DISCHARGE SENSITIVITY

This integrated circuit can be damaged by ESD. Burr-Brown recommends that all integrated circuits be handled with appropriate precautions. Failure to observe proper handling and installation procedures can cause damage.

ESD damage can range from subtle performance degradation to complete device failure. Precision integrated circuits may be more susceptible to damage because very small parametric changes could cause the device not to meet its published specifications.

PACKAGE/ORDERING INFORMATION

PRODUCT	PACKAGE	PACKAGE DRAWING NUMBER ⁽¹⁾	SPECIFIED TEMPERATURE RANGE	PACKAGE MARKING	ORDERING NUMBER ⁽²⁾	TRANSPORT MEDIA
Single						
OPA137N	5-Lead SOT-23-5 Surface Mount	331	-40°C to +85°C	E37 ⁽³⁾	OPA137N/250	Tape and Reel
"	"	"	"	"	OPA137N/3K	Tape and Reel
OPA137NA	5-Lead SOT-23-5 Surface Mount	331	-40°C to +85°C	E37 ⁽³⁾	OPA137NA/250	Tape and Reel
"	"	"	"	"	OPA137NA/3K	Tape and Reel
OPA137U	SO-8 Surface Mount	182	-40°C to +85°C	OPA137U	OPA137U	Rails
"	"	"	"	"	OPA137U/2K5	Tape and Reel
OPA137UA	SO-8 Surface Mount	182	-40°C to +85°C	OPA137UA	OPA137UA	Rails
"	"	"	"	"	OPA137UA/2K5	Tape and Reel
OPA137P	8-Pin DIP	006	-40°C to +85°C	OPA137P	OPA137P	Rails
OPA137PA	8-Pin DIP	006	-40°C to +85°C	OPA137PA	OPA137PA	Rails
Dual						
OPA2137E	MSOP-8 Surface Mount	337	-40°C to +85°C	E37 ⁽³⁾	OPA2137E/250	Tape and Reel
"	"	"	"	"	OPA2137E/2K5	Tape and Reel
OPA2137EA	MSOP-8 Surface Mount	337	-40°C to +85°C	E37 ⁽³⁾	OPA2137EA/250	Tape and Reel
"	"	"	"	"	OPA2137EA/2K5	Tape and Reel
OPA2137U	SO-8 Surface Mount	182	-40°C to +85°C	OPA2137U	OPA2137U	Rails
"	"	"	"	"	OPA2137U/2K5	Tape and Reel
OPA2137UA	SO-8 Surface Mount	182	-40°C to +85°C	OPA2137UA	OPA2137UA	Rails
"	"	"	"	"	OPA2137UA/2K5	Tape and Reel
OPA2137P	8-Pin DIP	006	-40°C to +85°C	OPA2137P	OPA2137P	Rails
OPA2137PA	8-Pin DIP	006	-40°C to +85°C	OPA2137PA	OPA2137PA	Rails
Quad						
OPA4137U	SO-14 Surface Mount	235	-40°C to +85°C	OPA4137U	OPA4137U	Rails
"	"	"	"	"	OPA4137U/2K5	Tape and Reel
OPA4137UA	SO-14 Surface Mount	235	-40°C to +85°C	OPA4137UA	OPA4137UA	Rails
"	"	"	"	"	OPA4137UA/2K5	Tape and Reel
OPA4137P	14-Pin DIP	010	-40°C to +85°C	OPA4137P	OPA4137P	Rails
OPA4137PA	14-Pin DIP	010	-40°C to +85°C	OPA4137PA	OPA4137PA	Rails

NOTES: (1) For detailed drawing and dimension table, please see end of data sheet, or Appendix C of Burr-Brown IC Data Book. (2) Models with a slash (/) are available only in Tape and Reel in the quantities indicated (e.g., /2K5 indicates 2500 devices per reel). Ordering 3000 pieces of "OPA137NA/3K" will get a single 3000-piece Tape and Reel. For detailed Tape and Reel mechanical information, refer to Appendix B of Burr-Brown IC Data Book. (3) Grade information is marked on the reel.

The information provided herein is believed to be reliable; however, BURR-BROWN assumes no responsibility for inaccuracies or omissions. BURR-BROWN assumes no responsibility for the use of this information, and all use of such information shall be entirely at the user's own risk. Prices and specifications are subject to change without notice. No patent rights or licenses to any of the circuits described herein are implied or granted to any third party. BURR-BROWN does not authorize or warrant any BURR-BROWN product for use in life support devices and/or systems.

TYPICAL PERFORMANCE CURVES

At $T_A = +25^\circ\text{C}$, $V_S = \pm 15\text{V}$, $R_L = 10\text{k}\Omega$, connected to ground, unless otherwise noted.

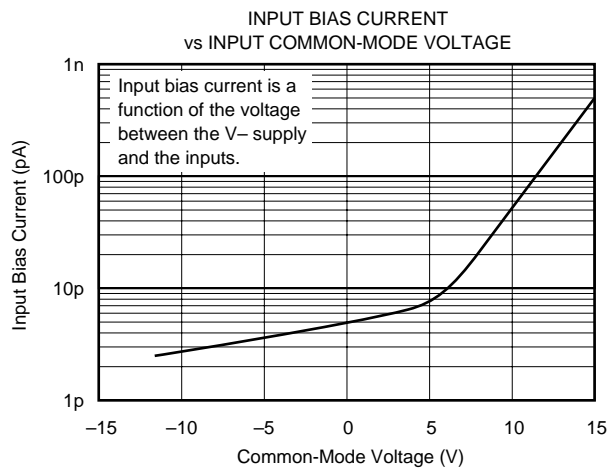
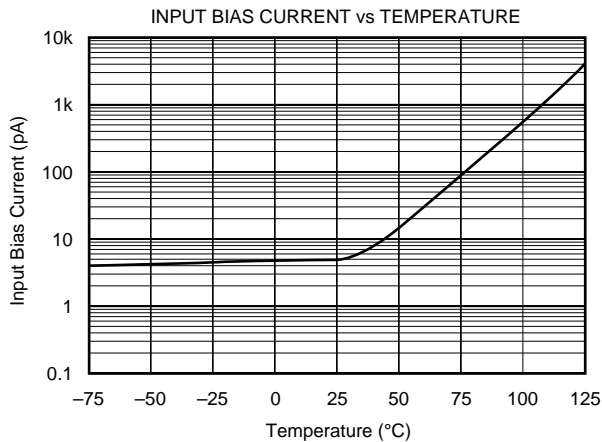
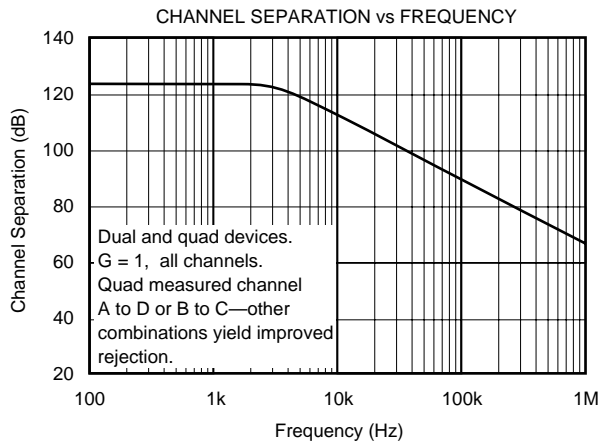
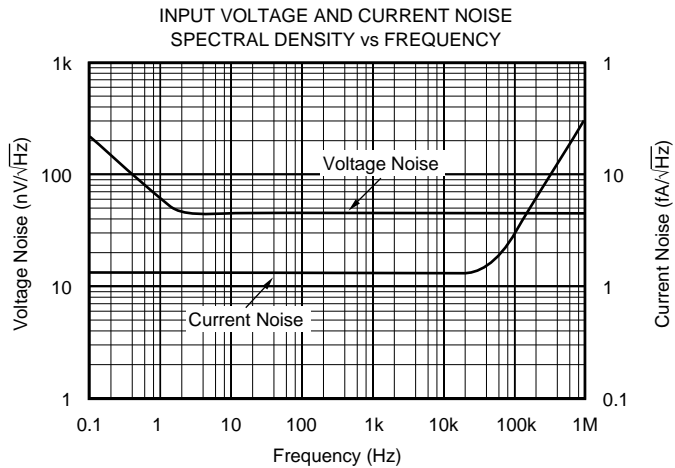
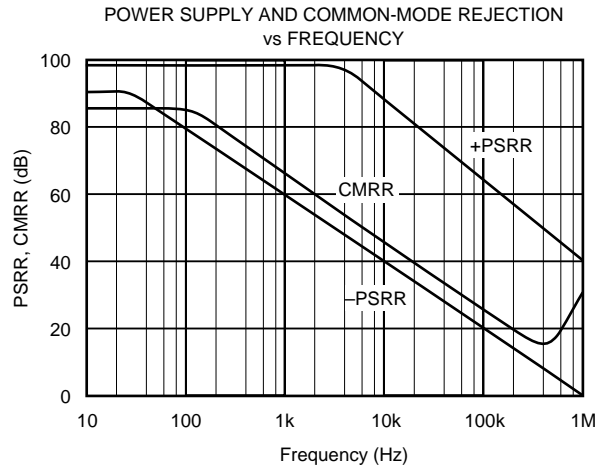

TYPICAL PERFORMANCE CURVES (CONT)

At $T_A = +25^\circ\text{C}$, $V_S = \pm 15\text{V}$, $R_L = 10\text{k}\Omega$, connected to ground, unless otherwise noted.

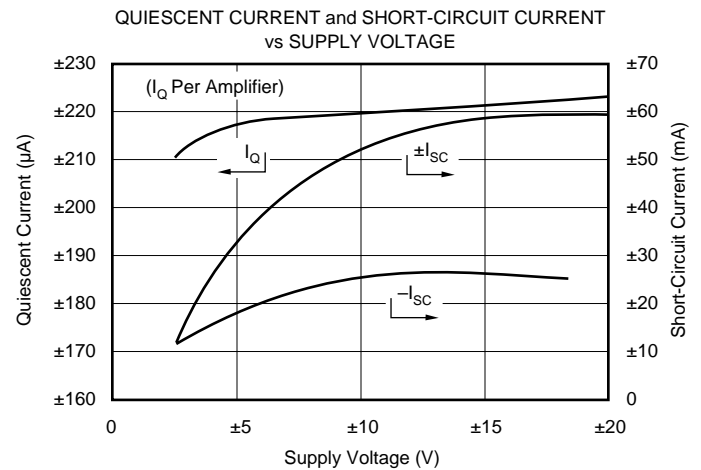
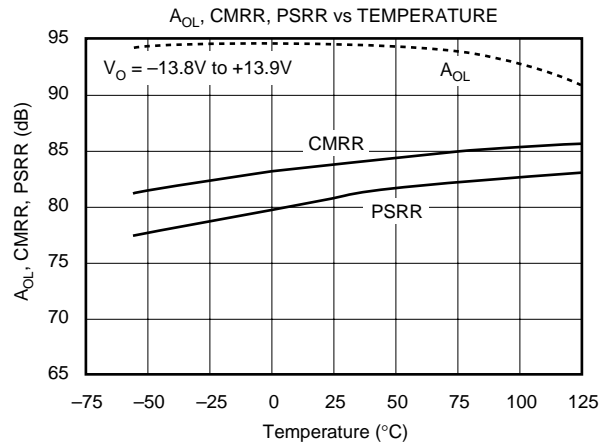
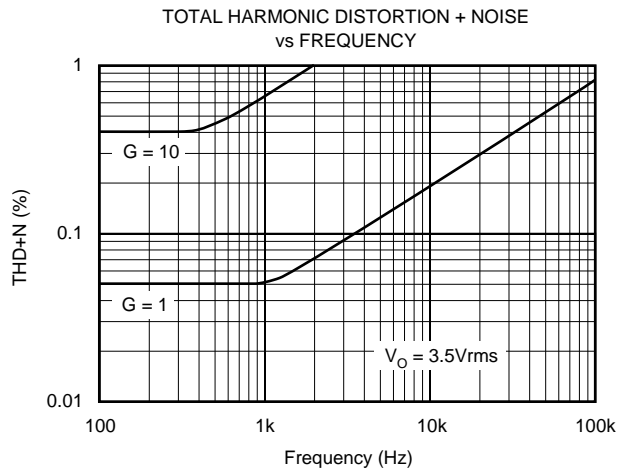

TYPICAL PERFORMANCE CURVES (CONT)

At $T_A = +25^\circ\text{C}$, $V_S = \pm 15\text{V}$, $R_L = 10\text{k}\Omega$, connected to ground, unless otherwise noted.

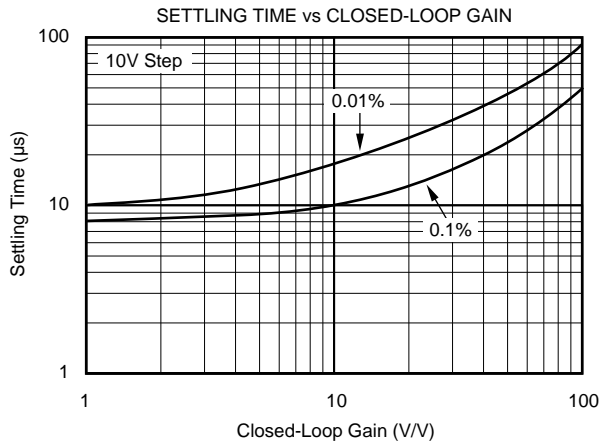

APPLICATIONS INFORMATION

OPA137 series op amps are unity-gain stable and suitable for a wide range of general-purpose applications. Power supply pins should be bypassed with 10nF ceramic capacitors or larger. All circuitry is completely independent in dual and quad versions, assuring normal performance when one amplifier in a package is overdriven or short circuited. Many key parameters are guaranteed over the specified temperature range, -40°C to $+85^{\circ}\text{C}$.

OPERATING VOLTAGE

OPA137 op amps can be operated on power supplies as low as $\pm 2.25\text{V}$. Performance remains excellent with power supplies ranging from $\pm 2.25\text{V}$ to $\pm 18\text{V}$ ($+4.5\text{V}$ to $+36\text{V}$ single supply). Most parameters vary only slightly throughout this supply voltage range. Quiescent current and short-circuit current vs supply voltage are shown in Typical Performance Curves.

Operation at very low supply voltage ($V_S \leq \pm 3\text{V}$) requires careful attention to ensure that the common-mode voltage remains within the linear range, $V_{CM} = (V-) + 3\text{V}$ to $(V+)$. Inputs may need to be biased above ground in accordance with the common-mode voltage range restrictions for linear operation.

INPUT VOLTAGE

The input common-mode voltage range of OPA137 series op amps extends from $(V-) + 3\text{V}$ to the positive rail, $V+$. For normal operation, inputs should be limited to this range. The inputs may go beyond the power supplies without output phase-reversal. Many FET-input op amps (such as TL061 types) exhibit phase-reversal of the output when the input common-mode range is exceeded. This can occur in voltage-follower circuits, causing serious problems in control loop applications.

Input terminals are diode-clamped to the power supply rails for ESD protection. If the input voltage can exceed the negative supply by 500mV, input current should be limited to 2mA (or less). If the input current is not adequately limited, you may see unpredictable behavior in the other amplifiers in the package. This is easily accomplished with an input resistor as shown in Figure 1. Many input signals are inherently current-limited, therefore, a limiting resistor may not be required.

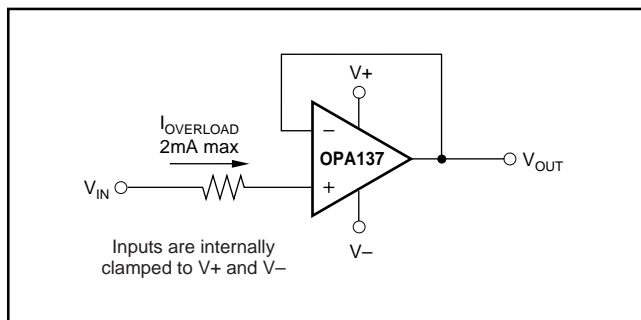

FIGURE 1. Input Current Protection for Voltages Exceeding the Supply Voltage.

HIGH-SIDE CURRENT SENSING

Many applications require the sensing of signals near the positive supply. The common-mode input range of OPA137 op amps includes the positive rail, enabling them to be used to sense power supply currents as shown in Figure 2.



FIGURE 2. High-Side Current Monitor.

INPUT BIAS CURRENT

The input bias current is approximately 5pA at room temperature and increases with temperature as shown in the typical performance curve “Input Bias Current vs Temperature.”

Input Bias current also varies with common-mode voltage and power supply voltage. This variation is dependent on the voltage between the negative power supply and the common-mode input voltage. The effect is shown in the typical performance curve “Input Bias Current vs Common-Mode Voltage.”



FIGURE 3. Photodetector Amplifier.

SOT-23-5
(Package Drawing #331)

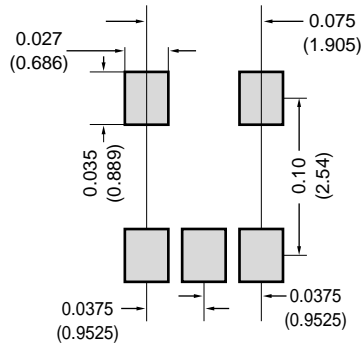

MSOP-8
(Package Drawing #337)



Refer to end of data sheet or Appendix C of Burr-Brown Data Book for tolerances and detailed package drawing. For further information on solder pads for surface-mount devices consult Application Bulletin AB-132.

FIGURE 4. Recommended SOT-23-5 and MSOP-8 Solder Footprints.

PACKAGING INFORMATION

Orderable Device	Status (1)	Package Type	Package Drawing	Pins	Package Qty	Eco Plan (2)	Lead/Ball Finish (6)	MSL Peak Temp (3)	Op Temp (°C)	Device Marking (4/5)	Samples
OPA137N/250	ACTIVE	SOT-23	DBV	5	250	Green (RoHS & no Sb/Br)	CU NIPDAU	Level-2-260C-1 YEAR	-40 to 85	E37	Samples
OPA137N/3K	ACTIVE	SOT-23	DBV	5	3000	Green (RoHS & no Sb/Br)	CU NIPDAU	Level-2-260C-1 YEAR	-40 to 85	E37	Samples
OPA137N/3KE4	ACTIVE	SOT-23	DBV	5	3000	Green (RoHS & no Sb/Br)	CU NIPDAU	Level-2-260C-1 YEAR	-40 to 85	E37	Samples
OPA137NA/250	ACTIVE	SOT-23	DBV	5	250	Green (RoHS & no Sb/Br)	CU NIPDAU	Level-2-260C-1 YEAR	-40 to 85	E37	Samples
OPA137NA/250E4	ACTIVE	SOT-23	DBV	5	250	Green (RoHS & no Sb/Br)	CU NIPDAU	Level-2-260C-1 YEAR	-40 to 85	E37	Samples
OPA137NA/3K	ACTIVE	SOT-23	DBV	5	3000	Green (RoHS & no Sb/Br)	CU NIPDAU	Level-2-260C-1 YEAR	-40 to 85	E37	Samples
OPA137U	ACTIVE	SOIC	D	8	75	Green (RoHS & no Sb/Br)	CU NIPDAU	Level-3-260C-168 HR	-40 to 85	OPA 137U	Samples
OPA137UA	ACTIVE	SOIC	D	8	75	Green (RoHS & no Sb/Br)	CU NIPDAU	Level-3-260C-168 HR	-40 to 85	OPA 137U A	Samples
OPA137UA/2K5	ACTIVE	SOIC	D	8	2500	Green (RoHS & no Sb/Br)	CU NIPDAU	Level-3-260C-168 HR	-40 to 85	OPA 137U A	Samples
OPA2137E/250	ACTIVE	VSSOP	DGK	8	250	Green (RoHS & no Sb/Br)	CU NIPDAU Call TI	Level-3-260C-168 HR	-40 to 85	E37	Samples
OPA2137E/2K5	ACTIVE	VSSOP	DGK	8	2500	Green (RoHS & no Sb/Br)	CU NIPDAU Call TI	Level-3-260C-168 HR	-40 to 85	E37	Samples
OPA2137E/2K5G4	ACTIVE	VSSOP	DGK	8	2500	Green (RoHS & no Sb/Br)	Call TI	Level-3-260C-168 HR	-40 to 85	E37	Samples
OPA2137EA/250	ACTIVE	VSSOP	DGK	8	250	Green (RoHS & no Sb/Br)	CU NIPDAU Call TI	Level-3-260C-168 HR		E37	Samples
OPA2137EA/250G4	ACTIVE	VSSOP	DGK	8	250	Green (RoHS & no Sb/Br)	Call TI	Level-3-260C-168 HR		E37	Samples
OPA2137EA/2K5	ACTIVE	VSSOP	DGK	8	2500	Green (RoHS & no Sb/Br)	CU NIPDAU Call TI	Level-3-260C-168 HR		E37	Samples
OPA2137P	ACTIVE	PDIP	P	8	50	Green (RoHS & no Sb/Br)	CU NIPDAU Call TI	N / A for Pkg Type		OPA2137P	Samples

Orderable Device	Status (1)	Package Type	Package Drawing	Pins	Package Qty	Eco Plan (2)	Lead/Ball Finish (6)	MSL Peak Temp (3)	Op Temp (°C)	Device Marking (4/5)	Samples
OPA2137PA	ACTIVE	PDIP	P	8	50	Green (RoHS & no Sb/Br)	CU NIPDAU Call TI	N / A for Pkg Type		OPA2137P A	Samples
OPA2137U	ACTIVE	SOIC	D	8	75	Green (RoHS & no Sb/Br)	CU NIPDAU	Level-3-260C-168 HR		OPA 2137U	Samples
OPA2137U/2K5	ACTIVE	SOIC	D	8	2500	Green (RoHS & no Sb/Br)	CU NIPDAU	Level-3-260C-168 HR		OPA 2137U	Samples
OPA2137UA	ACTIVE	SOIC	D	8	75	Green (RoHS & no Sb/Br)	CU NIPDAU	Level-3-260C-168 HR	-40 to 85	OPA 2137U A	Samples
OPA2137UA/2K5	ACTIVE	SOIC	D	8	2500	Green (RoHS & no Sb/Br)	CU NIPDAU	Level-3-260C-168 HR	-40 to 85	OPA 2137U A	Samples
OPA4137P	ACTIVE	PDIP	N	14	25	Green (RoHS & no Sb/Br)	CU NIPDAU	N / A for Pkg Type		OPA4137P	Samples
OPA4137PA	ACTIVE	PDIP	N	14	25	Green (RoHS & no Sb/Br)	CU NIPDAU	N / A for Pkg Type		OPA4137P A	Samples
OPA4137PAG4	ACTIVE	PDIP	N	14	25	Green (RoHS & no Sb/Br)	CU NIPDAU	N / A for Pkg Type		OPA4137P A	Samples
OPA4137U	ACTIVE	SOIC	D	14	50	Green (RoHS & no Sb/Br)	CU NIPDAU	Level-3-260C-168 HR	-40 to 85	OPA4137U	Samples
OPA4137U/2K5	ACTIVE	SOIC	D	14	2500	Green (RoHS & no Sb/Br)	CU NIPDAU	Level-3-260C-168 HR	-40 to 85	OPA4137U	Samples
OPA4137UA	ACTIVE	SOIC	D	14	50	Green (RoHS & no Sb/Br)	CU NIPDAU	Level-3-260C-168 HR	-40 to 85	OPA4137U A	Samples
OPA4137UA/2K5	ACTIVE	SOIC	D	14	2500	Green (RoHS & no Sb/Br)	CU NIPDAU	Level-3-260C-168 HR	-40 to 85	OPA4137U A	Samples
OPA4137UAE4	ACTIVE	SOIC	D	14	50	Green (RoHS & no Sb/Br)	CU NIPDAU	Level-3-260C-168 HR	-40 to 85	OPA4137U A	Samples
OPA4137UAG4	ACTIVE	SOIC	D	14	50	Green (RoHS & no Sb/Br)	CU NIPDAU	Level-3-260C-168 HR	-40 to 85	OPA4137U A	Samples

(1) The marketing status values are defined as follows:

ACTIVE: Product device recommended for new designs.

LIFEBUY: TI has announced that the device will be discontinued, and a lifetime-buy period is in effect.

NRND: Not recommended for new designs. Device is in production to support existing customers, but TI does not recommend using this part in a new design.

PREVIEW: Device has been announced but is not in production. Samples may or may not be available.

OBSELETE: TI has discontinued the production of the device.

⁽²⁾ **RoHS:** TI defines "RoHS" to mean semiconductor products that are compliant with the current EU RoHS requirements for all 10 RoHS substances, including the requirement that RoHS substance do not exceed 0.1% by weight in homogeneous materials. Where designed to be soldered at high temperatures, "RoHS" products are suitable for use in specified lead-free processes. TI may reference these types of products as "Pb-Free".

RoHS Exempt: TI defines "RoHS Exempt" to mean products that contain lead but are compliant with EU RoHS pursuant to a specific EU RoHS exemption.

Green: TI defines "Green" to mean the content of Chlorine (Cl) and Bromine (Br) based flame retardants meet JS709B low halogen requirements of ≤ 1000 ppm threshold. Antimony trioxide based flame retardants must also meet the ≤ 1000 ppm threshold requirement.

⁽³⁾ MSL, Peak Temp. - The Moisture Sensitivity Level rating according to the JEDEC industry standard classifications, and peak solder temperature.

⁽⁴⁾ There may be additional marking, which relates to the logo, the lot trace code information, or the environmental category on the device.

⁽⁵⁾ Multiple Device Markings will be inside parentheses. Only one Device Marking contained in parentheses and separated by a "-" will appear on a device. If a line is indented then it is a continuation of the previous line and the two combined represent the entire Device Marking for that device.

⁽⁶⁾ Lead/Ball Finish - Orderable Devices may have multiple material finish options. Finish options are separated by a vertical ruled line. Lead/Ball Finish values may wrap to two lines if the finish value exceeds the maximum column width.

Important Information and Disclaimer: The information provided on this page represents TI's knowledge and belief as of the date that it is provided. TI bases its knowledge and belief on information provided by third parties, and makes no representation or warranty as to the accuracy of such information. Efforts are underway to better integrate information from third parties. TI has taken and continues to take reasonable steps to provide representative and accurate information but may not have conducted destructive testing or chemical analysis on incoming materials and chemicals. TI and TI suppliers consider certain information to be proprietary, and thus CAS numbers and other limited information may not be available for release.

In no event shall TI's liability arising out of such information exceed the total purchase price of the TI part(s) at issue in this document sold by TI to Customer on an annual basis.

TAPE AND REEL INFORMATION



QUADRANT ASSIGNMENTS FOR PIN 1 ORIENTATION IN TAPE



*All dimensions are nominal

Device	Package Type	Package Drawing	Pins	SPQ	Reel Diameter (mm)	Reel Width W1 (mm)	A0 (mm)	B0 (mm)	K0 (mm)	P1 (mm)	W (mm)	Pin1 Quadrant
OPA137N/250	SOT-23	DBV	5	250	178.0	8.4	3.3	3.2	1.4	4.0	8.0	Q3
OPA137N/3K	SOT-23	DBV	5	3000	178.0	8.4	3.3	3.2	1.4	4.0	8.0	Q3
OPA137NA/250	SOT-23	DBV	5	250	178.0	8.4	3.23	3.17	1.37	4.0	8.0	Q3
OPA137NA/3K	SOT-23	DBV	5	3000	178.0	8.4	3.3	3.2	1.4	4.0	8.0	Q3
OPA137UA/2K5	SOIC	D	8	2500	330.0	12.4	6.4	5.2	2.1	8.0	12.0	Q1
OPA2137E/250	VSSOP	DGK	8	250	180.0	12.4	5.3	3.4	1.4	8.0	12.0	Q1
OPA2137E/2K5	VSSOP	DGK	8	2500	330.0	12.4	5.3	3.4	1.4	8.0	12.0	Q1
OPA2137EA/250	VSSOP	DGK	8	250	180.0	12.4	5.3	3.4	1.4	8.0	12.0	Q1
OPA2137EA/2K5	VSSOP	DGK	8	2500	330.0	12.4	5.3	3.4	1.4	8.0	12.0	Q1
OPA2137U/2K5	SOIC	D	8	2500	330.0	12.4	6.4	5.2	2.1	8.0	12.0	Q1
OPA2137UA/2K5	SOIC	D	8	2500	330.0	12.4	6.4	5.2	2.1	8.0	12.0	Q1
OPA4137U/2K5	SOIC	D	14	2500	330.0	16.4	6.5	9.0	2.1	8.0	16.0	Q1
OPA4137UA/2K5	SOIC	D	14	2500	330.0	16.4	6.5	9.0	2.1	8.0	16.0	Q1

TAPE AND REEL BOX DIMENSIONS

*All dimensions are nominal

Device	Package Type	Package Drawing	Pins	SPQ	Length (mm)	Width (mm)	Height (mm)
OPA137N/250	SOT-23	DBV	5	250	565.0	140.0	75.0
OPA137N/3K	SOT-23	DBV	5	3000	565.0	140.0	75.0
OPA137NA/250	SOT-23	DBV	5	250	565.0	140.0	75.0
OPA137NA/3K	SOT-23	DBV	5	3000	565.0	140.0	75.0
OPA137UA/2K5	SOIC	D	8	2500	367.0	367.0	35.0
OPA2137E/250	VSSOP	DGK	8	250	210.0	185.0	35.0
OPA2137E/2K5	VSSOP	DGK	8	2500	367.0	367.0	35.0
OPA2137EA/250	VSSOP	DGK	8	250	210.0	185.0	35.0
OPA2137EA/2K5	VSSOP	DGK	8	2500	367.0	367.0	35.0
OPA2137U/2K5	SOIC	D	8	2500	367.0	367.0	35.0
OPA2137UA/2K5	SOIC	D	8	2500	367.0	367.0	35.0
OPA4137U/2K5	SOIC	D	14	2500	367.0	367.0	38.0
OPA4137UA/2K5	SOIC	D	14	2500	367.0	367.0	38.0

IMPORTANT NOTICE AND DISCLAIMER

TI PROVIDES TECHNICAL AND RELIABILITY DATA (INCLUDING DATASHEETS), DESIGN RESOURCES (INCLUDING REFERENCE DESIGNS), APPLICATION OR OTHER DESIGN ADVICE, WEB TOOLS, SAFETY INFORMATION, AND OTHER RESOURCES "AS IS" AND WITH ALL FAULTS, AND DISCLAIMS ALL WARRANTIES, EXPRESS AND IMPLIED, INCLUDING WITHOUT LIMITATION ANY IMPLIED WARRANTIES OF MERCHANTABILITY, FITNESS FOR A PARTICULAR PURPOSE OR NON-INFRINGEMENT OF THIRD PARTY INTELLECTUAL PROPERTY RIGHTS.

These resources are intended for skilled developers designing with TI products. You are solely responsible for (1) selecting the appropriate TI products for your application, (2) designing, validating and testing your application, and (3) ensuring your application meets applicable standards, and any other safety, security, or other requirements. These resources are subject to change without notice. TI grants you permission to use these resources only for development of an application that uses the TI products described in the resource. Other reproduction and display of these resources is prohibited. No license is granted to any other TI intellectual property right or to any third party intellectual property right. TI disclaims responsibility for, and you will fully indemnify TI and its representatives against, any claims, damages, costs, losses, and liabilities arising out of your use of these resources.

TI's products are provided subject to TI's Terms of Sale (www.ti.com/legal/termsofsale.html) or other applicable terms available either on ti.com or provided in conjunction with such TI products. TI's provision of these resources does not expand or otherwise alter TI's applicable warranties or warranty disclaimers for TI products.

Mailing Address: Texas Instruments, Post Office Box 655303, Dallas, Texas 75265
Copyright © 2019, Texas Instruments Incorporated

Looking for pricing, stock, or lifecycle information?

Click below to explore more details on WIN SOURCE:

 [View OPA137U on WIN SOURCE](#)

 [Texas Instruments](#) Information

Optimize Your Supply Chain with WIN SOURCE Solutions

-  Global Sourcing Solution
-  Obsolete Management
-  Cost Control Management
-  Shortage Management
-  Alternative Solution
-  Excess Inventory Management