



# THE DATASHEET OF OPA2134UA/2K5



## OPAx134 SoundPlus™ High Performance Audio Operational Amplifiers

### 1 Features

- Superior Sound Quality
- Ultra Low Distortion: 0.00008%
- Low Noise: 8 nV/√Hz
- True FET-Input:  $I_B = 5\text{pA}$
- High Speed:
  - Slew Rate: 20 V/μs
  - Bandwidth: 8 MHz
- High Open-Loop Gain: 120 dB (600 Ω)
- Wide Supply Range: ±2.5 V to ±18 V
- Single, Dual, and Quad Versions

### 2 Applications

- Professional Audio and Music
- Line Drivers
- Line Receivers
- Multimedia Audio
- Active Filters
- Preamplifiers
- Integrators
- Crossover Networks

THD+Noise vs Frequency

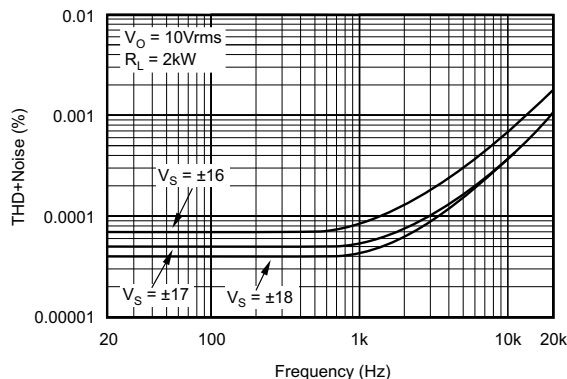

### 3 Description

The OPA134 series are ultra-low distortion, low-noise operational amplifiers fully specified for audio applications. A true FET input stage is incorporated to provide superior sound quality and speed for exceptional audio performance. This, in combination with high output drive capability and excellent DC performance, allows for use in a wide variety of demanding applications. In addition, the OPA134 has a wide output swing, to within 1 V of the rails, allowing increased headroom and making it ideal for use in any audio circuit.

The OPA134 SoundPlus™ audio operational amplifiers are easy to use and free from phase-inversion and the overload problems often found in common FET-input operational amplifiers. They can be operated from ±2.5-V to ±18-V power supplies. Input cascode circuitry provides excellent common-mode rejection and maintains low input bias current over its wide input voltage range, minimizing distortion. OPA134 series operational amplifiers are unity-gain stable and provide excellent dynamic behavior over a wide range of load conditions, including high load capacitance. The dual and quad versions feature completely independent circuitry for lowest crosstalk and freedom from interaction, even when overdriven or overloaded.

Single and dual versions are available in 8-pin DIP and SO-8 surface-mount packages in standard configurations. The quad is available in 14-pin DIP and SO-14 surface mount packages. All are specified for –40°C to 85°C operation. A SPICE macromodel is available for design analysis.

Device Information<sup>(1)</sup>

PART NUMBER	PACKAGE	BODY SIZE (NOM)
OPA134	SOIC (8)	3.91 mm × 4.90 mm
	PDIP (8)	6.35 mm × 9.81 mm
OPA2134	SOIC (8)	3.91 mm × 4.90 mm
	PDIP (8)	6.35 mm × 9.81 mm
OPA4134	SOIC (14)	3.91 mm × 8.65 mm

(1) For all available packages, see the orderable addendum at the end of the data sheet.



## Table of Contents

<b>1 Features</b> .....	<b>1</b>	<b>8 Application and Implementation</b> .....	<b>15</b>
<b>2 Applications</b> .....	<b>1</b>	8.1 Application Information.....	15
<b>3 Description</b> .....	<b>1</b>	8.2 Typical Application .....	16
<b>4 Revision History</b> .....	<b>2</b>	<b>9 Power Supply Recommendations</b> .....	<b>18</b>
<b>5 Pin Configuration and Functions</b> .....	<b>3</b>	<b>10 Layout</b> .....	<b>18</b>
<b>6 Specifications</b> .....	<b>4</b>	10.1 Layout Guidelines .....	18
6.1 Absolute Maximum Ratings .....	4	10.2 Layout Example .....	19
6.2 ESD Ratings.....	4	<b>11 Device and Documentation Support</b> .....	<b>20</b>
6.3 Recommended Operating Conditions.....	4	11.1 Device Support .....	20
6.4 Electrical Characteristics.....	5	11.2 Documentation Support .....	20
6.5 Typical Characteristics.....	7	11.3 Related Links .....	20
<b>7 Detailed Description</b> .....	<b>12</b>	11.4 Community Resources.....	21
7.1 Overview .....	12	11.5 Trademarks .....	21
7.2 Functional Block Diagram .....	12	11.6 Electrostatic Discharge Caution.....	21
7.3 Feature Description.....	12	11.7 Glossary .....	21
7.4 Device Functional Modes.....	14	<b>12 Mechanical, Packaging, and Orderable Information</b> .....	<b>21</b>

## 4 Revision History

NOTE: Page numbers for previous revisions may differ from page numbers in the current version.

### Changes from Original (September 2000) to Revision A

Page

- Added *ESD Ratings* table, *Feature Description* section, *Device Functional Modes*, *Application and Implementation* section, *Power Supply Recommendations* section, *Layout* section, *Device and Documentation Support* section, and *Mechanical, Packaging, and Orderable Information* section. ....

1

## 5 Pin Configuration and Functions

**OPA134: P and D Packages**  
8-Pin PDIP and 8-Pin SOIC  
Top View

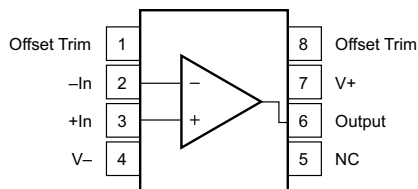

**OPA2134: P and D Packages**  
8-Pin PDIP and 8-Pin SOIC  
Top View

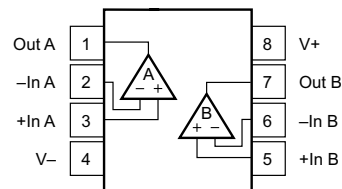

**OPA4134: P and D Packages**  
14-Pin PDIP and 14-Pin SOIC  
Top View

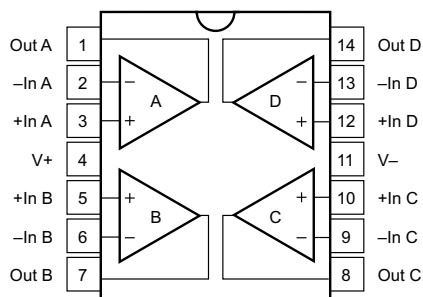

### Pin Functions: OPA134

PIN		I/O	DESCRIPTION
NAME	NO.		
Offset Trim	1	I	Input offset voltage adjust
-In	2	I	Inverting input
+In	3	I	Noninverting input
V-	4	—	Negative power supply
NC	5	—	No internal connection. Can be left floating.
Output	6	O	Output
V+	7	—	Positive power supply
Offset Trim	8	I	Input offset voltage adjust

### Pin Functions: OPA2134 and OPA4134

PIN			I/O	DESCRIPTION
NAME	OPA2134 NO.	OPA4134 NO.		
Out A	1	1	O	Output channel A
-In A	2	2	I	Inverting input channel A
+In A	3	3	I	Noninverting input channel A
V+	8	4	—	Positive power supply
+In B	5	5	I	Noninverting input channel B
-In B	6	6	I	Inverting input channel B
Out B	7	7	O	Output channel B
Out C	—	8	O	Output channel C
-In C	—	9	I	Inverting input channel C
+In C	—	10	I	Noninverting input channel C

**Pin Functions: OPA2134 and OPA4134 (continued)**

NAME	PIN		I/O	DESCRIPTION
	OPA2134 NO.	OPA4134 NO.		
V–	4	11	—	Negative power supply
+In D	—	12	I	Noninverting input channel D
–In D	—	13	I	Inverting input channel D
Out D	—	14	O	Output channel D

## 6 Specifications

### 6.1 Absolute Maximum Ratings

 over operating free-air temperature range (unless otherwise noted) <sup>(1)</sup>

	MIN	MAX	UNIT
Supply voltage, V+ to V–		36	V
Input voltage	(V–) –0.7	(V+) +0.7	V
Output short circuit <sup>(2)</sup>		Continuous	
Operating temperature	–40	125	°C
Junction temperature		150	°C
Lead temperature (soldering, 10 s)		300	°C
T <sub>stg</sub> Storage temperature	–55	125	°C

- (1) Stresses beyond those listed under *Absolute Maximum Ratings* may cause permanent damage to the device. These are stress ratings only, which do not imply functional operation of the device at these or any other conditions beyond those indicated under *Recommended Operating Conditions*. Exposure to absolute-maximum-rated conditions for extended periods may affect device reliability.
- (2) Short-circuit to ground, one amplifier per package.

### 6.2 ESD Ratings

	VALUE	UNIT
<b>OPA134 in PDIP and SOIC Package, OPA2134 and OPA4134 in PDIP Package</b>		
V <sub>(ESD)</sub> Electrostatic discharge	Human-body model (HBM), per ANSI/ESDA/JEDEC JS-001 <sup>(1)</sup>	±2000 V
<b>OPA2134 in SOIC Package</b>		
V <sub>(ESD)</sub> Electrostatic discharge	Human-body model (HBM), per ANSI/ESDA/JEDEC JS-001 <sup>(1)</sup>	±2000
	Charged-device model (CDM), per JEDEC specification JESD22-C101 <sup>(2)</sup>	±500
<b>OPA4134 in SOIC Package</b>		
V <sub>(ESD)</sub> Electrostatic discharge	Human-body model (HBM), per ANSI/ESDA/JEDEC JS-001 <sup>(1)</sup>	±2000
	Charged-device model (CDM), per JEDEC specification JESD22-C101 <sup>(2)</sup>	±200

- (1) JEDEC document JEP155 states that 500-V HBM allows safe manufacturing with a standard ESD control process.
- (2) JEDEC document JEP157 states that 250-V CDM allows safe manufacturing with a standard ESD control process.

### 6.3 Recommended Operating Conditions

over operating free-air temperature range (unless otherwise noted)

	MIN	NOM	MAX	UNIT
V <sub>S</sub> Supply voltage, V <sub>S</sub> = (V+) – (V–)	±2.5	±15	±18	V
T <sub>A</sub> Specified temperature	–40		85	°C

## 6.4 Electrical Characteristics

At  $T_A = +25^\circ\text{C}$ ,  $V_S = \pm 15\text{ V}$ , unless otherwise noted

PARAMETER		TEST CONDITIONS	MIN	TYP	MAX	UNIT
<b>AUDIO PERFORMANCE</b>						
Total Harmonic Distortion + Noise	G = 1, f = 1 kHz, $V_O = 3\text{ V}_{\text{rms}}$	$R_L = 2\text{ k}\Omega$	0.00008%			
		$R_L = 600\ \Omega$	0.00015%			
Intermodulation Distortion	G = 1, f = 1 kHz, $V_O = 1\text{ V}_{\text{p-p}}$		-98			dB
Headroom <sup>(1)</sup>	THD < 0.01%, $R_L = 2\text{ k}\Omega$ , $V_S = 18\text{ V}$		23.6			dBu
<b>FREQUENCY RESPONSE</b>						
Gain-Bandwidth Product			8			MHz
Slew Rate <sup>(2)</sup>			$\pm 15$	$\pm 20$		V/ $\mu\text{s}$
Full Power Bandwidth			1.3			MHz
Settling Time 0.1%	G = 1, 10-V Step, $C_L = 100\text{ pF}$		0.7			$\mu\text{s}$
Settling Time 0.01%	G = 1, 10-V Step, $C_L = 100\text{ pF}$		1			$\mu\text{s}$
Overload Recovery Time	$(V_{\text{IN}}) \times (\text{Gain}) = V_S$		0.5			$\mu\text{s}$
<b>NOISE</b>						
Input Voltage Noise	Noise Voltage, f = 20 Hz to 20 kHz		1.2			$\mu\text{V}_{\text{rms}}$
	Noise Density, f = 1 kHz		8			nV/ $\sqrt{\text{Hz}}$
Current Noise Density, f = 1 kHz			3			fA/ $\sqrt{\text{Hz}}$
<b>OFFSET VOLTAGE</b>						
Input Offset Voltage			$\pm 0.5$	$\pm 2$		mV
	$T_A = -40^\circ\text{C}$ to $85^\circ\text{C}$		$\pm 1$	$\pm 3^{(3)}$		
Input Offset Voltage vs Temperature	$T_A = -40^\circ\text{C}$ to $85^\circ\text{C}$		$\pm 2$			$\mu\text{V}/^\circ\text{C}$
Input Offset Voltage vs Power Supply (PSRR)	$V_S = \pm 2.5\text{ V}$ to $\pm 18\text{ V}$		90	106		dB
Channel Separation (Dual, Quad)	DC, $R_L = 2\text{ k}\Omega$		135			dB
	f = 20 kHz, $R_L = 2\text{ k}\Omega$		130			
<b>INPUT BIAS CURRENT</b>						
Input Bias Current <sup>(4)</sup>	$V_{\text{CM}} = 0\text{ V}$		5	$\pm 100$		pA
Input Bias Current vs Temperature <sup>(3)</sup>			See <i>Typical Characteristics</i>		$\pm 5$	nA
Input Offset Current <sup>(4)</sup>	$V_{\text{CM}} = 0\text{ V}$		$\pm 2$	$\pm 50$		pA
<b>INPUT VOLTAGE RANGE</b>						
Common-Mode Voltage Range			(V-)+2.5	13	(V+)-2.5	V
Common-Mode Rejection	$V_{\text{CM}} = -12.5\text{ V}$ to $12.5\text{ V}$		86	100		dB
	$T_A = -40^\circ\text{C}$ to $85^\circ\text{C}$		90			
<b>INPUT IMPEDANCE</b>						
Differential			$10^{13} \parallel 2$			$\Omega \parallel \text{pF}$
Common-Mode	$V_{\text{CM}} = -12.5\text{ V}$ to $12.5\text{ V}$		$10^{13} \parallel 5$			$\Omega \parallel \text{pF}$
<b>OPEN-LOOP GAIN</b>						
Open-Loop Voltage Gain	$R_L = 10\text{ k}\Omega$ , $V_O = -14.5\text{ V}$ to $13.8\text{ V}$		104	120		dB
	$R_L = 2\text{ k}\Omega$ , $V_O = -13.8\text{ V}$ to $13.5\text{ V}$		104	120		
	$R_L = 600\ \Omega$ , $V_O = -12.8\text{ V}$ to $12.5\text{ V}$		104	120		

(1) dBu =  $20 \cdot \log(V_{\text{rms}}/0.7746)$  where  $V_{\text{rms}}$  is the maximum output voltage for which THD+Noise is less than 0.01%. See THD+Noise text.

(2) Proposed by design.

(3) Proposed by wafer-level test to 95% confidence level.

(4) High-speed test at  $T_J = 25^\circ\text{C}$ .

**OPA134, OPA2134, OPA4134**

SBOS058A – DECEMBER 1997 – REVISED OCTOBER 2015

[www.ti.com](http://www.ti.com)
**Electrical Characteristics (continued)**

 At  $T_A = +25^\circ\text{C}$ ,  $V_S = \pm 15\text{ V}$ , unless otherwise noted

PARAMETER	TEST CONDITIONS	MIN	TYP	MAX	UNIT
<b>OUTPUT</b>					
Voltage Output	$R_L = 10\text{ k}\Omega$	(V-) + 0.5		(V+) - 1.2	V
	$R_L = 2\text{ k}\Omega$	(V-) + 1.2		(V+) - 1.5	
	$R_L = 600\ \Omega$	(V-) + 2.2		(V+) - 2.5	
Output Current			$\pm 35$		mA
Output Impedance, Closed-Loop <sup>(5)</sup>	$f = 10\text{ kHz}$		0.01		$\Omega$
Output Impedance, Open-Loop	$f = 10\text{ kHz}$		10		$\Omega$
Short-Circuit Current			$\pm 40$		mA
Capacitive Load Drive (Stable Operation)			See <i>Typical Characteristics</i>		
<b>POWER SUPPLY</b>					
Specified Operating Voltage			$\pm 15$		V
Operating Voltage Range		$\pm 2.5$		$\pm 18$	V
Quiescent Current (per amplifier)	$I_O = 0$		4	5	mA
<b>TEMPERATURE RANGE</b>					
Specified Range		-40		85	$^\circ\text{C}$
Operating Range		-55		125	$^\circ\text{C}$

 (5) See [Figure 14](#)

### 6.5 Typical Characteristics

At  $T_A = 25^\circ\text{C}$ ,  $V_S = 15\text{ V}$ ,  $R_L = 2\text{ k}\Omega$ , unless otherwise noted.

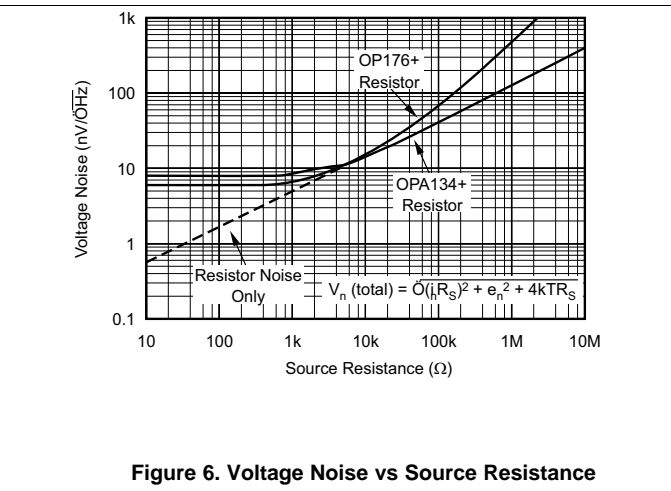
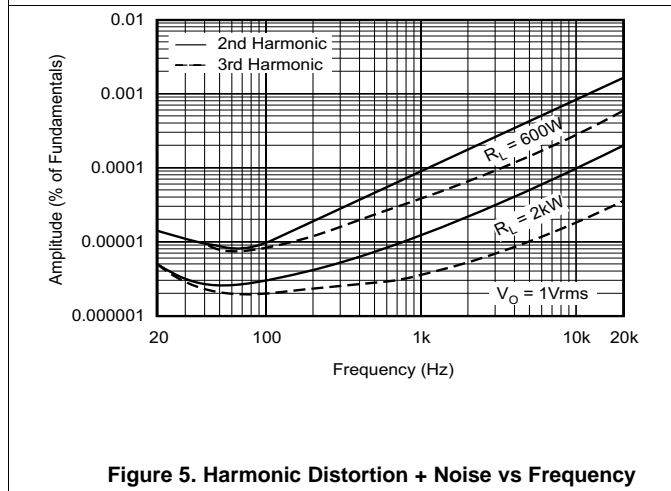
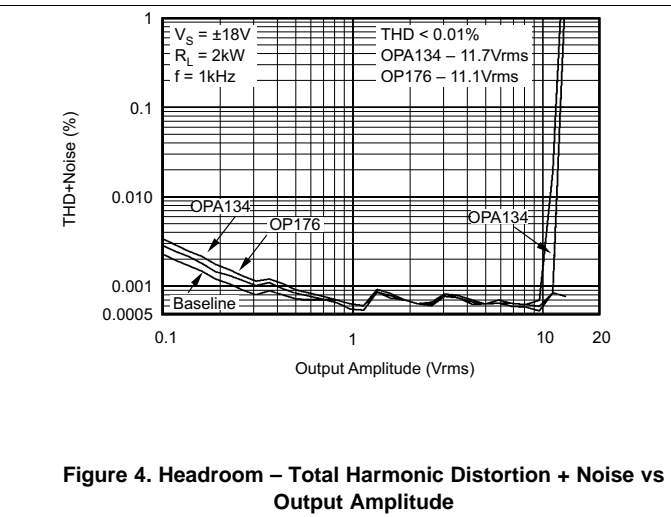
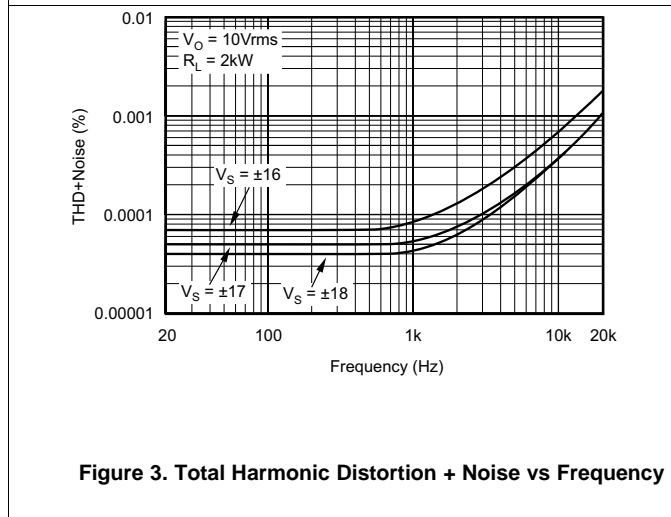
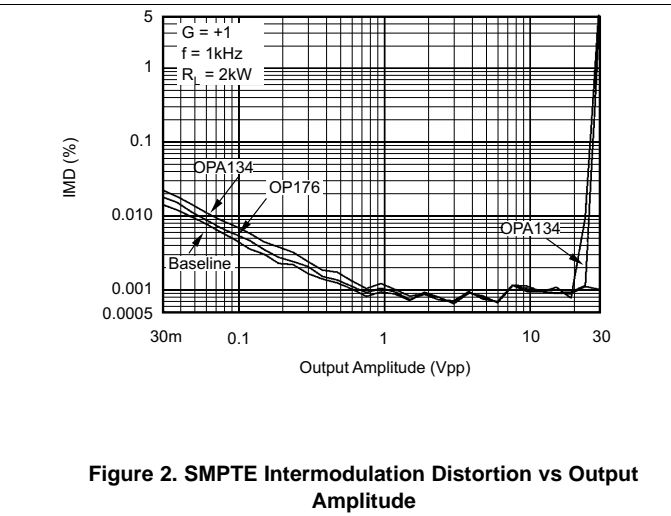
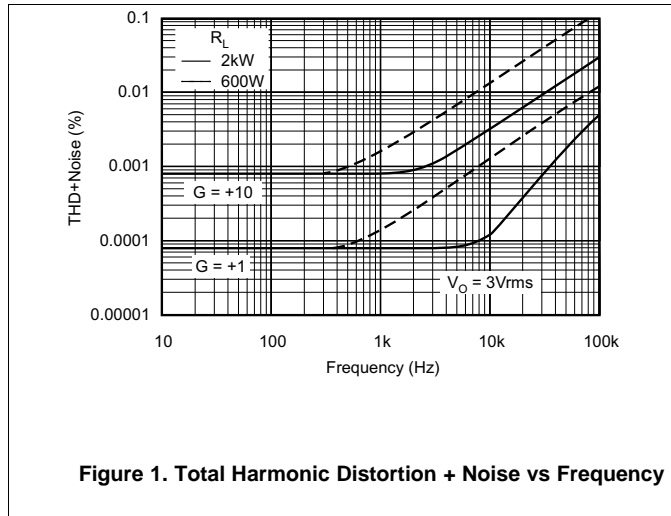

Typical Characteristics (continued)

At  $T_A = 25^\circ\text{C}$ ,  $V_S = 15\text{ V}$ ,  $R_L = 2\text{ k}\Omega$ , unless otherwise noted.

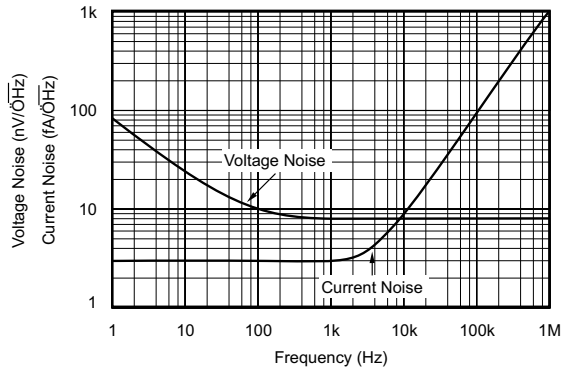

Figure 7. Input Voltage and Current Noise Spectral Density vs Frequency

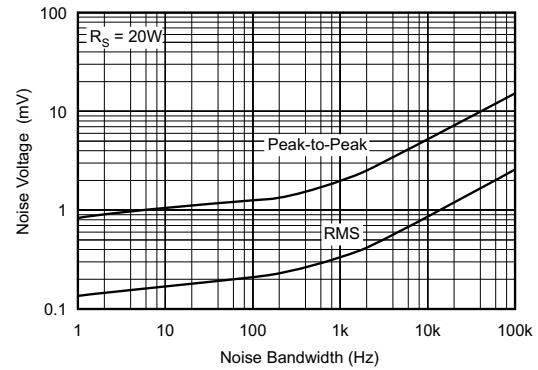

Figure 8. Input-Referred Noise Voltage vs Noise Bandwidth

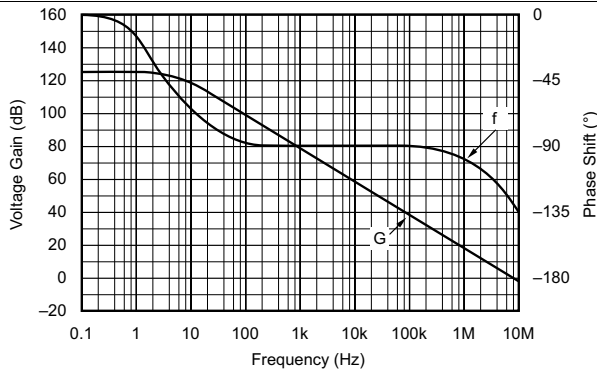

Figure 9. Open-Loop Gain and Phase vs Frequency

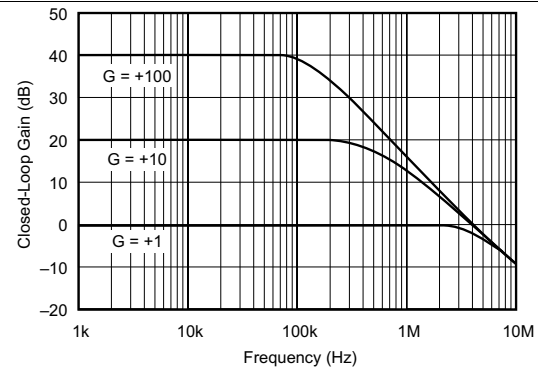

Figure 10. Closed-Loop Gain vs Frequency

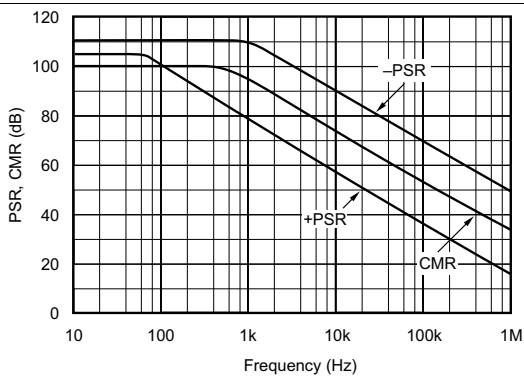

Figure 11. Power Supply and Common-Mode Rejection vs Frequency

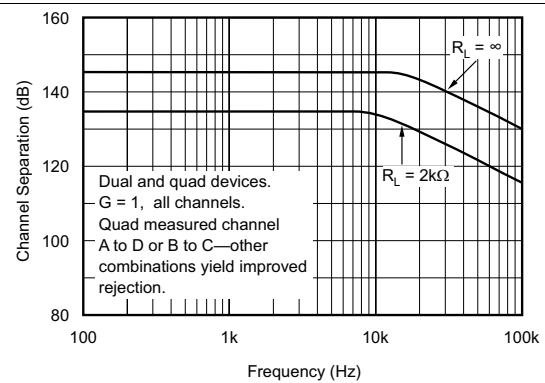
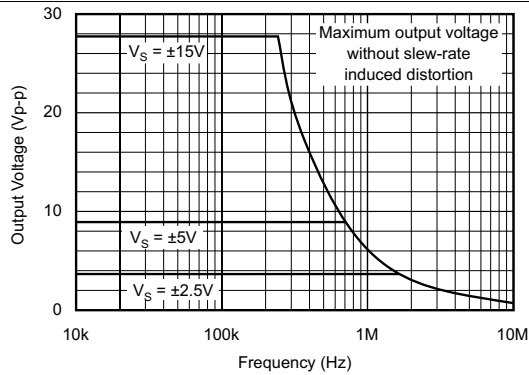

Figure 12. Channel Separation vs Frequency

**Typical Characteristics (continued)**

At  $T_A = 25^\circ\text{C}$ ,  $V_S = 15\text{ V}$ ,  $R_L = 2\text{ k}\Omega$ , unless otherwise noted.



**Figure 13. Maximum Output Voltage vs Frequency**

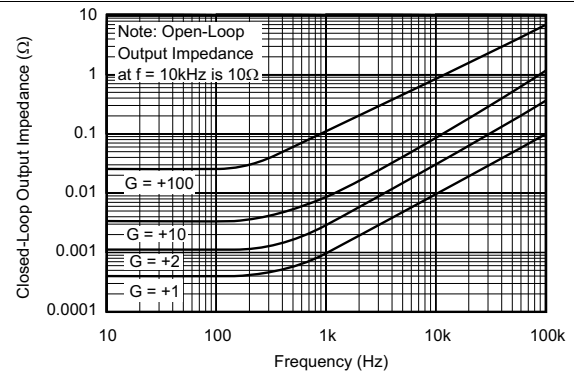

**Figure 14. Closed-Loop Output Impedance vs Frequency**

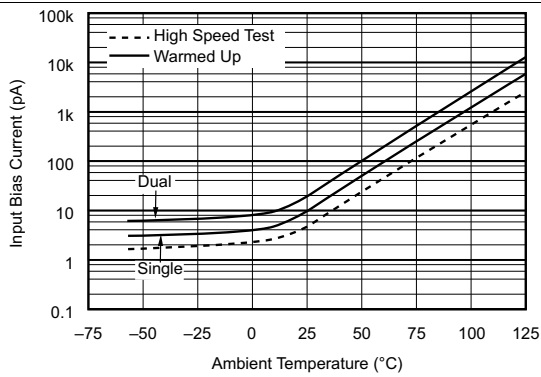

**Figure 15. Input Bias Current vs Temperature**

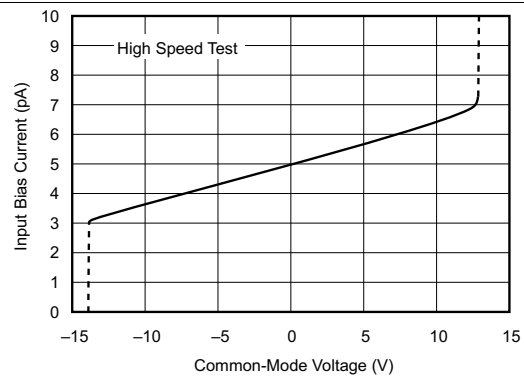

**Figure 16. Input Bias Current vs Input Common-Mode Voltage**

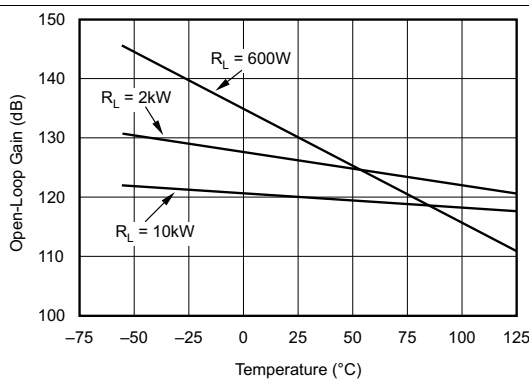

**Figure 17. Open-Loop Gain vs Temperature**

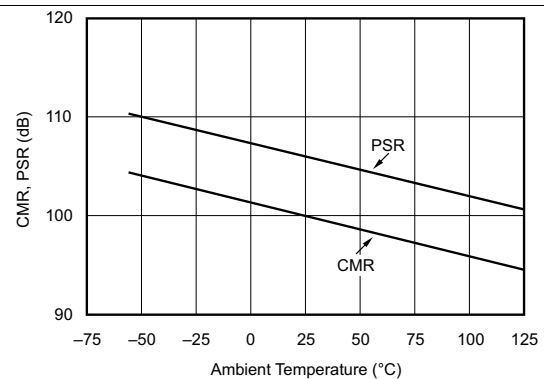

**Figure 18. CMR, PSR vs Temperature**

**Typical Characteristics (continued)**

At  $T_A = 25^\circ\text{C}$ ,  $V_S = 15\text{ V}$ ,  $R_L = 2\text{ k}\Omega$ , unless otherwise noted.

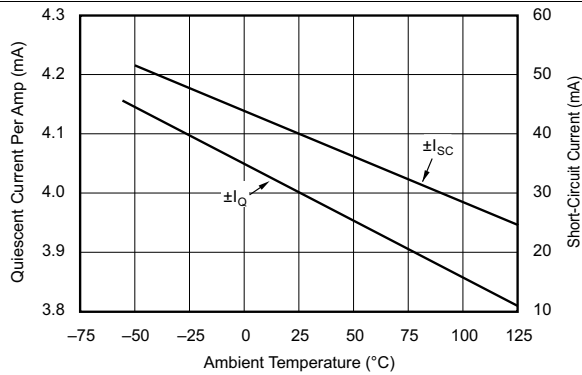

**Figure 19. Quiescent Current and Short-Circuit Current vs Temperature**

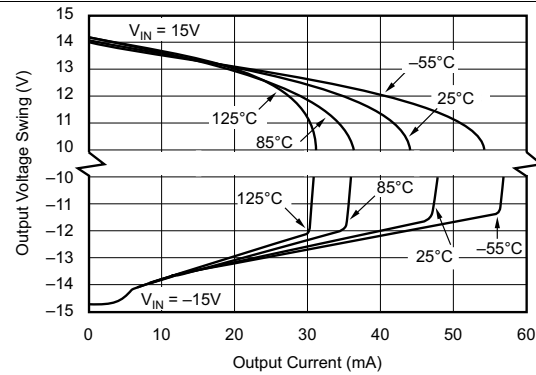

**Figure 20. Output Voltage Swing vs Output Current**

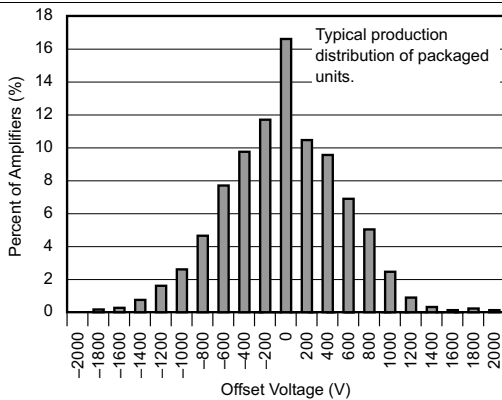

**Figure 21. Offset Voltage Production Distribution**

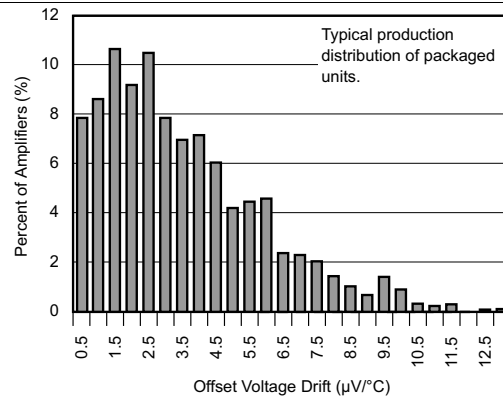

**Figure 22. Offset Voltage Drift Production Distribution**

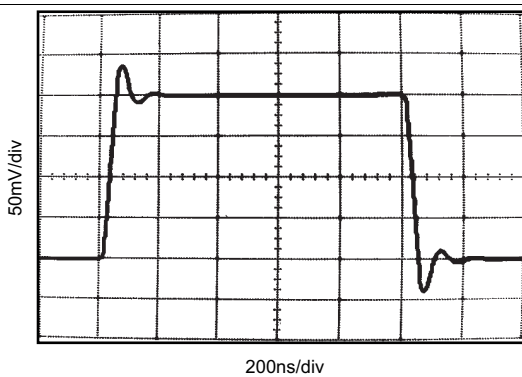

**Figure 23. Small-Signal Step Response  $G = 1$ ,  $C_L = 100\text{ pF}$**

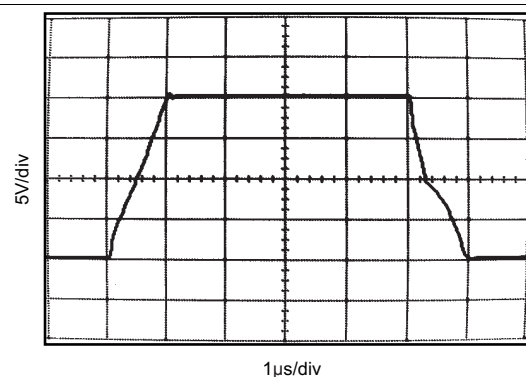

**Figure 24. Large-Signal Step Response  $G = 1$ ,  $C_L = 100\text{ pF}$**

**Typical Characteristics (continued)**

At  $T_A = 25^\circ\text{C}$ ,  $V_S = 15\text{ V}$ ,  $R_L = 2\text{ k}\Omega$ , unless otherwise noted.

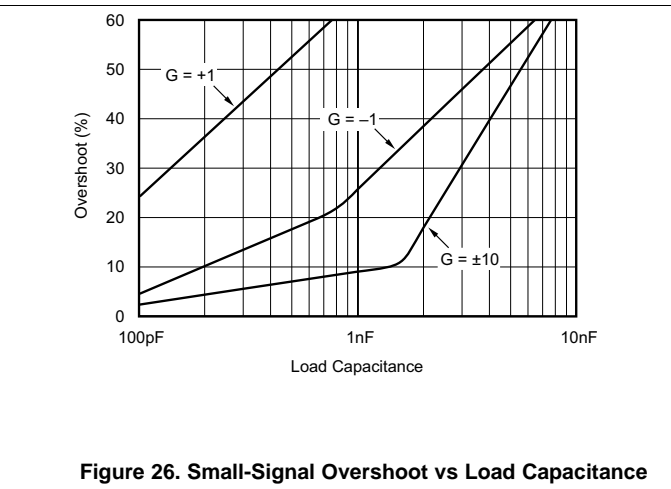
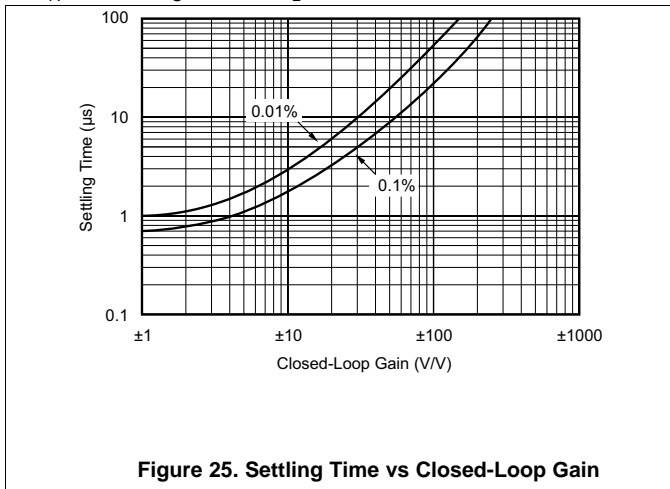

## 7 Detailed Description

### 7.1 Overview

The OPA134 series are ultra-low distortion, low-noise operational amplifiers fully specified for audio applications. A true FET input stage is incorporated to provide superior sound quality and speed for exceptional audio performance. This, in combination with high output drive capability and excellent DC performance, allows for use in a wide variety of demanding applications. In addition, the OPA134 has a wide output swing, to within 1 V of the rails, allowing increased headroom and making it ideal for use in any audio circuit.

### 7.2 Functional Block Diagram

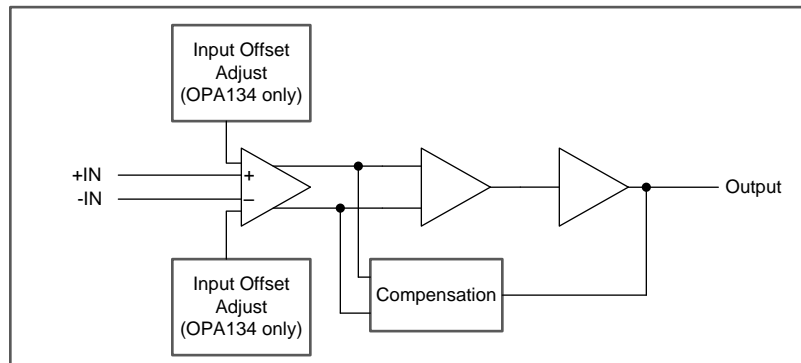

### 7.3 Feature Description

#### 7.3.1 Total Harmonic Distortion

The OPA134 series of operational amplifiers have excellent distortion characteristics. THD+Noise is below 0.0004% throughout the audio frequency range, 20 Hz to 20 kHz, with a 2-k $\Omega$  load. In addition, distortion remains relatively flat through its wide output voltage swing range, providing increased headroom compared to other audio amplifiers, including the OP176/275.

Headroom is a subjective measurement, and can be thought of as the maximum output amplitude allowed while still maintaining a low level of distortion. In an attempt to quantify headroom, TI defines very low distortion as 0.01%. Headroom is expressed as a ratio which compares the maximum allowable output voltage level to a standard output level (1 mW into 600  $\Omega$ , or 0.7746 V<sub>rms</sub>). Therefore, OPA134 series of operational amplifiers, which have a maximum allowable output voltage level of 11.7 V<sub>rms</sub> (THD+Noise < 0.01%), have a headroom specification of 23.6 dBu. See [Figure 4](#).

#### 7.3.2 Distortion Measurements

The distortion produced by OPA134 series of operational amplifiers is below the measurement limit of all known commercially-available equipment. However, a special test circuit can extend the measurement capabilities.

Operational amplifier distortion can be considered an internal error source which can be referred to the input. [Figure 27](#) shows a circuit which causes the operational amplifier distortion to be 101 times greater than that which the operational amplifier normally produces. The addition of R3 to the otherwise standard non-inverting amplifier configuration alters the feedback factor or noise gain of the circuit. The closed-loop gain is unchanged, but the feedback available for error correction is reduced by a factor of 101, thus extending the resolution by 101. The input signal and load applied to the operational amplifier are the same as with conventional feedback without R3. The value of R3 should be kept small to minimize its effect on the distortion measurements.

Feature Description (continued)

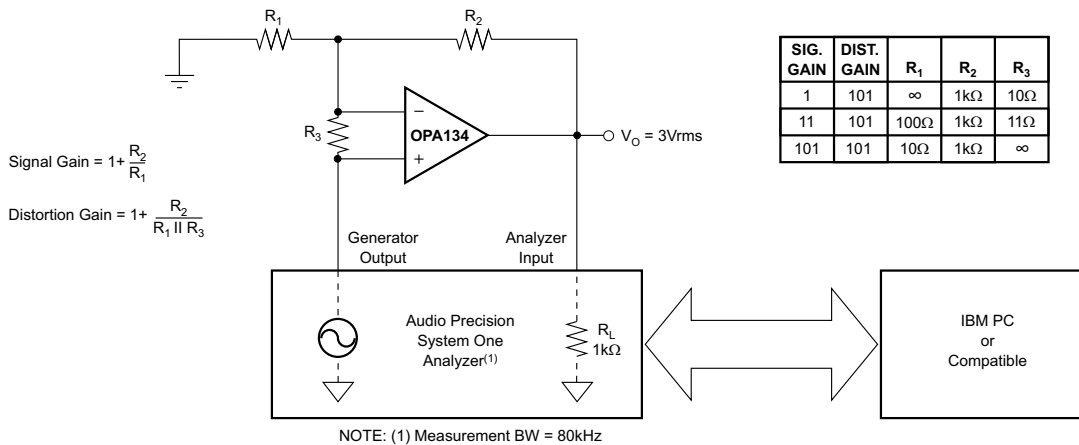

Figure 27. Distortion Test Circuit

This technique can be verified by duplicating measurements at high gain or high frequency, where the distortion is within the measurement capability of the test equipment. Measurements for this data sheet were made with an Audio Precision distortion and noise analyzer, which greatly simplifies repetitive measurements. The measurement technique can, however, be performed with manual distortion measurement instruments.

7.3.3 Source Impedance and Distortion

For lowest distortion with a source or feedback network with an impedance greater than 2 kΩ, the impedance seen by the positive and negative inputs in noninverting applications should be matched. The p-channel JFETs in the FET input stage exhibit a varying input capacitance with applied common-mode input voltage. In inverting configurations, the input does not vary with input voltage, because the inverting input is held at virtual ground. However, in noninverting applications the inputs do vary, and the gate-to-source voltage is not constant. The effect is increased distortion due to the varying capacitance for unmatched source impedances greater than 2 kΩ.

To maintain low distortion, match unbalanced source impedance with the appropriate values in the feedback network as shown in Figure 28. Of course, the unbalanced impedance may be from gain-setting resistors in the feedback path. If the parallel combination of R1 and R2 is greater than 2 kΩ, use a matching impedance on the noninverting input. As always, minimize resistor values to reduce the effects of thermal noise.

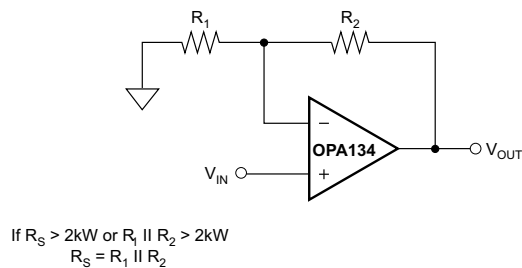

Figure 28. Impedance Matching for Maintaining Low Distortion in Non-Inverting Circuits

7.3.4 Phase Reversal Protection

The OPA134 series of operational amplifiers are free from output phase-reversal problems. Many audio operational amplifiers, such as the OP176, exhibit phase-reversal of the output when the input common-mode voltage range is exceeded. This can occur in voltage-follower circuits, causing serious problems in control loop applications. The OPA134 series operational amplifiers are free from this undesirable behavior even with inputs of 10-V beyond the input common-mode range.

## Feature Description (continued)

### 7.3.5 Output Current Limit

Output current is limited by internal circuitry to approximately  $\pm 40$  mA at 25°C. The limit current decreases with increasing temperature, as shown in [Figure 19](#).

## 7.4 Device Functional Modes

### 7.4.1 Noise Performance

Circuit noise is determined by the thermal noise of external resistors and operational amplifier noise. Operational amplifier noise is described by two parameters: noise voltage and noise current. The total noise is quantified by the equation:

$$V_n(\text{total}) = \sqrt{(i_n R_S)^2 e_n^2 + 4kTR_S} \quad (1)$$

With low source impedance, the current noise term is insignificant and voltage noise dominates the noise performance. At high source impedance, the current noise term becomes the dominant contributor.

Low-noise bipolar operational amplifiers such as the OPA27 and OPA37 provide low voltage noise at the expense of a higher current noise. However, OPA134 series operational amplifiers provide both low voltage noise and low current noise. This provides optimum noise performance over a wide range of sources, including reactive source impedances; refer to [Figure 6](#). Above 2-k $\Omega$  source resistance, the operational amplifier contributes little additional noise; the voltage and current terms in the total noise equation become insignificant and the source resistance term dominates. Below 2 k $\Omega$ , operational amplifier voltage noise dominates over the resistor noise, but compares favorably with other audio operational amplifiers such as the OP176.

## 8 Application and Implementation

### NOTE

Information in the following applications sections is not part of the TI component specification, and TI does not warrant its accuracy or completeness. TI's customers are responsible for determining suitability of components for their purposes. Customers should validate and test their design implementation to confirm system functionality.

### 8.1 Application Information

The OPA134 series operational amplifiers are unity-gain stable, and suitable for a wide range of audio and general-purpose applications. All circuitry is independent in the dual version, assuring normal behavior when one amplifier in a package is overdriven or short-circuited. Power supply pins should be bypassed with 10-nF ceramic capacitors or larger to minimize power supply noise.

#### 8.1.1 Operating Voltage

The OPA134 series of operational amplifiers operate with power supplies from  $\pm 2.5$  V to  $\pm 18$  V with excellent performance. Although specifications are production tested with  $\pm 15$ -V supplies, most behavior remains unchanged throughout the full operating voltage range. Parameters which vary significantly with operating voltage are shown in [Typical Characteristics](#).

#### 8.1.2 Offset Voltage Trim

Offset voltage of OPA134 series amplifiers is laser-trimmed, and usually requires no user adjustment. The OPA134 (single operational amplifier version) provides offset trim connections on pins 1 and 8, identical to 5534 amplifiers. Offset voltage can be adjusted by connecting a potentiometer as shown in [Figure 29](#). This adjustment should be used only to null the offset of the operational amplifier, not to adjust system offset or offset produced by the signal source. Nulling offset could change the offset voltage drift behavior of the operational amplifier. While it is not possible to predict the exact change in drift, the effect is usually small.

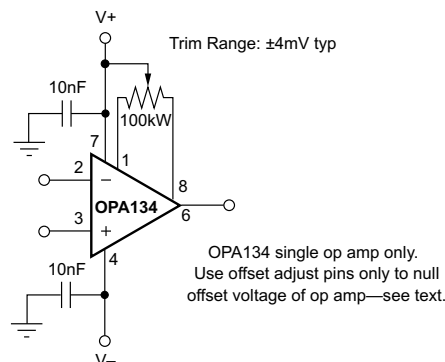

**Figure 29. OPA134 Offset Voltage Trim Circuit**

## 8.2 Typical Application

The OPAx134 family offers outstanding dc precision and AC performance. These devices operate up to 36-V supply rails and offer ultralow distortion and noise, as well as 8-MHz bandwidth and high capacitive load drive. These features make the OPAx134 a robust, high-performance operational amplifier for high-voltage professional audio applications.

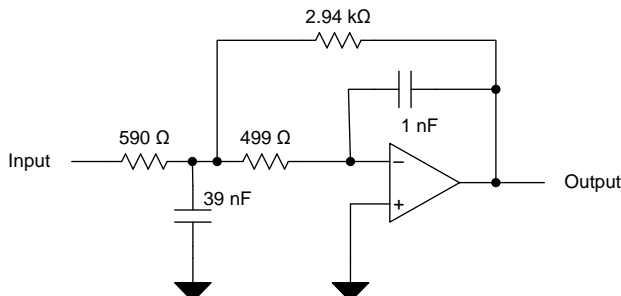

**Figure 30. OPA134 2nd Order 30-kHz, Low Pass Filter Schematic**

### 8.2.1 Design Requirements

- Gain = 5 V/V (inverting)
- Low pass cutoff frequency = 30 kHz
- –40 db/dec filter response
- Maintain less than 3-dB gain peaking in the gain versus frequency response

### 8.2.2 Detailed Design Procedure

The infinite-gain multiple-feedback circuit for a low-pass network function is shown in [Figure 30](#). The voltage transfer function is:

$$\frac{\text{Output}}{\text{Input}}(s) = \frac{-1/R_1 R_3 C_2 C_5}{s^2 + (s/C_2)(1/R_1 + 1/R_3 + 1/R_4) + 1/R_3 R_4 C_2 C_5} \quad (2)$$

This circuit produces a signal inversion. For this circuit the gain at DC and the low pass cutoff frequency are calculated using [Equation 3](#).

$$\text{Gain} = \frac{R_4}{R_1}$$

$$f_c = \frac{1}{2\pi} \sqrt{1/R_3 R_4 C_2 C_5} \quad (3)$$

Software tools are readily available to simplify filter design. [WEBENCH® Filter Designer](#) is a simple, powerful, and easy-to-use active filter design program. The WEBENCH Filter Designer lets you create optimized filter designs using a selection of TI operational amplifiers and passive components from TI's vendor partners.

Available as a web based tool from the WEBENCH® Design Center, [WEBENCH® Filter Designer](#) allows you to design, optimize, and simulate complete multistage active filter solutions within minutes.

## Typical Application (continued)

### 8.2.3 Application Curve

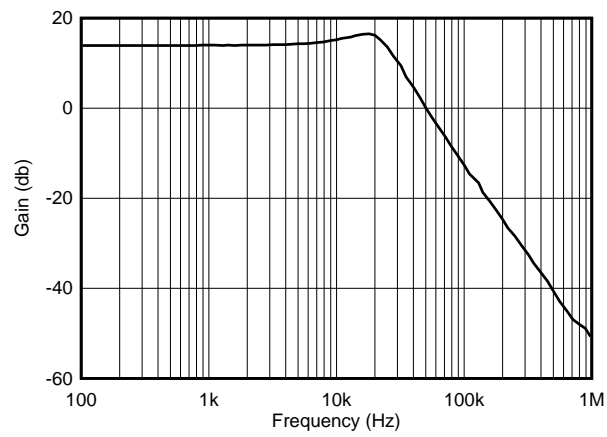

Figure 31. OPA134 2nd Order 30-kHz, Low Pass Filter Response

## 9 Power Supply Recommendations

The OPAx134 is specified for operation from 5 V to 36 V ( $\pm 2.5$  V to  $\pm 18$  V); many specifications apply from  $-40^{\circ}\text{C}$  to  $85^{\circ}\text{C}$ . Parameters that can exhibit significant variance with regard to operating voltage or temperature are presented in the [Typical Characteristics](#).

### CAUTION

Supply voltages larger than 36 V can permanently damage the device; see the [Absolute Maximum Ratings](#).

Place 10-nF bypass capacitors close to the power-supply pins to reduce errors coupling in from noisy or high-impedance power supplies. For more detailed information on bypass capacitor placement, see the [Layout Guidelines](#).

## 10 Layout

### 10.1 Layout Guidelines

For best operational performance of the device, use good PCB layout practices, including:

- Noise can propagate into analog circuitry through the power pins of the circuit as a whole and operational amplifier itself. Bypass capacitors are used to reduce the coupled noise by providing low-impedance power sources local to the analog circuitry.
  - Connect low-ESR, 10-nF ceramic bypass capacitors between each supply pin and ground, placed as close to the device as possible. A single bypass capacitor from V+ to ground is applicable for single-supply applications.
- Separate grounding for analog and digital portions of circuitry is one of the simplest and most-effective methods of noise suppression. One or more layers on multilayer PCBs are usually devoted to ground planes. A ground plane helps distribute heat and reduces EMI noise pickup. Make sure to physically separate digital and analog grounds paying attention to the flow of the ground current. For more detailed information refer to [Circuit Board Layout Techniques](#), [SLOA089](#).
- In order to reduce parasitic coupling, run the input traces as far away from the supply or output traces as possible. If these traces cannot be kept separate, crossing the sensitive trace perpendicular is much better as opposed to in parallel with the noisy trace.
- Place the external components as close to the device as possible. As shown in [Layout Example](#), keeping RF and RG close to the inverting input minimizes parasitic capacitance.
- Keep the length of input traces as short as possible. Always remember that the input traces are the most sensitive part of the circuit.
- Consider a driven, low-impedance guard ring around the critical traces. A guard ring can significantly reduce leakage currents from nearby traces that are at different potentials.
- Cleaning the PCB following board assembly is recommended for best performance.
- Any precision integrated circuit may experience performance shifts due to moisture ingress into the plastic package. Following any aqueous PCB cleaning process, baking the PCB assembly is recommended to remove moisture introduced into the device packaging during the cleaning process. A low temperature, post cleaning bake at  $85^{\circ}\text{C}$  for 30 minutes is sufficient for most circumstances.

## 10.2 Layout Example

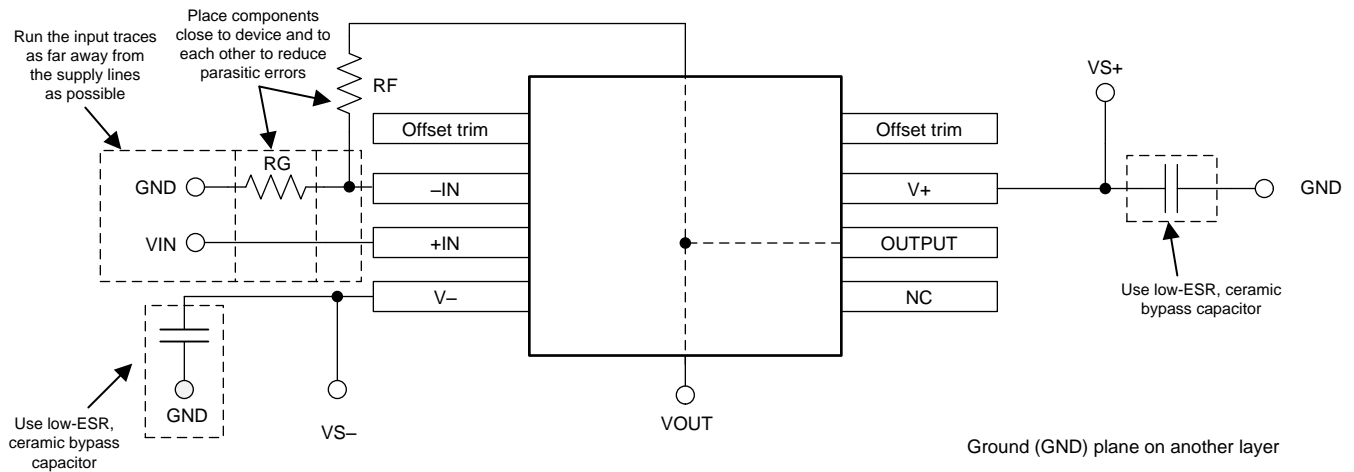
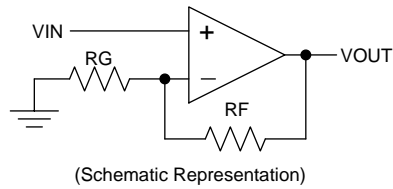

Figure 32. OPA134 Layout Example for the Noninverting Configuration

## 11 Device and Documentation Support

### 11.1 Device Support

#### 11.1.1 Development Support

##### 11.1.1.1 WEBENCH Filter Designer Tool

**WEBENCH® Filter Designer** is a simple, powerful, and easy-to-use active filter design program. The WEBENCH Filter Designer lets you create optimized filter designs using a selection of TI operational amplifiers and passive components from TI's vendor partners.

##### 11.1.1.2 TINA-TI™ (Free Software Download)

TINA™ is a simple, powerful, and easy-to-use circuit simulation program based on a SPICE engine. TINA-TI is a free, fully-functional version of the TINA software, preloaded with a library of macro models in addition to a range of both passive and active models. TINA-TI provides all the conventional dc, transient, and frequency domain analysis of SPICE, as well as additional design capabilities.

Available as a [free download](#) from the Analog eLab Design Center, TINA-TI offers extensive post-processing capability that allows users to format results in a variety of ways. Virtual instruments offer the ability to select input waveforms and probe circuit nodes, voltages, and waveforms, creating a dynamic quick-start tool.

#### NOTE

These files require that either the TINA software (from DesignSoft™) or TINA-TI software be installed. Download the free TINA-TI software from the [TINA-TI folder](#).

##### 11.1.1.3 TI Precision Designs

The OPAx134 is featured in several TI Precision Designs, available online at <http://www.ti.com/ww/en/analog/precision-designs/>. TI Precision Designs are analog solutions created by TI's precision analog applications experts and offer the theory of operation, component selection, simulation, complete PCB schematic and layout, bill of materials, and measured performance of many useful circuits.

### 11.2 Documentation Support

#### 11.2.1 Related Documentation

For related documentation, see the following:

- *EMI Rejection Ratio of Operational Amplifiers*, [SBOA128](#)
- *Circuit Board Layout Techniques*, [SLOA089](#)

### 11.3 Related Links

The table below lists quick access links. Categories include technical documents, support and community resources, tools and software, and quick access to sample or buy.

**Table 1. Related Links**

PARTS	PRODUCT FOLDER	SAMPLE & BUY	TECHNICAL DOCUMENTS	TOOLS & SOFTWARE	SUPPORT & COMMUNITY
OPA134	<a href="#">Click here</a>	<a href="#">Click here</a>	<a href="#">Click here</a>	<a href="#">Click here</a>	<a href="#">Click here</a>
OPA2134	<a href="#">Click here</a>	<a href="#">Click here</a>	<a href="#">Click here</a>	<a href="#">Click here</a>	<a href="#">Click here</a>
OPA4134	<a href="#">Click here</a>	<a href="#">Click here</a>	<a href="#">Click here</a>	<a href="#">Click here</a>	<a href="#">Click here</a>

## 11.4 Community Resources

The following links connect to TI community resources. Linked contents are provided "AS IS" by the respective contributors. They do not constitute TI specifications and do not necessarily reflect TI's views; see TI's [Terms of Use](#).

**TI E2E™ Online Community** *TI's Engineer-to-Engineer (E2E) Community*. Created to foster collaboration among engineers. At [e2e.ti.com](http://e2e.ti.com), you can ask questions, share knowledge, explore ideas and help solve problems with fellow engineers.

**Design Support** *TI's Design Support* Quickly find helpful E2E forums along with design support tools and contact information for technical support.

## 11.5 Trademarks

SoundPlus, TINA-TI, E2E are trademarks of Texas Instruments.  
TINA, DesignSoft are trademarks of DesignSoft, Inc.  
All other trademarks are the property of their respective owners.

## 11.6 Electrostatic Discharge Caution



These devices have limited built-in ESD protection. The leads should be shorted together or the device placed in conductive foam during storage or handling to prevent electrostatic damage to the MOS gates.

## 11.7 Glossary

[SLYZ022](#) — *TI Glossary*.

This glossary lists and explains terms, acronyms, and definitions.

## 12 Mechanical, Packaging, and Orderable Information

The following pages include mechanical, packaging, and orderable information. This information is the most current data available for the designated devices. This data is subject to change without notice and revision of this document. For browser-based versions of this data sheet, refer to the left-hand navigation.

**PACKAGING INFORMATION**

Orderable Device	Status (1)	Package Type	Package Drawing	Pins	Package Qty	Eco Plan (2)	Lead finish/ Ball material (6)	MSL Peak Temp (3)	Op Temp (°C)	Device Marking (4/5)	Samples
OPA134PA	ACTIVE	PDIP	P	8	50	RoHS & Green	NIPDAU	N / A for Pkg Type		OPA134PA	<a href="#">Samples</a>
OPA134UA	ACTIVE	SOIC	D	8	75	RoHS & Green	NIPDAU	Level-3-260C-168 HR	-40 to 85	OPA 134UA	<a href="#">Samples</a>
OPA134UA/2K5	ACTIVE	SOIC	D	8	2500	RoHS & Green	NIPDAU	Level-3-260C-168 HR	-40 to 85	OPA 134UA	<a href="#">Samples</a>
OPA2134PA	ACTIVE	PDIP	P	8	50	RoHS & Green	NIPDAU	N / A for Pkg Type	-40 to 85	OPA2134PA	<a href="#">Samples</a>
OPA2134PAG4	ACTIVE	PDIP	P	8	50	RoHS & Green	NIPDAU	N / A for Pkg Type	-40 to 85	OPA2134PA	<a href="#">Samples</a>
OPA2134UA	ACTIVE	SOIC	D	8	75	RoHS & Green	NIPDAU	Level-3-260C-168 HR	-40 to 85	OPA 2134UA	<a href="#">Samples</a>
OPA2134UA/2K5	ACTIVE	SOIC	D	8	2500	RoHS & Green	NIPDAU	Level-3-260C-168 HR	-40 to 85	OPA 2134UA	<a href="#">Samples</a>
OPA2134UA/2K5E4	LIFEBUY	SOIC	D	8	2500	RoHS & Green	NIPDAU	Level-3-260C-168 HR	-40 to 85	OPA 2134UA	
OPA2134UAE4	LIFEBUY	SOIC	D	8	75	RoHS & Green	NIPDAU	Level-3-260C-168 HR	-40 to 85	OPA 2134UA	
OPA2134UAG4	LIFEBUY	SOIC	D	8	75	RoHS & Green	NIPDAU	Level-3-260C-168 HR	-40 to 85	OPA 2134UA	
OPA4134UA	ACTIVE	SOIC	D	14	50	RoHS & Green	NIPDAU	Level-3-260C-168 HR	-40 to 85	OPA4134UA	<a href="#">Samples</a>
OPA4134UA/2K5	ACTIVE	SOIC	D	14	2500	RoHS & Green	NIPDAU	Level-3-260C-168 HR	-40 to 85	OPA4134UA	<a href="#">Samples</a>
OPA4134UAE4	LIFEBUY	SOIC	D	14	50	RoHS & Green	NIPDAU	Level-3-260C-168 HR	-40 to 85	OPA4134UA	
SN412008DRE4	ACTIVE	SOIC	D	8	2500	RoHS & Green	NIPDAU	Level-3-260C-168 HR	-40 to 85	OPA 2134UA	<a href="#">Samples</a>

(1) The marketing status values are defined as follows:

**ACTIVE:** Product device recommended for new designs.

**LIFEBUY:** TI has announced that the device will be discontinued, and a lifetime-buy period is in effect.

**NRND:** Not recommended for new designs. Device is in production to support existing customers, but TI does not recommend using this part in a new design.

**PREVIEW:** Device has been announced but is not in production. Samples may or may not be available.

**OBSELETE:** TI has discontinued the production of the device.

(2) **RoHS:** TI defines "RoHS" to mean semiconductor products that are compliant with the current EU RoHS requirements for all 10 RoHS substances, including the requirement that RoHS substance do not exceed 0.1% by weight in homogeneous materials. Where designed to be soldered at high temperatures, "RoHS" products are suitable for use in specified lead-free processes. TI may reference these types of products as "Pb-Free".

**RoHS Exempt:** TI defines "RoHS Exempt" to mean products that contain lead but are compliant with EU RoHS pursuant to a specific EU RoHS exemption.

**Green:** TI defines "Green" to mean the content of Chlorine (Cl) and Bromine (Br) based flame retardants meet JS709B low halogen requirements of  $\leq 1000$ ppm threshold. Antimony trioxide based flame retardants must also meet the  $\leq 1000$ ppm threshold requirement.

(3) MSL, Peak Temp. - The Moisture Sensitivity Level rating according to the JEDEC industry standard classifications, and peak solder temperature.

(4) There may be additional marking, which relates to the logo, the lot trace code information, or the environmental category on the device.

(5) Multiple Device Markings will be inside parentheses. Only one Device Marking contained in parentheses and separated by a "~" will appear on a device. If a line is indented then it is a continuation of the previous line and the two combined represent the entire Device Marking for that device.

(6) Lead finish/Ball material - Orderable Devices may have multiple material finish options. Finish options are separated by a vertical ruled line. Lead finish/Ball material values may wrap to two lines if the finish value exceeds the maximum column width.

**Important Information and Disclaimer:** The information provided on this page represents TI's knowledge and belief as of the date that it is provided. TI bases its knowledge and belief on information provided by third parties, and makes no representation or warranty as to the accuracy of such information. Efforts are underway to better integrate information from third parties. TI has taken and continues to take reasonable steps to provide representative and accurate information but may not have conducted destructive testing or chemical analysis on incoming materials and chemicals. TI and TI suppliers consider certain information to be proprietary, and thus CAS numbers and other limited information may not be available for release.

In no event shall TI's liability arising out of such information exceed the total purchase price of the TI part(s) at issue in this document sold by TI to Customer on an annual basis.

## TAPE AND REEL INFORMATION



### QUADRANT ASSIGNMENTS FOR PIN 1 ORIENTATION IN TAPE



\*All dimensions are nominal

Device	Package Type	Package Drawing	Pins	SPQ	Reel Diameter (mm)	Reel Width W1 (mm)	A0 (mm)	B0 (mm)	K0 (mm)	P1 (mm)	W (mm)	Pin1 Quadrant
OPA134UA/2K5	SOIC	D	8	2500	330.0	12.4	6.4	5.2	2.1	8.0	12.0	Q1
OPA2134UA/2K5	SOIC	D	8	2500	330.0	12.4	6.4	5.2	2.1	8.0	12.0	Q1
OPA4134UA/2K5	SOIC	D	14	2500	330.0	16.4	6.5	9.0	2.1	8.0	16.0	Q1

## TAPE AND REEL BOX DIMENSIONS

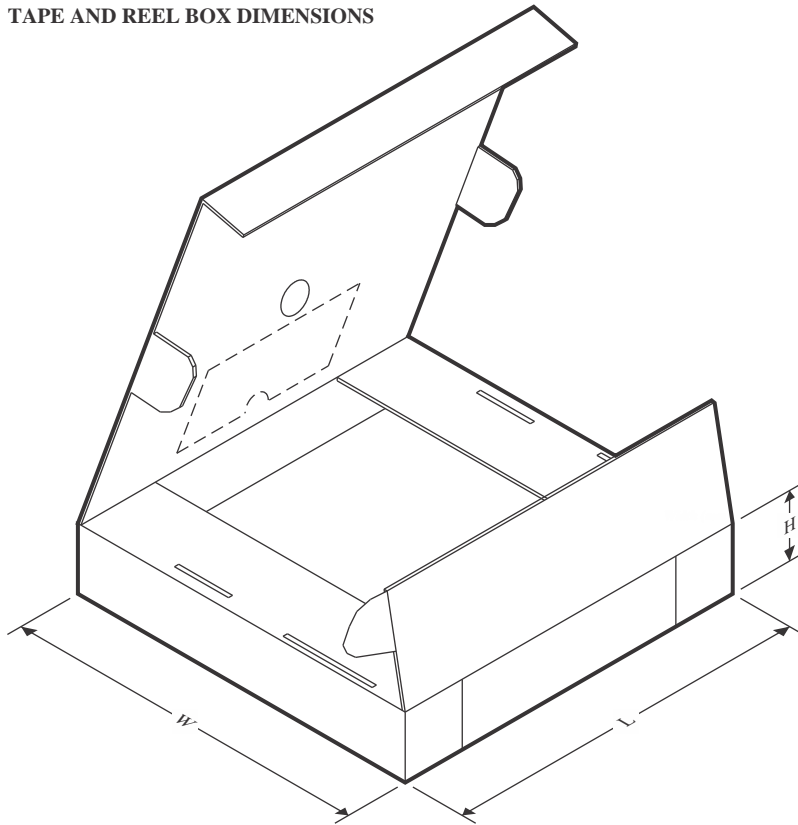

\*All dimensions are nominal

Device	Package Type	Package Drawing	Pins	SPQ	Length (mm)	Width (mm)	Height (mm)
OPA134UA/2K5	SOIC	D	8	2500	356.0	356.0	35.0
OPA2134UA/2K5	SOIC	D	8	2500	356.0	356.0	35.0
OPA4134UA/2K5	SOIC	D	14	2500	356.0	356.0	35.0

**TUBE**

\*All dimensions are nominal

Device	Package Name	Package Type	Pins	SPQ	L (mm)	W (mm)	T (μm)	B (mm)
OPA134PA	P	PDIP	8	50	506	13.97	11230	4.32
OPA134UA	D	SOIC	8	75	506.6	8	3940	4.32
OPA2134PA	P	PDIP	8	50	506	13.97	11230	4.32
OPA2134PAG4	P	PDIP	8	50	506	13.97	11230	4.32
OPA2134UA	D	SOIC	8	75	506.6	8	3940	4.32
OPA2134UAE4	D	SOIC	8	75	506.6	8	3940	4.32
OPA2134UAG4	D	SOIC	8	75	506.6	8	3940	4.32
OPA4134UA	D	SOIC	14	50	506.6	8	3940	4.32
OPA4134UAE4	D	SOIC	14	50	506.6	8	3940	4.32

D (R-PDSO-G14)

PLASTIC SMALL OUTLINE

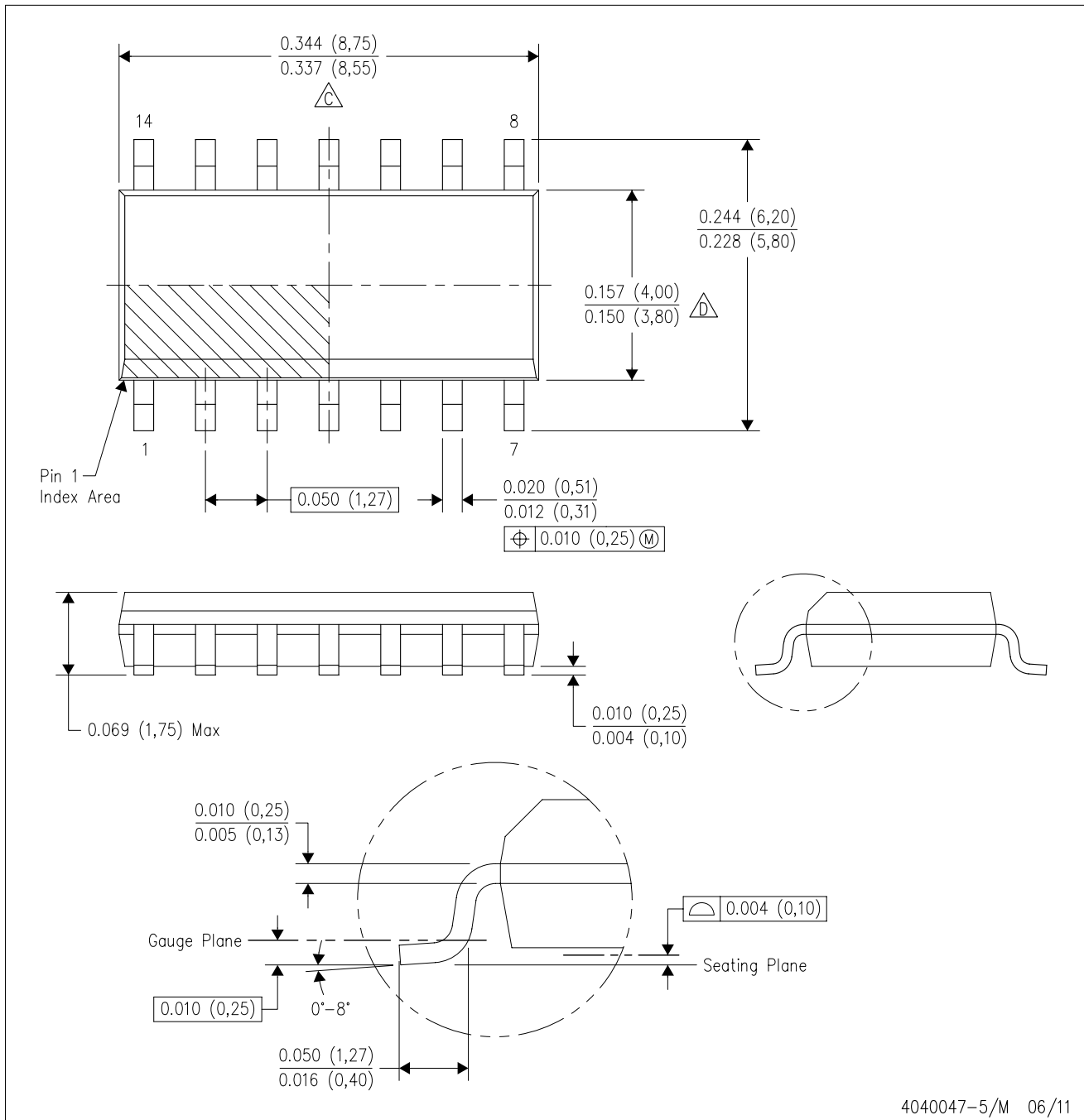

- NOTES:
- A. All linear dimensions are in inches (millimeters).
  - B. This drawing is subject to change without notice.
  -  Body length does not include mold flash, protrusions, or gate burrs. Mold flash, protrusions, or gate burrs shall not exceed 0.006 (0,15) each side.
  -  Body width does not include interlead flash. Interlead flash shall not exceed 0.017 (0,43) each side.
  - E. Reference JEDEC MS-012 variation AB.

D (R-PDSO-G14)

PLASTIC SMALL OUTLINE



- NOTES:
- A. All linear dimensions are in millimeters.
  - B. This drawing is subject to change without notice.
  - C. Publication IPC-7351 is recommended for alternate designs.
  - D. Laser cutting apertures with trapezoidal walls and also rounding corners will offer better paste release. Customers should contact their board assembly site for stencil design recommendations. Refer to IPC-7525 for other stencil recommendations.
  - E. Customers should contact their board fabrication site for solder mask tolerances between and around signal pads.



D0008A

# PACKAGE OUTLINE

SOIC - 1.75 mm max height

SMALL OUTLINE INTEGRATED CIRCUIT



4214825/C 02/2019

### NOTES:

1. Linear dimensions are in inches [millimeters]. Dimensions in parenthesis are for reference only. Controlling dimensions are in inches. Dimensioning and tolerancing per ASME Y14.5M.
2. This drawing is subject to change without notice.
3. This dimension does not include mold flash, protrusions, or gate burrs. Mold flash, protrusions, or gate burrs shall not exceed  $.006$  [0.15] per side.
4. This dimension does not include interlead flash.
5. Reference JEDEC registration MS-012, variation AA.

# EXAMPLE BOARD LAYOUT

D0008A

SOIC - 1.75 mm max height

SMALL OUTLINE INTEGRATED CIRCUIT



LAND PATTERN EXAMPLE  
 EXPOSED METAL SHOWN  
 SCALE:8X



SOLDER MASK DETAILS

4214825/C 02/2019

NOTES: (continued)

- 6. Publication IPC-7351 may have alternate designs.
- 7. Solder mask tolerances between and around signal pads can vary based on board fabrication site.

# EXAMPLE STENCIL DESIGN

D0008A

SOIC - 1.75 mm max height

SMALL OUTLINE INTEGRATED CIRCUIT



SOLDER PASTE EXAMPLE  
BASED ON .005 INCH [0.125 MM] THICK STENCIL  
SCALE:8X

4214825/C 02/2019

NOTES: (continued)

8. Laser cutting apertures with trapezoidal walls and rounded corners may offer better paste release. IPC-7525 may have alternate design recommendations.
9. Board assembly site may have different recommendations for stencil design.

P (R-PDIP-T8)

PLASTIC DUAL-IN-LINE PACKAGE

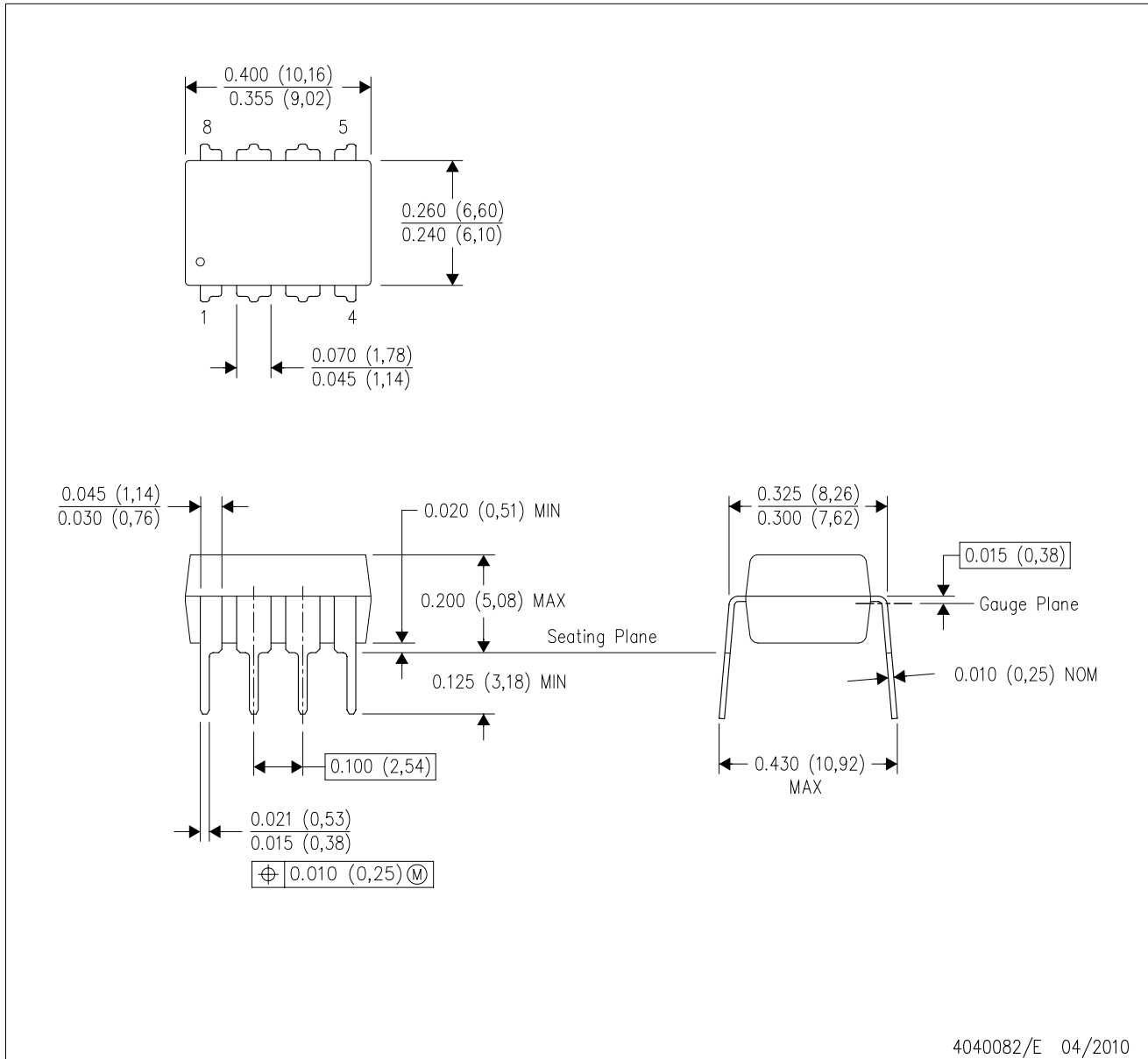

- NOTES:
- A. All linear dimensions are in inches (millimeters).
  - B. This drawing is subject to change without notice.
  - C. Falls within JEDEC MS-001 variation BA.

## IMPORTANT NOTICE AND DISCLAIMER

TI PROVIDES TECHNICAL AND RELIABILITY DATA (INCLUDING DATA SHEETS), DESIGN RESOURCES (INCLUDING REFERENCE DESIGNS), APPLICATION OR OTHER DESIGN ADVICE, WEB TOOLS, SAFETY INFORMATION, AND OTHER RESOURCES "AS IS" AND WITH ALL FAULTS, AND DISCLAIMS ALL WARRANTIES, EXPRESS AND IMPLIED, INCLUDING WITHOUT LIMITATION ANY IMPLIED WARRANTIES OF MERCHANTABILITY, FITNESS FOR A PARTICULAR PURPOSE OR NON-INFRINGEMENT OF THIRD PARTY INTELLECTUAL PROPERTY RIGHTS.

These resources are intended for skilled developers designing with TI products. You are solely responsible for (1) selecting the appropriate TI products for your application, (2) designing, validating and testing your application, and (3) ensuring your application meets applicable standards, and any other safety, security, regulatory or other requirements.

These resources are subject to change without notice. TI grants you permission to use these resources only for development of an application that uses the TI products described in the resource. Other reproduction and display of these resources is prohibited. No license is granted to any other TI intellectual property right or to any third party intellectual property right. TI disclaims responsibility for, and you will fully indemnify TI and its representatives against, any claims, damages, costs, losses, and liabilities arising out of your use of these resources.

TI's products are provided subject to [TI's Terms of Sale](#) or other applicable terms available either on [ti.com](https://www.ti.com) or provided in conjunction with such TI products. TI's provision of these resources does not expand or otherwise alter TI's applicable warranties or warranty disclaimers for TI products.

TI objects to and rejects any additional or different terms you may have proposed.

Mailing Address: Texas Instruments, Post Office Box 655303, Dallas, Texas 75265  
Copyright © 2024, Texas Instruments Incorporated

## Looking for pricing, stock, or lifecycle information?

Click below to explore more details on WIN SOURCE:

 [View OPA2134UA/2K5 on WIN SOURCE](#)

 [Texas Instruments](#) Information

## Optimize Your Supply Chain with WIN SOURCE Solutions

-  Global Sourcing Solution
-  Obsolete Management
-  Cost Control Management
-  Shortage Management
-  Alternative Solution
-  Excess Inventory Management