



THE DATASHEET OF OPA340PA



OPAx340 Single-Supply, Rail-to-Rail Operational Amplifiers

MicroAmplifier™ Series

1 Features

- Rail-to-Rail Input
- Rail-to-Rail Output (Within 1 mV)
- *MicroSize* Packages
- Wide Bandwidth: 5.5 MHz
- High Slew Rate: 6 V/μs
- Low THD + Noise: 0.0007% (f = 1 kHz)
- Low Quiescent Current: 750 μA/Channel
- Single, Dual, and Quad Versions

2 Applications

- Driving A/D Converters
- PCMCIA Cards
- Data Acquisition
- Process Control
- Audio Processing
- Communications
- Active Filters
- Test Equipment

3 Description

The OPA340 series rail-to-rail CMOS operational amplifiers are optimized for low-voltage, single-supply operation. Rail-to-rail input and output and high-speed operation make them ideal for driving sampling analog-to-digital (A/D) converters. They are also well-suited for general purpose and audio applications as well as providing I/V conversion at the output of digital-to-analog (D/A) converters. Single, dual, and quad versions have identical specifications for design flexibility.

The OPA340 series operate on a single supply as low as 2.5 V with an input common-mode voltage range that extends 500 mV below ground and 500 mV above the positive supply. Output voltage swing is to within 1 mV of the supply rails with a 100-kΩ load. These devices offer excellent dynamic response (BW = 5.5 MHz, SR = 6 V/μs), yet quiescent current is only 750 A. Dual and quad designs feature completely independent circuitry for lowest crosstalk and freedom from interaction.

The single (OPA340) packages are the tiny 5-pin SOT-23 surface mount, 8-pin SOIC surface mount, and 8-pin DIP. The dual (OPA2340) comes in the miniature 8-pin VSSOP surface mount, 8-pin SOIC surface mount, and 8-pin PDIP packages. The quad (OPA4340) packages are the space-saving 16-pin SSOP surface mount and 14-pin SOIC surface mount. All are specified from –40°C to 85°C and operate from –55°C to 125°C. A SPICE macromodel is available for design analysis.

Device Information⁽¹⁾

PART NUMBER	PACKAGE	BODY SIZE (NOM)
OPA340	SOT-23 (5)	3.00 mm × 3.00 mm
OPA340, OPA2340	PDIP (8)	9.81 mm × 6.35 mm
	SOIC (8)	4.90 mm × 3.91 mm
OPA2340	VSSOP (8)	3.00 mm × 3.00 mm
OPA4340	SOIC (14)	8.65 mm × 3.91 mm
	SSOP (16)	4.90 mm × 3.90 mm

(1) For all available packages, see the orderable addendum at the end of the data sheet.

OPA340 in Noninverting Configuration Driving ADS7816



Copyright © 2016, Texas Instruments Incorporated



Table of Contents

1 Features	1	7.4 Device Functional Modes.....	15
2 Applications	1	8 Application and Implementation	16
3 Description	1	8.1 Application Information.....	16
4 Revision History	2	8.2 Typical Applications	16
5 Pin Configuration and Functions	3	9 Power Supply Recommendations	19
6 Specifications	5	10 Layout	20
6.1 Absolute Maximum Ratings	5	10.1 Layout Guidelines	20
6.2 ESD Ratings	5	10.2 Layout Example	20
6.3 Recommended Operating Conditions.....	5	11 Device and Documentation Support	21
6.4 Thermal Information – OPA340	5	11.1 Device Support.....	21
6.5 Thermal Information – OPA2340	6	11.2 Documentation Support	22
6.6 Thermal Information – OPA4340	6	11.3 Related Links	22
6.7 Electrical Characteristics.....	6	11.4 Receiving Notification of Documentation Updates	22
6.8 Typical Characteristics.....	8	11.5 Community Resources.....	22
7 Detailed Description	12	11.6 Trademarks	22
7.1 Overview	12	11.7 Electrostatic Discharge Caution.....	22
7.2 Functional Block Diagram	12	11.8 Glossary	23
7.3 Feature Description.....	13	12 Mechanical, Packaging, and Orderable Information	23

4 Revision History

Changes from Revision B (November 2007) to Revision C

Page

- Added *ESD Ratings* table, *Feature Description* section, *Device Functional Modes*, *Application and Implementation* section, *Power Supply Recommendations* section, *Layout* section, *Device and Documentation Support* section, and *Mechanical, Packaging, and Orderable Information* section. **1**
- Deleted *Package/Ordering Information* table, see POA at the end of the data sheet..... **1**

5 Pin Configuration and Functions

**OPA340: DBV Package
5-Pin SOT-23
Top View**



**OPA340: P and D Packages
8-Pin PDIP and SOIC
Top View**

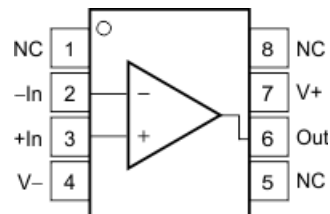

Pin Functions: OPA340

NAME	PIN		I/O	DESCRIPTION
	SOT-23	SOIC, PDIP		
-IN	4	2	I	Negative (inverting) input
+IN	3	3	I	Positive (noninverting) input
NC	—	1, 5, 8	—	No internal connection (can be left floating)
OUT	1	6	O	Output
V-	2	4	—	Negative (lowest) power supply
V+	5	7	—	Positive (highest) power supply

**OPA2340: P, D, and DGK Packages
8-Pin PDIP, SOIC, and VSSOP
Top View**



Pin Functions: OPA2340

NAME	PIN		I/O	DESCRIPTION
	VSSOP, SOIC, PDIP			
-IN A	2		I	Negative (inverting) input channel A
+IN A	3		I	Positive (noninverting) input channel A
-IN B	6		I	Negative (inverting) input channel B
+IN B	5		I	Positive (noninverting) input channel B
OUT A	1		O	Output channel A
OUT B	7		O	Output channel B
V-	4		—	Negative (lowest) power supply
V+	8		—	Positive (highest) power supply

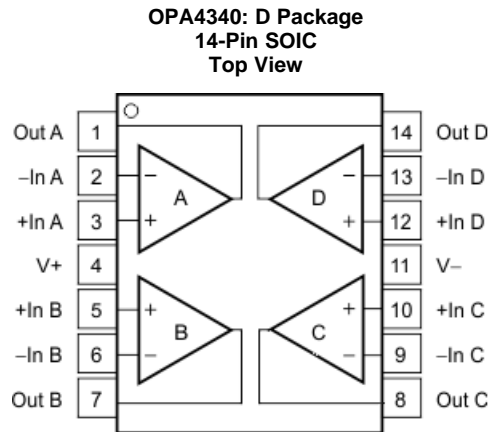

Pin Functions: OPA4340

NAME	PIN		I/O	DESCRIPTION
	SOIC	SSOP		
-IN A	2	2	I	Negative (inverting) input channel A
-IN B	6	6	I	Negative (inverting) input channel B
-IN C	9	11	I	Negative (inverting) input channel C
-IN D	13	15	I	Negative (inverting) input channel D
+IN A	3	3	I	Positive (noninverting) input channel A
+IN B	5	5	I	Positive (noninverting) input channel B
+IN C	10	12	I	Positive (noninverting) input channel C
+IN D	12	14	I	Positive (noninverting) input channel D
NC	—	8, 9	—	No internal connection (can be left floating)
OUT A	1	1	O	Output, channel A
OUT B	7	7	O	Output, channel B
OUT C	8	10	O	Output, channel C
OUT D	14	16	O	Output, channel D
V-	11	13	—	Negative (lowest) power supply
V+	4	4	—	Positive (highest) power supply

6 Specifications

6.1 Absolute Maximum Ratings

over operating free-air temperature range (unless otherwise noted)⁽¹⁾

		MIN	MAX	UNIT
Voltage	Supply voltage		5.5	V
	Signal input terminals ⁽²⁾	–0.5	0.5	
Current	Signal input terminals ⁽²⁾		10	mA
	Output short circuit ⁽³⁾	Continuous		
Temperature	Operating, T _A	–55	125	°C
	Junction, T _J		150	
	Storage, T _{stg}	–55	125	

- Stresses beyond those listed under *Absolute Maximum Ratings* may cause permanent damage to the device. These are stress ratings only, which do not imply functional operation of the device at these or any other conditions beyond those indicated under *Recommended Operating Conditions*. Exposure to absolute-maximum-rated conditions for extended periods may affect device reliability.
- Input terminals are diode-clamped to the power-supply rails. Input signals that can swing more than 0.5 V beyond the supply rails should be current limited to 10 mA or less.
- Short-circuit to ground, one amplifier per package.

6.2 ESD Ratings

		VALUE	UNIT
V _(ESD)	Electrostatic discharge	Human-body model (HBM), per ANSI/ESDA/JEDEC JS-001 ⁽¹⁾	±600
		Charged-device model (CDM), per JEDEC specification JESD22-C101 ⁽²⁾	±250

- JEDEC document JEP155 states that 500-V HBM allows safe manufacturing with a standard ESD control process.
- JEDEC document JEP157 states that 250-V CDM allows safe manufacturing with a standard ESD control process.

6.3 Recommended Operating Conditions

over operating free-air temperature range (unless otherwise noted)

	MIN	MAX	UNIT
Supply voltage	2.7	5.5	V
Specified temperature	–40	125	°C

6.4 Thermal Information – OPA340

THERMAL METRIC ⁽¹⁾	OPA340				UNIT	
	DBV (SOT-23)	P (PDIP)	D (SOIC)	D (SOIC)		
	5 PINS	8 PINS	8 PINS	14 PINS		
R _{θJA}	Junction-to-ambient thermal resistance	207.9	53.1	142	83.8	°C/W
R _{θJC(top)}	Junction-to-case (top) thermal resistance	71.2	42.5	90.2	70.7	°C/W
R _{θJB}	Junction-to-board thermal resistance	36.0	30.3	82.5	59.5	°C/W
ψ _{JT}	Junction-to-top characterization parameter	2.0	19.7	39.4	11.6	°C/W
ψ _{JB}	Junction-to-board characterization parameter	35.2	30.2	82	37.7	°C/W
R _{θJC(bot)}	Junction-to-case (bottom) thermal resistance	—	—	—	—	°C/W

- For more information about traditional and new thermal metrics, see the *Semiconductor and IC Package Thermal Metrics* application report.

6.5 Thermal Information – OPA2340

THERMAL METRIC ⁽¹⁾		OPA2340		UNIT
		D (SOIC)	DGK (VSSOP)	
		8 PINS	8 PINS	
R _{θJA}	Junction-to-ambient thermal resistance	138.4	169.2	°C/W
R _{θJC(top)}	Junction-to-case (top) thermal resistance	89.5	62.8	°C/W
R _{θJB}	Junction-to-board thermal resistance	78.6	89.8	°C/W
ψ _{JT}	Junction-to-top characterization parameter	29.9	7.5	°C/W
ψ _{JB}	Junction-to-board characterization parameter	78.1	88.2	°C/W
R _{θJC(bot)}	Junction-to-case (bottom) thermal resistance	—	—	°C/W

(1) For more information about traditional and new thermal metrics, see the [Semiconductor and IC Package Thermal Metrics](#) application report.

6.6 Thermal Information – OPA4340

THERMAL METRIC ⁽¹⁾		OPA4340		UNIT
		DBQ (SSOP)		
		16 PINS		
R _{θJA}	Junction-to-ambient thermal resistance	115.8		°C/W
R _{θJC(top)}	Junction-to-case (top) thermal resistance	67		°C/W
R _{θJB}	Junction-to-board thermal resistance	58.3		°C/W
ψ _{JT}	Junction-to-top characterization parameter	19.9		°C/W
ψ _{JB}	Junction-to-board characterization parameter	57.9		°C/W
R _{θJC(bot)}	Junction-to-case (bottom) thermal resistance	—		°C/W

(1) For more information about traditional and new thermal metrics, see the [Semiconductor and IC Package Thermal Metrics](#) application report.

6.7 Electrical Characteristics

At T_A = 25°C, R_L = 10 kΩ connected to V_S/2, and V_{OUT} = V_S/2, unless otherwise noted.

PARAMETER		TEST CONDITIONS	MIN	TYP ⁽¹⁾	MAX	UNIT
OFFSET VOLTAGE						
V _{OS}	Input offset voltage	V _S = 5 V		±150	±500	μV
dV _{OS} /dt	Input offset voltage vs temperature	T _A = –40°C to 85°C, V _S = 5 V		±2.5		μV/°C
PSRR	Input offset voltage vs power supply	V _S = 2.7 V to 5.5 V, V _{CM} = 0 V		30	120	μV/V
		Over temperature V _S = 2.7 V to 5.5 V, V _{CM} = 0 V, T _A = –40°C to 85°C, V _S = 5 V			120	μV/°C
Channel separation, DC				0.2		μV/V
INPUT BIAS CURRENT						
I _S	Input bias current			±0.2	±10	pA
		Over temperature T _A = –40°C to 85°C, V _S = 5 V			±60	
I _{OS}	Input offset current			±0.2	±10	pA
NOISE						
Input voltage noise		f = 0.1 kHz to 50 kHz		8		μV _{RMS}
e _n	Input voltage noise density	f = 1 kHz		25		nV/√Hz
i _n	Current noise density	f = 1 kHz		3		fA/√Hz
INPUT VOLTAGE RANGE						
V _{CM}	Common-mode voltage range		–0.3		(V+) + 0.3	V
CMRR	Common-mode rejection ratio	–0.3 V < V _{CM} < (V+) – 1.8 V	80	92		dB
		V _S = 5 V, –0.3 V < V _{CM} < 5.3 V	70	84		
		V _S = 2.7 V, –0.3 V < V _{CM} < 3 V	66	80		

(1) V_S = 5 V.

Electrical Characteristics (continued)

At $T_A = 25^\circ\text{C}$, $R_L = 10\text{ k}\Omega$ connected to $V_S/2$, and $V_{OUT} = V_S/2$, unless otherwise noted.

PARAMETER		TEST CONDITIONS	MIN	TYP ⁽¹⁾	MAX	UNIT	
INPUT IMPEDANCE							
Differential				$10^{13} \parallel 3$		$\Omega \parallel \text{pF}$	
Common-mode				$10^{13} \parallel 6$		$\Omega \parallel \text{pF}$	
OPEN-LOOP GAIN							
A_{OL}	Open-loop voltage gain	$R_L = 100\text{ k}\Omega$, $5\text{ mV} < V_O < (V+) - 5\text{ mV}$	106	124		dB	
		$R_L = 10\text{ k}\Omega$, $5\text{ mV} < V_O < (V+) - 50\text{ mV}$	100	120			
		$R_L = 2\text{ k}\Omega$, $200\text{ mV} < V_O < (V+) - 200\text{ mV}$	94	114			
		Over temperature	$R_L = 100\text{ k}\Omega$, $5\text{ mV} < V_O < (V+) - 5\text{ mV}$, $T_A = -40^\circ\text{C}$ to 85°C , $V_S = 5\text{ V}$	106			
			$R_L = 10\text{ k}\Omega$, $5\text{ mV} < V_O < (V+) - 50\text{ mV}$, $T_A = -40^\circ\text{C}$ to 85°C , $V_S = 5\text{ V}$	100			
			$R_L = 2\text{ k}\Omega$, $200\text{ mV} < V_O < (V+) - 200\text{ mV}$, $T_A = -40^\circ\text{C}$ to 85°C , $V_S = 5\text{ V}$	94			
FREQUENCY RESPONSE							
GBW	Gain-bandwidth product	$G = 1$		5.5		MHz	
SR	Slew rate	$V_S = 5\text{ V}$, $G = 1$, $C_L = 100\text{ pF}$		6		V/ μs	
	Settling time, 0.1%	$V_S = 5\text{ V}$, 2-V step, $C_L = 100\text{ pF}$		1		μs	
	Settling time, 0.01%	$V_S = 5\text{ V}$, 2-V step, $C_L = 100\text{ pF}$		1.6		μs	
	Overload recovery time	$V_{IN} \times G = V_S$		0.2		μs	
THD+N	Total harmonic distortion + noise	$V_S = 5\text{ V}$, $V_O = 3V_{PP}^{(2)}$, $G = 1$, $f = 1\text{ kHz}$		0.0007%			
OUTPUT							
Voltage output swing from rail ⁽²⁾		$R_L = 100\text{ k}\Omega$, $A_{OL} \geq 106\text{ dB}$		1	5	mV	
		$R_L = 10\text{ k}\Omega$, $A_{OL} \geq 106\text{ dB}$		10			
		$R_L = 2\text{ k}\Omega$, $A_{OL} \geq 106\text{ dB}$		40			
		Over temperature	$R_L = 100\text{ k}\Omega$, $A_{OL} \geq 106\text{ dB}$, $T_A = -40^\circ\text{C}$ to 85°C , $V_S = 5\text{ V}$		5		
			$R_L = 10\text{ k}\Omega$, $A_{OL} \geq 106\text{ dB}$, $T_A = -40^\circ\text{C}$ to 85°C , $V_S = 5\text{ V}$		50		
			$R_L = 2\text{ k}\Omega$, $A_{OL} \geq 106\text{ dB}$, $T_A = -40^\circ\text{C}$ to 85°C , $V_S = 5\text{ V}$		200		
I_{SC}	Short-circuit current			± 50		mA	
C_{LOAD}	Capacitive load drive			See Typical Characteristics			
POWER SUPPLY							
V_S	Specified voltage range			2.7	5	V	
	Operating voltage range	Lower end		2.5		V	
		Higher end		5.5			
I_Q	Quiescent current (per amplifier)	$I_O = 0$, $V_S = 5\text{ V}$		750	950	μA	
		Over temperature $I_O = 0$, $V_S = 5\text{ V}$, $T_A = -40^\circ\text{C}$ to 85°C			100		
TEMPERATURE RANGE							
	Specified range			-40	85	$^\circ\text{C}$	
	Operating range			-55	125	$^\circ\text{C}$	
	Storage range			-55	125	$^\circ\text{C}$	

(2) Output voltage swings are measured between the output and power-supply rails.

6.8 Typical Characteristics

At $T_A = 25^\circ\text{C}$, $V_S = 5\text{ V}$, and $R_L = 10\text{ k}\Omega$ connected to $V_S/2$, unless otherwise noted.

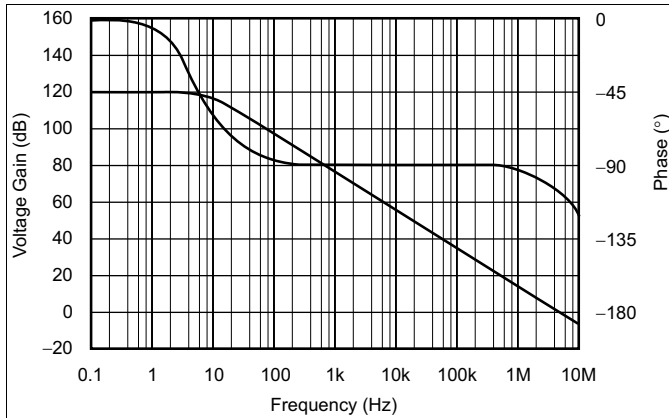

Figure 1. Open-Loop Gain/Phase vs Frequency

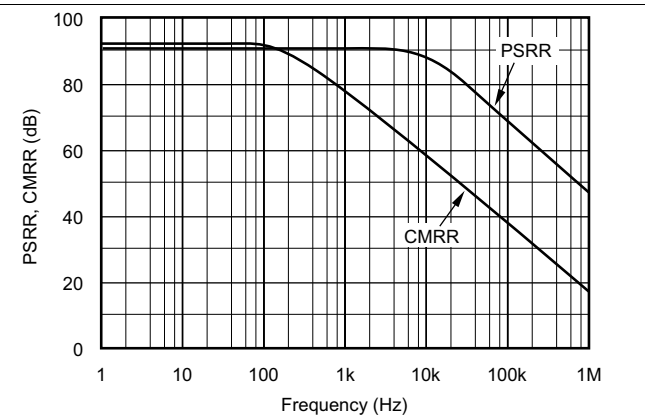

Figure 2. Power-Supply and Common-Mode Rejection vs Frequency

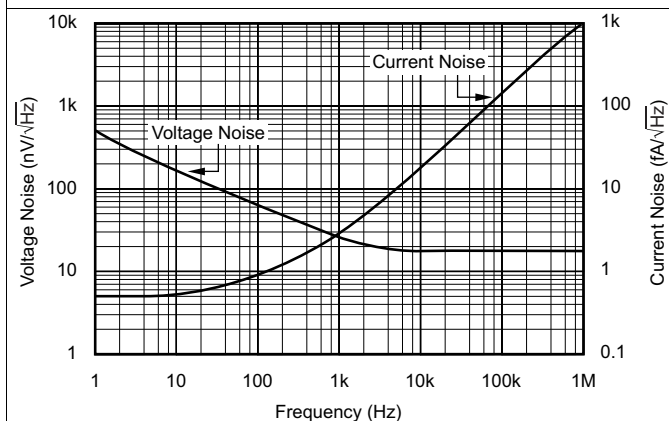

Figure 3. Input Voltage and Current Noise Spectral Density vs Frequency

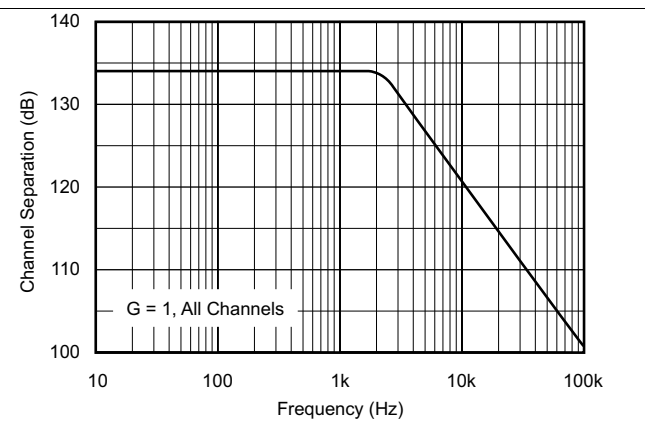

Figure 4. Channel Separation vs Frequency

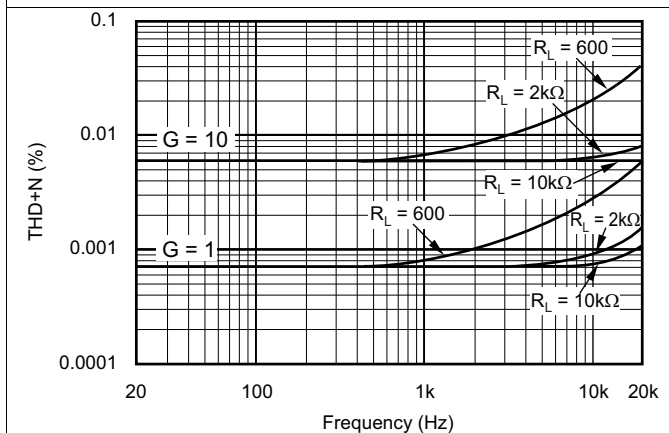

Figure 5. Total Harmonic Distortion + Noise vs Frequency

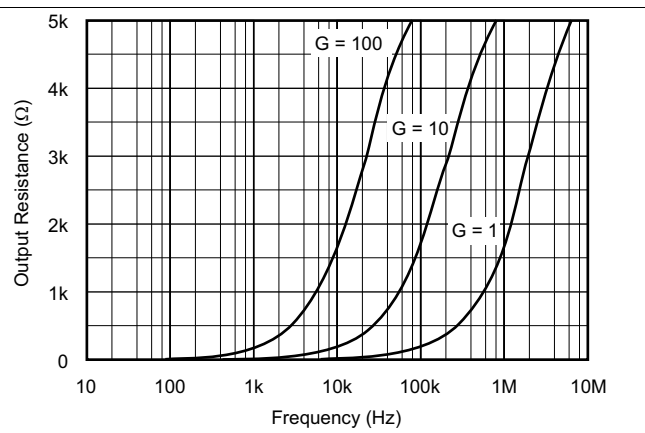

Figure 6. Closed-Loop Output Impedance vs Frequency

Typical Characteristics (continued)

At $T_A = 25^\circ\text{C}$, $V_S = 5\text{ V}$, and $R_L = 10\text{ k}\Omega$ connected to $V_S/2$, unless otherwise noted.

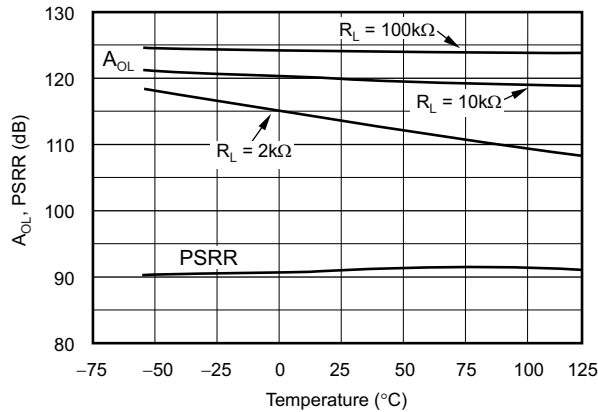

Figure 7. Open-Loop Gain and Power-Supply Rejection vs Temperature

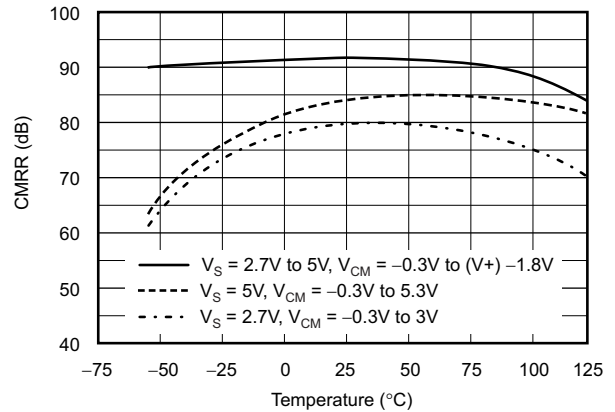

Figure 8. Common-Mode Rejection vs Temperature

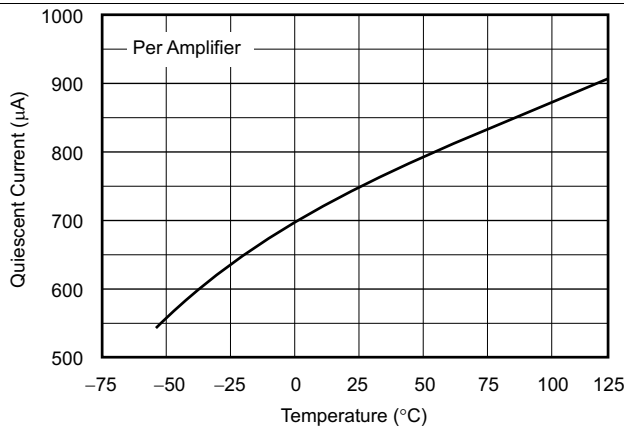

Figure 9. Quiescent Current vs Temperature

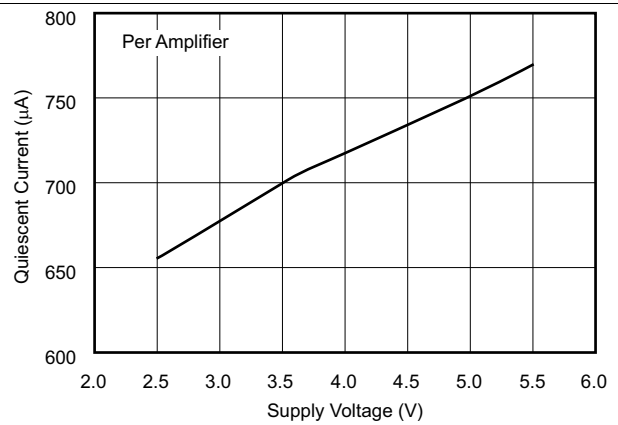

Figure 10. Quiescent Current vs Supply Voltage

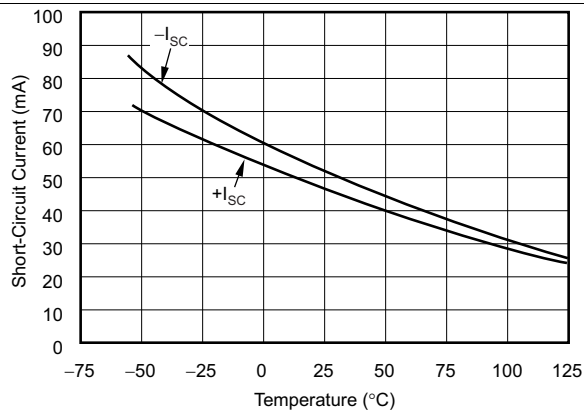

Figure 11. Short-Circuit Current vs Temperature

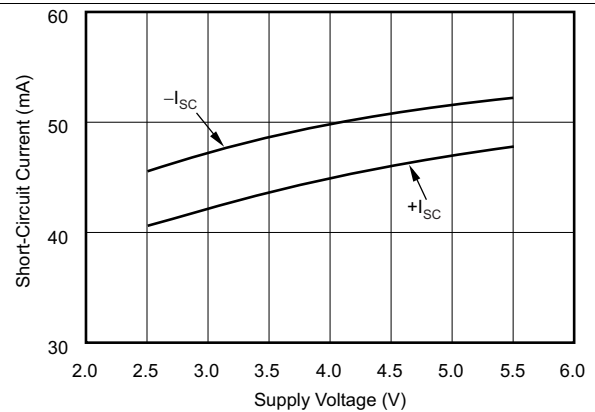

Figure 12. Short-Circuit Current vs Supply Voltage

Typical Characteristics (continued)

At $T_A = 25^\circ\text{C}$, $V_S = 5\text{ V}$, and $R_L = 10\text{ k}\Omega$ connected to $V_S/2$, unless otherwise noted.

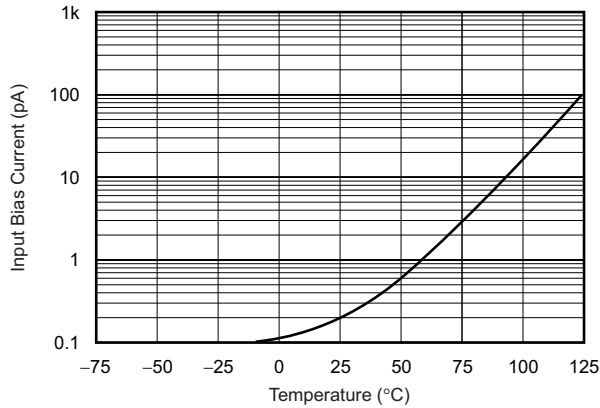

Figure 13. Input Bias Current vs Temperature

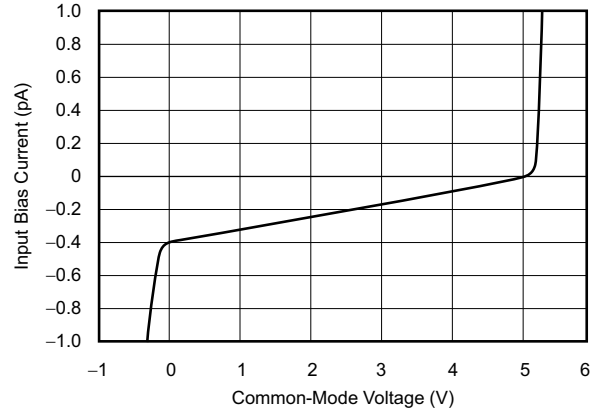

Figure 14. Input Bias Current vs Input Common-Mode Voltage

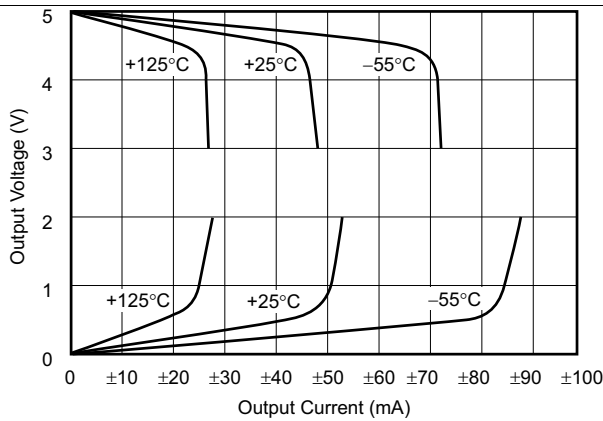

Figure 15. Output Voltage Swing vs Output Current

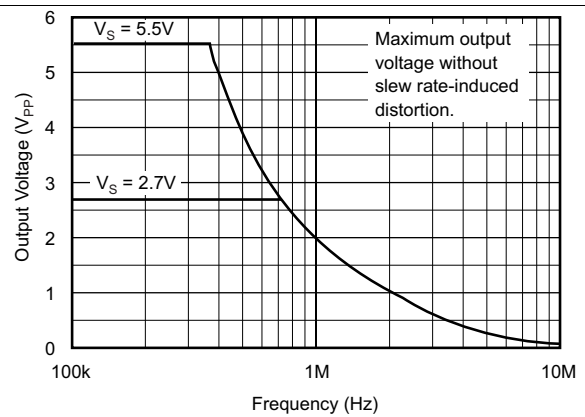

Figure 16. Maximum Output Voltage vs Frequency

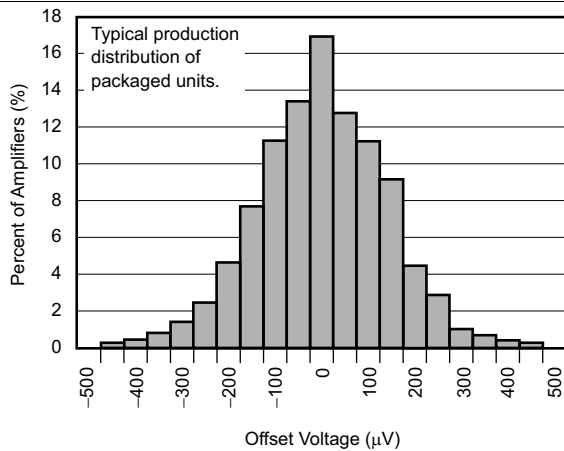

Figure 17. Offset Voltage Production Distribution

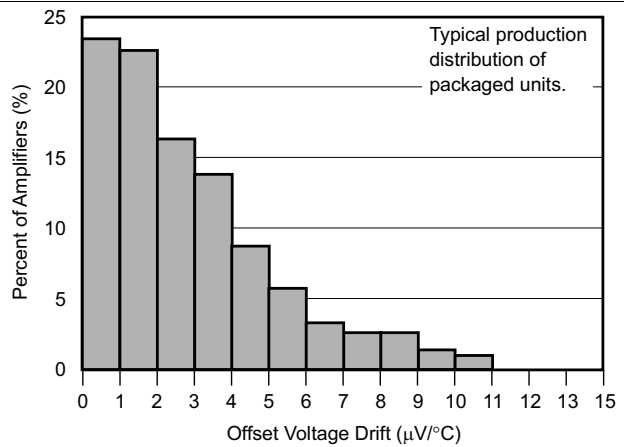
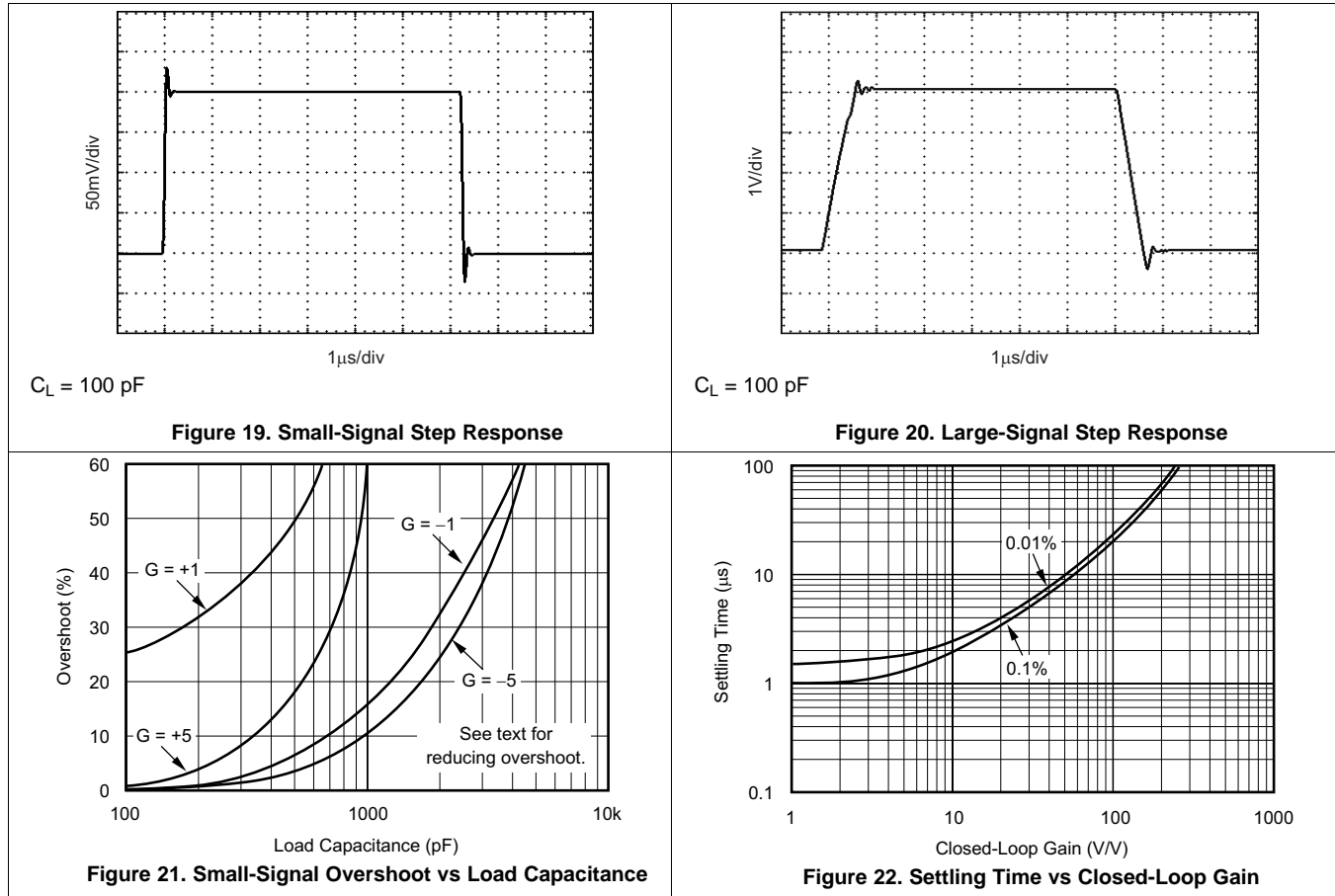

Figure 18. Offset Voltage Drift Magnitude Production Distribution

Typical Characteristics (continued)

At $T_A = 25^\circ\text{C}$, $V_S = 5\text{ V}$, and $R_L = 10\text{ k}\Omega$ connected to $V_S/2$, unless otherwise noted.



7 Detailed Description

7.1 Overview

The OPA340 series operational amplifiers are fabricated on a state-of-the-art, 0.6-micron CMOS process. These devices are unity-gain stable and suitable for a wide range of general-purpose applications. Rail-to-rail input and output make them ideal for driving sampling A/D converters. In addition, excellent AC performance makes them well-suited for audio applications. The class AB output stage is capable of driving 600-Ω loads series and extends 500 mV beyond the supply. Rail-to-rail input and output swing significantly increases dynamic range, especially in low-supply applications. Figure 23 shows the input and output waveforms for the OPA340 in unity-gain configuration. Operation is from a single 5-V supply with a 10-kΩ load connected to V/2. The input is a 5-V_{PP} sinusoid. Output voltage is approximately 4.98 V_{PP}. Power-supply pins must be bypassed with 0.01-μF ceramic capacitors.



Figure 23. Rail-to-Rail Input and Output

7.2 Functional Block Diagram



Copyright © 2016, Texas Instruments Incorporated

7.3 Feature Description

7.3.1 Operating Voltage

The OPA340 series operational amplifiers are fully specified from 2.7 V to 5 V. However, supply voltage may range from 2.5 V to 5.5 V. Parameters are ensured over the specified supply range—a unique feature of the OPA340 series. In addition, many specifications apply from -40°C to 85°C . Most behavior remains virtually unchanged throughout the full operating voltage range. Parameters which vary significantly with operating voltages or temperature are shown in the *Typical Characteristics*.

7.3.2 Rail-to-Rail Input

The input common-mode voltage range of the OPA340 series extends 500 mV beyond the supply rails. This extended range is achieved with a complementary input stage—an N-channel input differential pair in parallel with a P-channel differential pair. The N-channel pair is active for input voltages close to the positive rail, typically $(V+) - 1.3\text{ V}$ to 500 mV above the positive supply, while the P-channel pair is on for inputs from 500 mV below the negative supply to approximately $(V+) - 1.3\text{ V}$. There is a small transition region, typically $(V+) - 1.5\text{ V}$ to $(V+) - 1.1\text{ V}$, in which both pairs are on. This 400-mV transition region can vary $\pm 300\text{ mV}$ with process variation. Thus, the transition region (both stages on) can range from $(V+) - 1.8\text{ V}$ to $(V+) - 1.4\text{ V}$ on the low end, up to $(V+) - 1.2\text{ V}$ to $(V+) - 0.8\text{ V}$ on the high end.

OPA340 series operational amplifiers are laser-trimmed to reduce offset voltage difference between the N-channel and P-channel input stages, resulting in improved common-mode rejection and a smooth transition between the N-channel pair and the P-channel pair. However, within the 400-mV transition region PSRR, CMRR, offset voltage, offset drift, and THD may be degraded compared to operation outside this region.

A double-folded cascode adds the signal from the two input pairs and presents a differential signal to the class AB output stage. Normally, input bias current is approximately 200 fA; however, input voltages exceeding the power supplies by more than 500 mV can cause excessive current to flow in or out of the input pins. Momentary voltages greater than 500 mV beyond the power supply can be tolerated if the current on the input pins is limited to 10 mA. This current limiting is easily accomplished with an input resistor, as shown in Figure 24. Many input signals are inherently current-limited to less than 10 mA; therefore, a limiting resistor is not required.

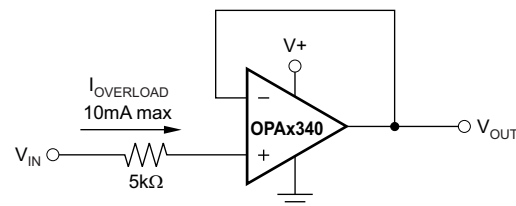

Copyright © 2016, Texas Instruments Incorporated

Figure 24. Input Current Protection for Voltages Exceeding the Supply Voltage

7.3.3 Rail-to-Rail Output

A class AB output stage with common-source transistors is used to achieve rail-to-rail output. For light resistive loads ($> 50\text{ k}\Omega$), the output voltage is typically a few millivolts from the supply rails. With moderate resistive loads ($2\text{ k}\Omega$ to $50\text{ k}\Omega$), the output can swing to within a few tens of millivolts from the supply rails and maintain high open-loop gain (see Figure 15).

7.3.4 Capacitive Load and Stability

OPA340 series operational amplifiers can drive a wide range of capacitive loads. However, all operational amplifiers under certain conditions can become unstable. Operational amplifier configuration, gain, and load value are some of the factors to consider when determining stability. An operational amplifier in unity-gain configuration is most susceptible to the effects of capacitive load. The capacitive load reacts with the output resistance of the operational amplifier, along with any additional load resistance, to create a pole in the small-signal response that degrades the phase margin. In unity-gain configuration, the OPA340 series operational amplifiers perform well, with a pure capacitive load up to approximately 1000 pF. Increasing gain enhances the amplifier ability to drive more capacitance (see Figure 21).

Feature Description (continued)

One method of improving capacitive load drive in the unity-gain configuration is to insert a 10-Ω to 20-Ω resistor in series with the output, as shown in Figure 25. This resistor significantly reduces ringing with large capacitive loads. However, if there is a resistive load in parallel with the capacitive load, it creates a voltage divider introducing a DC error at the output and slightly reduces output swing. This error can be insignificant. For instance, with $R_L = 10\text{ k}\Omega$ and $R_S = 20\ \Omega$, there is only an approximate 0.2% error at the output.

When used with the miniature package options of the OPA340 series, the combination is ideal for space-limited and low-power applications. For further information, consult the ADS7816 data sheet, *12-Bit High Speed Micro Power Sampling Analog-To-Digital Converter* (SBAS061). With the OPA340 in a noninverting configuration, an RC network at the output of the amplifier can be used to filter high-frequency noise in the signal (see Figure 26). In the inverting configuration, filtering may be accomplished with a capacitor across the feedback resistor (see Figure 27).



Copyright © 2016, Texas Instruments Incorporated

Figure 25. Series Resistor in Unity-Gain Configuration Improves Capacitive Load Drive

7.3.5 Driving A/D Converters

The OPA340 series operational amplifiers are optimized for driving medium-speed (up to 100 kHz) sampling A/D converters. However, they also offer excellent performance for higher speed converters. The OPA340 series provides an effective means of buffering the converter input capacitance and resulting charge injection while providing signal gain. Figure 26 and Figure 27 show the OPA340 driving an ADS7816. The ADS7816 is a 12-bit, micro-power sampling converter in the tiny 8-pin VSSOP package.

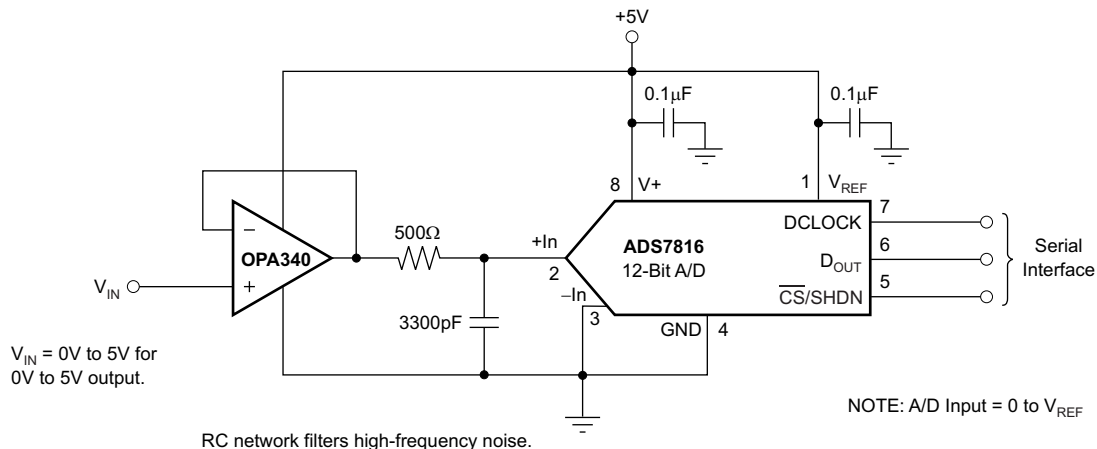

Copyright © 2016, Texas Instruments Incorporated

Figure 26. OPA340 in Noninverting Configuration Driving ADS7816

Feature Description (continued)



Figure 27. OPA340 in Inverting Configuration Driving ADS7816



Figure 28. Speech Bandpass Filter

7.4 Device Functional Modes

The OPAx340 has a single functional mode and is operational when the power-supply voltage is greater than 2.7 V (± 1.35 V). The maximum power supply voltage for the OPAx340 is 5.5 V (± 2.75 V).

8 Application and Implementation

NOTE

Information in the following applications sections is not part of the TI component specification, and TI does not warrant its accuracy or completeness. TI's customers are responsible for determining suitability of components for their purposes. Customers should validate and test their design implementation to confirm system functionality.

8.1 Application Information

The OPAx340 amplifier is a single-supply, CMOS operational amplifier with 5.5-MHz unity-gain bandwidth and supply current of 950 μ A. Its performance is optimized for low-voltage (2.7 V to 5.5 V), single-supply applications, with its input common-mode voltage linear range extending 300 mV beyond the rails and the output voltage swing within 5 mV of either rail. The OPAx340 series features wide bandwidth and unity-gain stability with rail-to-rail input and output for increased dynamic range. Power-supply pins must be bypassed with 0.01- μ F ceramic capacitors.

8.2 Typical Applications

8.2.1 Single-Pole, Low-Pass Filter

Figure 29 shows the OPA340 in a typical noninverting application with the input signal bandwidth limited by the input lowpass filter.



Copyright © 2016, Texas Instruments Incorporated

Figure 29. Single-Pole, Low-Pass Filter

Equation 1 through Equation 2 show calculations for corner frequency and gain:

$$f_{-3\text{ dB}} = \frac{1}{2\pi R_1 C_1} \quad (1)$$

$$\frac{V_{\text{OUT}}}{V_{\text{IN}}} = \left(1 + \frac{R_F}{R_G}\right) \left(\frac{1}{1 + sR_1 C_1}\right) \quad (2)$$

Typical Applications (continued)

8.2.1.1 Design Requirements

When receiving low-level signals, limiting the bandwidth of the incoming signals into the system is often required. The simplest way to establish this limited bandwidth is to place an RC filter at the noninverting terminal of the amplifier, as shown in Figure 29. If a steeper attenuation level is required, a two-pole or higher-order filter may be used.

8.2.1.2 Detailed Design Procedure

The design goals for this circuit include these parameters:

- A noninverting gain of 10 V/V (20 dB)
- Design a single-pole response circuit with –3-dB rolloff at 15.9 kHz and 159 Hz
- Modify the design to increase attenuation level to –40 dB/decade (Sallen-Key Filter)

Use these design values:

- $C_1 = 0$ nF, 10 nF, 1 μ F
- $R_1 = 1$ k Ω
- $R_G = 10$ k Ω
- $R_F = 90$ k Ω

Figure 30 shows how the output voltage of OPA340 changes over frequency depending on the value of C_1 with a constant R_1 of 1 k Ω . Without any filtering of the input signal ($C_1 = 0$), the –3-dB effective bandwidth is a function of the OPA340 unity-gain bandwidth and closed-loop gain, $f_{(-3dB)} = UGBW/A_{CL}$, where A_{CL} is closed-loop gain and UGBW denotes unity-gain bandwidth. Thus, for a closed-loop gain = 10, $f_{(-3dB)} = 1$ MHz/10 = 100 kHz; see Figure 30.

To further limit the output bandwidth, an appropriate choice of C_1 must be made: for $C_1 = 10$ nF,

$$f_c = \frac{1}{2\pi \times R_1 C_1} = \frac{1}{2\pi \times 1^3 \times 1^{-8}} = 15.9 \text{ kHz.}$$

To further limit the bandwidth, a larger C_1 must be used: choosing $C_1 = 1$ μ F,

$$f_c = \frac{1}{2\pi \times R_1 C_1} = \frac{1}{2\pi \times 1^3 \times 1^{-6}} = 159 \text{ Hz (see Figure 30).}$$

8.2.1.3 Application Curve

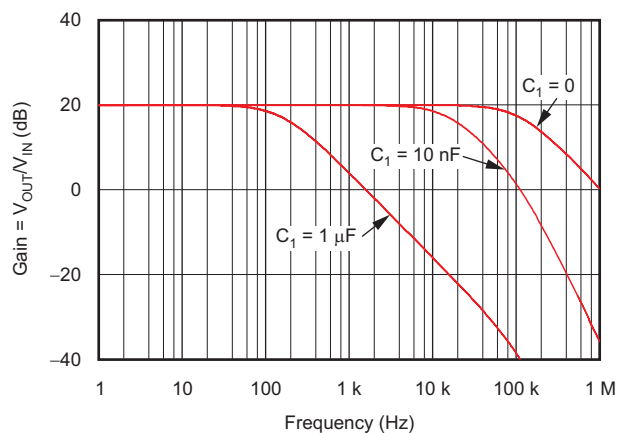

Figure 30. OPA340 Single-Pole AC Gain vs Frequency Response

Typical Applications (continued)

8.2.2 Two-Pole, Low-Pass Filter

If even more attenuation is required, a multiple pole filter is required. The Sallen-Key filter may be used for this task, as shown in Figure 31. For best results, the amplifier must have effective bandwidth that is at least 10 times higher than the filter cutoff frequency. Failure to follow this guideline results in a phase shift of the amplifier, which in turn leads to lower precision of the filter bandwidth. Additionally, to minimize the loading effect between multiple RC pairs on overall the filter cutoff frequency, choose $R = 10 \times R_1$ and $C_2 = C_1/10$; see Figure 32.



Figure 31. Two-Pole, Lowpass Filter

Equation 3 through Equation 5 show calculations for corner frequency and gain:

$$f_c = \frac{1}{2\pi\sqrt{R_1 C_1 R_2 C_2}} \quad (3)$$

$$\frac{V_{OUT(s)}}{V_{IN(s)}} = \frac{G(2\pi f_c)^2}{s^2 + 2\zeta(2\pi f_c)s + (2\pi f_c)^2} \quad (4)$$

$$G = \frac{R_G + R_F}{R_G} \quad (5)$$

8.2.2.1 Detailed Design Procedure

Use these design values:

- $C_1 = 10 \text{ nF}$ and $C_2 = 1 \text{ nF}$
- $R_1 = 1 \text{ k}\Omega$ and $R_2 = 10 \text{ k}\Omega$
- $R_G = 10 \text{ k}\Omega$
- $R_F = 90 \text{ k}\Omega$

Figure 32 shows the Sallen-Key filter second-order response for different RC values: for R and C values above,

$$f_c = \frac{1}{2\pi\sqrt{R_1 C_1 R_2 C_2}} = \frac{1}{2\pi\sqrt{1^3 \times 1^{-8} \times 1^4 \times 1^{-9}}} = 15.9 \text{ kHz.}$$

To further limit the bandwidth, a larger RC value must be used: increasing C values 100 times, such as $C_1 = 1 \text{ }\mu\text{F}$ and $C_2 = 0.1 \text{ }\mu\text{F}$, with unchanged resistors, results in the second-order rolloff at

$$f_c = \frac{1}{2\pi\sqrt{R_1 C_1 R_2 C_2}} = \frac{1}{2\pi\sqrt{1^3 \times 1^{-6} \times 1^4 \times 1^{-7}}} = 159 \text{ Hz. See Figure 32.}$$

Typical Applications (continued)

8.2.2.2 Application Curve

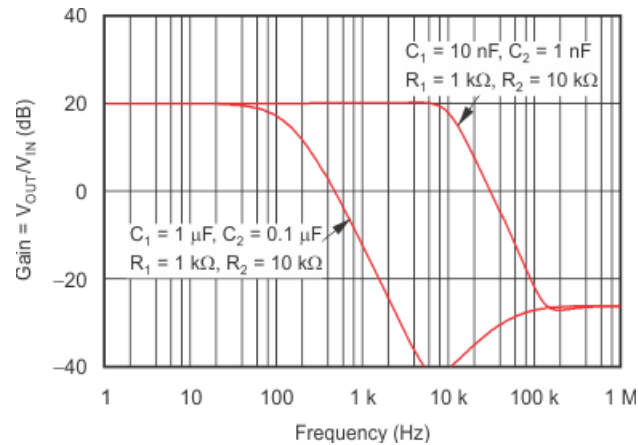

Figure 32. OPA340 Two-Pole, Lowpass Sallen-Key AC Gain vs Frequency Response

9 Power Supply Recommendations

The OPAx340 is specified for operation from 2.7 V to 5.5 V (± 1.35 V to ± 2.75 V).

CAUTION

Supply voltages larger than 7 V can permanently damage the device (see the [Absolute Maximum Ratings](#)).

TI recommends placing 0.1- μ F bypass capacitors close to the power-supply pins to reduce errors coupling in from noisy or high-impedance power supplies.

10 Layout

10.1 Layout Guidelines

Pay attention to good layout practices. Keep traces short and when possible, use a printed-circuit board (PCB) ground plane with surface-mount components placed as close to the device pins as possible. Place a 0.1- μ F capacitor closely across the supply pins. Apply these guidelines throughout the analog circuit to improve performance and provide benefits, such as reducing the electromagnetic interference (EMI) susceptibility.

Operational amplifiers vary in susceptibility to radio frequency interference (RFI). RFI can generally be identified as a variation in offset voltage or DC signal levels with changes in the interfering RF signal. The OPA340 is specifically designed to minimize susceptibility to RFI and demonstrates remarkably low sensitivity compared to previous generation devices. Strong RF fields can still cause varying offset levels.

10.2 Layout Example

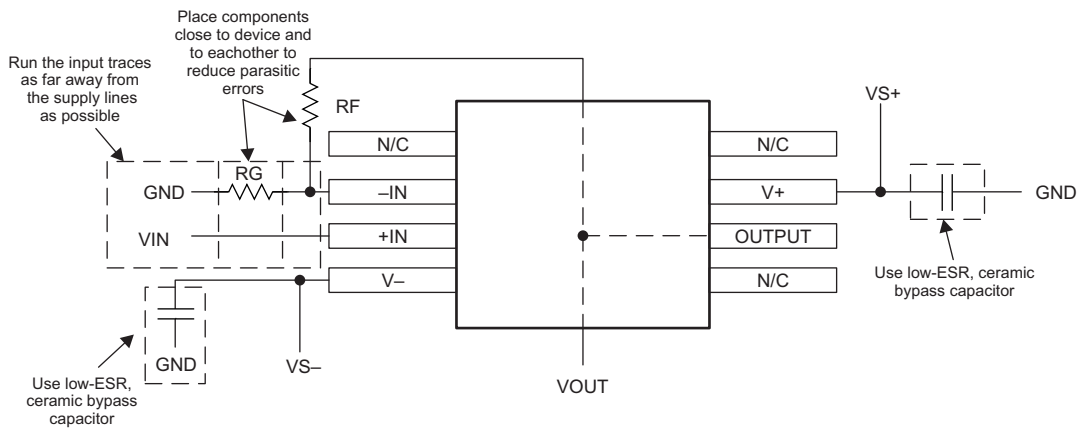

Copyright © 2016, Texas Instruments Incorporated

Figure 33. Layout Recommendation

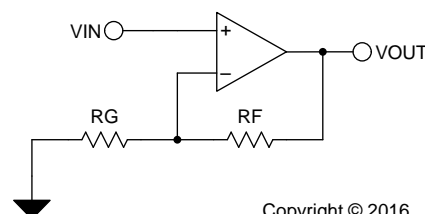

Copyright © 2016,
Texas Instruments Incorporated

Figure 34. Schematic Representation

11 Device and Documentation Support

11.1 Device Support

11.1.1 Development Support

11.1.1.1 TINA-TI™ (Free Software Download)

TINA™ is a simple, powerful, and easy-to-use circuit simulation program based on a SPICE engine. TINA-TI™ is a free, fully-functional version of the TINA software, preloaded with a library of macro models in addition to a range of both passive and active models. TINA-TI provides all the conventional DC, transient, and frequency domain analysis of SPICE, as well as additional design capabilities.

Available as a [free download](#) from the Analog eLab Design Center, TINA-TI offers extensive post-processing capability that allows users to format results in a variety of ways. Virtual instruments offer the ability to select input waveforms and probe circuit nodes, voltages, and waveforms, creating a dynamic quick-start tool.

NOTE

These files require that either the TINA software (from DesignSoft™) or TINA-TI software be installed. Download the free TINA-TI software from the [TINA-TI folder](#).

11.1.1.2 DIP Adapter EVM

The [DIP Adapter EVM](#) tool provides an easy, low-cost way to prototype small surface mount ICs. The evaluation tool these TI packages: D or U (SOIC-8), PW (TSSOP-8), DGK (MSOP-8), DBV (SOT23-6, SOT23-5 and SOT23-3), DCK (SC70-6 and SC70-5), and DRL (SOT563-6). The DIP Adapter EVM may also be used with terminal strips or may be wired directly to existing circuits.

11.1.1.3 Universal Operational Amplifier EVM

The [Universal Op Amp EVM](#) is a series of general-purpose, blank circuit boards that simplify prototyping circuits for a variety of IC package types. The evaluation module board design allows many different circuits to be constructed easily and quickly. Five models are offered, with each model intended for a specific package type. PDIP, SOIC, MSOP, TSSOP and SOT23 packages are all supported.

NOTE

These boards are unpopulated, so users must provide their own ICs. TI recommends requesting several operational amplifier device samples when ordering the Universal Op Amp EVM.

11.1.1.4 TI Precision Designs

TI Precision Designs are analog solutions created by TI's precision analog applications experts and offer the theory of operation, component selection, simulation, complete PCB schematic and layout, bill of materials, and measured performance of many useful circuits. TI Precision Designs are available online at <http://www.ti.com/ww/en/analog/precision-designs/>.

11.1.1.5 WEBENCH® Filter Designer

[WEBENCH® Filter Designer](#) is a simple, powerful, and easy-to-use active filter design program. The WEBENCH Filter Designer lets you create optimized filter designs using a selection of TI operational amplifiers and passive components from TI's vendor partners.

Available as a web-based tool from the WEBENCH® Design Center, [WEBENCH® Filter Designer](#) allows you to design, optimize, and simulate complete multistage active filter solutions within minutes.

11.2 Documentation Support

11.2.1 Related Documentation

For related documentation, see the following application reports and publications (available for download from www.ti.com):

- [12-Bit High Speed Micro Power Sampling Analog-To-Digital Converter](#) (SBAS061)
- [A Dual-Polarity, Bidirectional Current-Shunt Monitor](#) (SLYT311)
- [OPA340, OPA2340, OPA4340 EMI Immunity Performance](#) (SBOZ010)
- [Getting the Full Potential from your ADC](#) (SBAA069)
- [Feedback Plots Define Op Amp AC Performance](#) (SBOA015)
- [Capacitive Load Drive Solution Using an Isolation Resistor](#) (TIPD128)
- [Circuit Board Layout Techniques](#) (SLOA089)

11.3 Related Links

Table 1 lists quick access links. Categories include technical documents, support and community resources, tools and software, and quick access to sample or buy.

Table 1. Related Links

PARTS	PRODUCT FOLDER	SAMPLE & BUY	TECHNICAL DOCUMENTS	TOOLS & SOFTWARE	SUPPORT & COMMUNITY
OPA340	Click here	Click here	Click here	Click here	Click here
OPA2340	Click here	Click here	Click here	Click here	Click here
OPA4340	Click here	Click here	Click here	Click here	Click here

11.4 Receiving Notification of Documentation Updates

To receive notification of documentation updates, navigate to the device product folder on ti.com. In the upper right corner, click on *Alert me* to register and receive a weekly digest of any product information that has changed. For change details, review the revision history included in any revised document.

11.5 Community Resources

The following links connect to TI community resources. Linked contents are provided "AS IS" by the respective contributors. They do not constitute TI specifications and do not necessarily reflect TI's views; see TI's [Terms of Use](#).

TI E2E™ Online Community *TI's Engineer-to-Engineer (E2E) Community*. Created to foster collaboration among engineers. At e2e.ti.com, you can ask questions, share knowledge, explore ideas and help solve problems with fellow engineers.

Design Support *TI's Design Support* Quickly find helpful E2E forums along with design support tools and contact information for technical support.

11.6 Trademarks

MicroAmplifier, TINA-TI, E2E are trademarks of Texas Instruments.
 WEBENCH is a registered trademark of Texas Instruments.
 TINA, DesignSoft are trademarks of DesignSoft, Inc.
 All other trademarks are the property of their respective owners.

11.7 Electrostatic Discharge Caution



These devices have limited built-in ESD protection. The leads should be shorted together or the device placed in conductive foam during storage or handling to prevent electrostatic damage to the MOS gates.

11.8 Glossary

[SLYZ022](#) — *TI Glossary*.

This glossary lists and explains terms, acronyms, and definitions.

12 Mechanical, Packaging, and Orderable Information

The following pages include mechanical, packaging, and orderable information. This information is the most current data available for the designated devices. This data is subject to change without notice and revision of this document. For browser-based versions of this data sheet, refer to the left-hand navigation.

PACKAGING INFORMATION

Orderable Device	Status (1)	Package Type	Package Drawing	Pins	Package Qty	Eco Plan (2)	Lead/Ball Finish (6)	MSL Peak Temp (3)	Op Temp (°C)	Device Marking (4/5)	Samples
OPA2340EA/250	ACTIVE	VSSOP	DGK	8	250	Green (RoHS & no Sb/Br)	CU NIPDAUAG	Level-2-260C-1 YEAR		A40A	Samples
OPA2340EA/250G4	ACTIVE	VSSOP	DGK	8	250	Green (RoHS & no Sb/Br)	CU NIPDAUAG	Level-2-260C-1 YEAR		A40A	Samples
OPA2340EA/2K5	ACTIVE	VSSOP	DGK	8	2500	Green (RoHS & no Sb/Br)	CU NIPDAUAG	Level-2-260C-1 YEAR		A40A	Samples
OPA2340EA/2K5G4	ACTIVE	VSSOP	DGK	8	2500	Green (RoHS & no Sb/Br)	CU NIPDAUAG	Level-2-260C-1 YEAR		A40A	Samples
OPA2340PA	ACTIVE	PDIP	P	8	50	Green (RoHS & no Sb/Br)	CU NIPDAU	N / A for Pkg Type		OPA2340PA	Samples
OPA2340PAG4	ACTIVE	PDIP	P	8	50	Green (RoHS & no Sb/Br)	CU NIPDAU	N / A for Pkg Type		OPA2340PA	Samples
OPA2340UA	ACTIVE	SOIC	D	8	75	Green (RoHS & no Sb/Br)	CU NIPDAU	Level-2-260C-1 YEAR	-40 to 85	OPA 2340UA	Samples
OPA2340UA/2K5	ACTIVE	SOIC	D	8	2500	Green (RoHS & no Sb/Br)	CU NIPDAU	Level-2-260C-1 YEAR		OPA 2340UA	Samples
OPA2340UA/2K5G4	ACTIVE	SOIC	D	8	2500	Green (RoHS & no Sb/Br)	CU NIPDAU	Level-2-260C-1 YEAR		OPA 2340UA	Samples
OPA340NA/250	ACTIVE	SOT-23	DBV	5	250	Green (RoHS & no Sb/Br)	CU NIPDAU	Level-2-260C-1 YEAR	-40 to 85	A40	Samples
OPA340NA/250G4	ACTIVE	SOT-23	DBV	5	250	Green (RoHS & no Sb/Br)	CU NIPDAU	Level-2-260C-1 YEAR	-40 to 85	A40	Samples
OPA340NA/3K	ACTIVE	SOT-23	DBV	5	3000	Green (RoHS & no Sb/Br)	CU NIPDAU	Level-2-260C-1 YEAR	-40 to 85	A40	Samples
OPA340NA/3KG4	ACTIVE	SOT-23	DBV	5	3000	Green (RoHS & no Sb/Br)	CU NIPDAU	Level-2-260C-1 YEAR	-40 to 85	A40	Samples
OPA340PA	ACTIVE	PDIP	P	8	50	Green (RoHS & no Sb/Br)	CU NIPDAU	N / A for Pkg Type	-40 to 85	OPA340PA	Samples
OPA340UA	ACTIVE	SOIC	D	8	75	Green (RoHS & no Sb/Br)	CU NIPDAU	Level-2-260C-1 YEAR	-40 to 85	OPA 340UA	Samples
OPA340UA/2K5	ACTIVE	SOIC	D	8	2500	Green (RoHS & no Sb/Br)	CU NIPDAU	Level-2-260C-1 YEAR	-40 to 85	OPA 340UA	Samples
OPA340UA/2K5G4	ACTIVE	SOIC	D	8	2500	Green (RoHS & no Sb/Br)	CU NIPDAU	Level-2-260C-1 YEAR	-40 to 85	OPA 340UA	Samples

Orderable Device	Status (1)	Package Type	Package Drawing	Pins	Package Qty	Eco Plan (2)	Lead/Ball Finish (6)	MSL Peak Temp (3)	Op Temp (°C)	Device Marking (4/5)	Samples
OPA4340EA/250	ACTIVE	SSOP	DBQ	16	250	Green (RoHS & no Sb/Br)	CU NIPDAU	Level-2-260C-1 YEAR	-40 to 85	OPA 4340EA	Samples
OPA4340EA/250G4	ACTIVE	SSOP	DBQ	16	250	Green (RoHS & no Sb/Br)	CU NIPDAU	Level-2-260C-1 YEAR	-40 to 85	OPA 4340EA	Samples
OPA4340EA/2K5	ACTIVE	SSOP	DBQ	16	2500	Green (RoHS & no Sb/Br)	CU NIPDAU	Level-2-260C-1 YEAR	-40 to 85	OPA 4340EA	Samples
OPA4340UA	ACTIVE	SOIC	D	14	50	Green (RoHS & no Sb/Br)	CU NIPDAU	Level-3-260C-168 HR	-40 to 85	OPA4340UA	Samples
OPA4340UA/2K5	ACTIVE	SOIC	D	14	2500	Green (RoHS & no Sb/Br)	CU NIPDAU	Level-3-260C-168 HR	-40 to 85	OPA4340UA	Samples
OPA4340UA/2K5G4	ACTIVE	SOIC	D	14	2500	Green (RoHS & no Sb/Br)	CU NIPDAU	Level-3-260C-168 HR	-40 to 85	OPA4340UA	Samples
OPA4340UAG4	ACTIVE	SOIC	D	14	50	Green (RoHS & no Sb/Br)	CU NIPDAU	Level-3-260C-168 HR	-40 to 85	OPA4340UA	Samples

(1) The marketing status values are defined as follows:

ACTIVE: Product device recommended for new designs.

LIFEBUY: TI has announced that the device will be discontinued, and a lifetime-buy period is in effect.

NRND: Not recommended for new designs. Device is in production to support existing customers, but TI does not recommend using this part in a new design.

PREVIEW: Device has been announced but is not in production. Samples may or may not be available.

OBSOLETE: TI has discontinued the production of the device.

(2) **RoHS:** TI defines "RoHS" to mean semiconductor products that are compliant with the current EU RoHS requirements for all 10 RoHS substances, including the requirement that RoHS substance do not exceed 0.1% by weight in homogeneous materials. Where designed to be soldered at high temperatures, "RoHS" products are suitable for use in specified lead-free processes. TI may reference these types of products as "Pb-Free".

RoHS Exempt: TI defines "RoHS Exempt" to mean products that contain lead but are compliant with EU RoHS pursuant to a specific EU RoHS exemption.

Green: TI defines "Green" to mean the content of Chlorine (Cl) and Bromine (Br) based flame retardants meet JS709B low halogen requirements of <=1000ppm threshold. Antimony trioxide based flame retardants must also meet the <=1000ppm threshold requirement.

(3) MSL, Peak Temp. - The Moisture Sensitivity Level rating according to the JEDEC industry standard classifications, and peak solder temperature.

(4) There may be additional marking, which relates to the logo, the lot trace code information, or the environmental category on the device.

(5) Multiple Device Markings will be inside parentheses. Only one Device Marking contained in parentheses and separated by a "~" will appear on a device. If a line is indented then it is a continuation of the previous line and the two combined represent the entire Device Marking for that device.

⁽⁶⁾ Lead/Ball Finish - Orderable Devices may have multiple material finish options. Finish options are separated by a vertical ruled line. Lead/Ball Finish values may wrap to two lines if the finish value exceeds the maximum column width.

Important Information and Disclaimer:The information provided on this page represents TI's knowledge and belief as of the date that it is provided. TI bases its knowledge and belief on information provided by third parties, and makes no representation or warranty as to the accuracy of such information. Efforts are underway to better integrate information from third parties. TI has taken and continues to take reasonable steps to provide representative and accurate information but may not have conducted destructive testing or chemical analysis on incoming materials and chemicals. TI and TI suppliers consider certain information to be proprietary, and thus CAS numbers and other limited information may not be available for release.

In no event shall TI's liability arising out of such information exceed the total purchase price of the TI part(s) at issue in this document sold by TI to Customer on an annual basis.

OTHER QUALIFIED VERSIONS OF OPA340 :

- Enhanced Product: [OPA340-EP](#)

NOTE: Qualified Version Definitions:

- Enhanced Product - Supports Defense, Aerospace and Medical Applications

TAPE AND REEL INFORMATION

QUADRANT ASSIGNMENTS FOR PIN 1 ORIENTATION IN TAPE

*All dimensions are nominal

Device	Package Type	Package Drawing	Pins	SPQ	Reel Diameter (mm)	Reel Width W1 (mm)	A0 (mm)	B0 (mm)	K0 (mm)	P1 (mm)	W (mm)	Pin1 Quadrant
OPA2340EA/250	VSSOP	DGK	8	250	330.0	12.4	5.3	3.4	1.4	8.0	12.0	Q1
OPA2340EA/2K5	VSSOP	DGK	8	2500	330.0	12.4	5.3	3.4	1.4	8.0	12.0	Q1
OPA340NA/250	SOT-23	DBV	5	250	179.0	8.4	3.2	3.2	1.4	4.0	8.0	Q3
OPA340NA/250	SOT-23	DBV	5	250	178.0	9.0	3.3	3.2	1.4	4.0	8.0	Q3
OPA340NA/3K	SOT-23	DBV	5	3000	178.0	9.0	3.3	3.2	1.4	4.0	8.0	Q3
OPA340NA/3K	SOT-23	DBV	5	3000	179.0	8.4	3.2	3.2	1.4	4.0	8.0	Q3
OPA4340EA/250	SSOP	DBQ	16	250	180.0	12.4	6.4	5.2	2.1	8.0	12.0	Q1
OPA4340EA/2K5	SSOP	DBQ	16	2500	330.0	12.4	6.4	5.2	2.1	8.0	12.0	Q1
OPA4340UA/2K5	SOIC	D	14	2500	330.0	16.4	6.5	9.0	2.1	8.0	16.0	Q1

TAPE AND REEL BOX DIMENSIONS

*All dimensions are nominal

Device	Package Type	Package Drawing	Pins	SPQ	Length (mm)	Width (mm)	Height (mm)
OPA2340EA/250	VSSOP	DGK	8	250	366.0	364.0	50.0
OPA2340EA/2K5	VSSOP	DGK	8	2500	366.0	364.0	50.0
OPA340NA/250	SOT-23	DBV	5	250	195.0	200.0	45.0
OPA340NA/250	SOT-23	DBV	5	250	180.0	180.0	18.0
OPA340NA/3K	SOT-23	DBV	5	3000	180.0	180.0	18.0
OPA340NA/3K	SOT-23	DBV	5	3000	195.0	200.0	45.0
OPA4340EA/250	SSOP	DBQ	16	250	210.0	185.0	35.0
OPA4340EA/2K5	SSOP	DBQ	16	2500	367.0	367.0	35.0
OPA4340UA/2K5	SOIC	D	14	2500	367.0	367.0	38.0

D (R-PDSO-G14)

PLASTIC SMALL OUTLINE



- NOTES:
- A. All linear dimensions are in inches (millimeters).
 - B. This drawing is subject to change without notice.
 -  Body length does not include mold flash, protrusions, or gate burrs. Mold flash, protrusions, or gate burrs shall not exceed 0.006 (0,15) each side.
 -  Body width does not include interlead flash. Interlead flash shall not exceed 0.017 (0,43) each side.
 - E. Reference JEDEC MS-012 variation AB.

D (R-PDSO-G14)

PLASTIC SMALL OUTLINE



4211283-3/E 08/12

- NOTES:
- All linear dimensions are in millimeters.
 - This drawing is subject to change without notice.
 - Publication IPC-7351 is recommended for alternate designs.
 - Laser cutting apertures with trapezoidal walls and also rounding corners will offer better paste release. Customers should contact their board assembly site for stencil design recommendations. Refer to IPC-7525 for other stencil recommendations.
 - Customers should contact their board fabrication site for solder mask tolerances between and around signal pads.



D0008A

PACKAGE OUTLINE

SOIC - 1.75 mm max height

SMALL OUTLINE INTEGRATED CIRCUIT



4214825/C 02/2019

NOTES:

- Linear dimensions are in inches [millimeters]. Dimensions in parenthesis are for reference only. Controlling dimensions are in inches. Dimensioning and tolerancing per ASME Y14.5M.
- This drawing is subject to change without notice.
- This dimension does not include mold flash, protrusions, or gate burrs. Mold flash, protrusions, or gate burrs shall not exceed $.006$ [0.15] per side.
- This dimension does not include interlead flash.
- Reference JEDEC registration MS-012, variation AA.

EXAMPLE BOARD LAYOUT

D0008A

SOIC - 1.75 mm max height

SMALL OUTLINE INTEGRATED CIRCUIT



LAND PATTERN EXAMPLE
 EXPOSED METAL SHOWN
 SCALE:8X



SOLDER MASK DETAILS

4214825/C 02/2019

NOTES: (continued)

- 6. Publication IPC-7351 may have alternate designs.
- 7. Solder mask tolerances between and around signal pads can vary based on board fabrication site.

EXAMPLE STENCIL DESIGN

D0008A

SOIC - 1.75 mm max height

SMALL OUTLINE INTEGRATED CIRCUIT



SOLDER PASTE EXAMPLE
BASED ON .005 INCH [0.125 MM] THICK STENCIL
SCALE:8X

4214825/C 02/2019

NOTES: (continued)

8. Laser cutting apertures with trapezoidal walls and rounded corners may offer better paste release. IPC-7525 may have alternate design recommendations.
9. Board assembly site may have different recommendations for stencil design.

GENERIC PACKAGE VIEW

DBQ 16

SSOP - 1.75 mm max height

SHRINK SMALL-OUTLINE PACKAGE

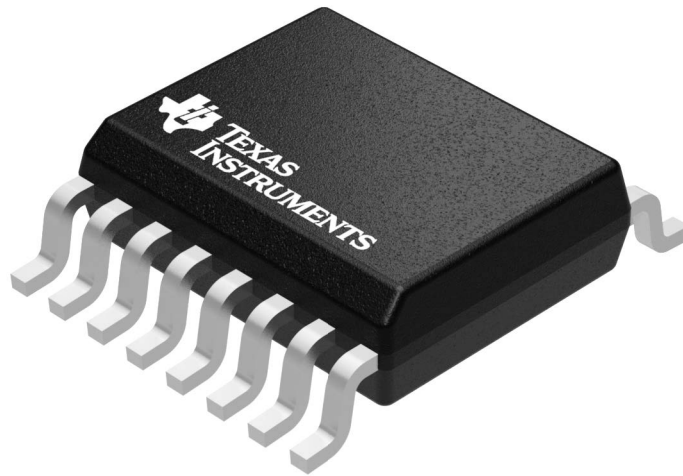

Images above are just a representation of the package family, actual package may vary.
Refer to the product data sheet for package details.

4073301-2/1

EXAMPLE BOARD LAYOUT

DBQ0016A

SSOP - 1.75 mm max height

SHRINK SMALL-OUTLINE PACKAGE

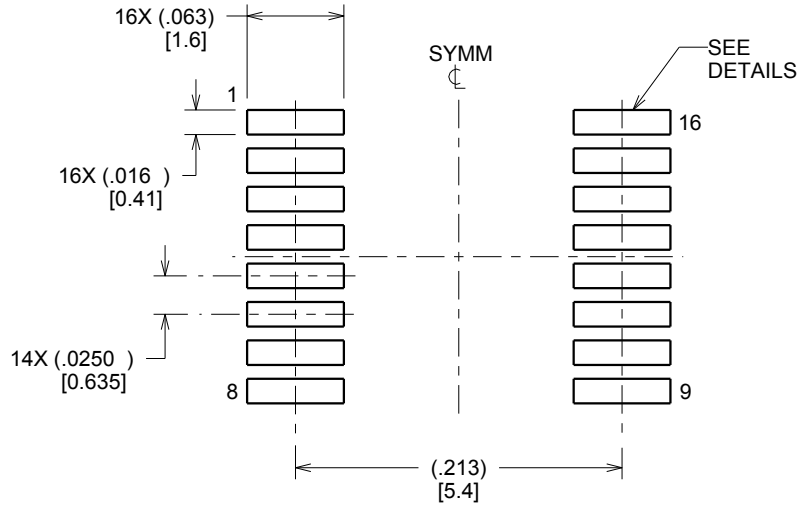

LAND PATTERN EXAMPLE
SCALE:8X



SOLDER MASK DETAILS

4214846/A 03/2014

NOTES: (continued)

- 6. Publication IPC-7351 may have alternate designs.
- 7. Solder mask tolerances between and around signal pads can vary based on board fabrication site.

EXAMPLE STENCIL DESIGN

DBQ0016A

SSOP - 1.75 mm max height

SHRINK SMALL-OUTLINE PACKAGE



SOLDER PASTE EXAMPLE
BASED ON .005 INCH [0.127 MM] THICK STENCIL
SCALE:8X

4214846/A 03/2014

NOTES: (continued)

8. Laser cutting apertures with trapezoidal walls and rounded corners may offer better paste release. IPC-7525 may have alternate design recommendations.
9. Board assembly site may have different recommendations for stencil design.

P (R-PDIP-T8)

PLASTIC DUAL-IN-LINE PACKAGE



- NOTES:
- A. All linear dimensions are in inches (millimeters).
 - B. This drawing is subject to change without notice.
 - C. Falls within JEDEC MS-001 variation BA.

DBV0005A



PACKAGE OUTLINE

SOT-23 - 1.45 mm max height

SMALL OUTLINE TRANSISTOR



4214839/D 11/2018

NOTES:

1. All linear dimensions are in millimeters. Any dimensions in parenthesis are for reference only. Dimensioning and tolerancing per ASME Y14.5M.
2. This drawing is subject to change without notice.
3. Reference JEDEC MO-178.
4. Body dimensions do not include mold flash, protrusions, or gate burrs. Mold flash, protrusions, or gate burrs shall not exceed 0.15 mm per side.

EXAMPLE BOARD LAYOUT

DBV0005A

SOT-23 - 1.45 mm max height

SMALL OUTLINE TRANSISTOR



LAND PATTERN EXAMPLE
EXPOSED METAL SHOWN
SCALE:15X



SOLDER MASK DETAILS

4214839/D 11/2018

NOTES: (continued)

- 5. Publication IPC-7351 may have alternate designs.
- 6. Solder mask tolerances between and around signal pads can vary based on board fabrication site.

EXAMPLE STENCIL DESIGN

DBV0005A

SOT-23 - 1.45 mm max height

SMALL OUTLINE TRANSISTOR



SOLDER PASTE EXAMPLE
BASED ON 0.125 mm THICK STENCIL
SCALE:15X

4214839/D 11/2018

NOTES: (continued)

7. Laser cutting apertures with trapezoidal walls and rounded corners may offer better paste release. IPC-7525 may have alternate design recommendations.
8. Board assembly site may have different recommendations for stencil design.



- NOTES:
- A. All linear dimensions are in millimeters.
 - B. This drawing is subject to change without notice.
 - C. Publication IPC-7351 is recommended for alternate designs.
 - D. Laser cutting apertures with trapezoidal walls and also rounding corners will offer better paste release. Customers should contact their board assembly site for stencil design recommendations. Refer to IPC-7525 for other stencil recommendations.
 - E. Customers should contact their board fabrication site for solder mask tolerances between and around signal pads.

IMPORTANT NOTICE AND DISCLAIMER

TI PROVIDES TECHNICAL AND RELIABILITY DATA (INCLUDING DATASHEETS), DESIGN RESOURCES (INCLUDING REFERENCE DESIGNS), APPLICATION OR OTHER DESIGN ADVICE, WEB TOOLS, SAFETY INFORMATION, AND OTHER RESOURCES "AS IS" AND WITH ALL FAULTS, AND DISCLAIMS ALL WARRANTIES, EXPRESS AND IMPLIED, INCLUDING WITHOUT LIMITATION ANY IMPLIED WARRANTIES OF MERCHANTABILITY, FITNESS FOR A PARTICULAR PURPOSE OR NON-INFRINGEMENT OF THIRD PARTY INTELLECTUAL PROPERTY RIGHTS.

These resources are intended for skilled developers designing with TI products. You are solely responsible for (1) selecting the appropriate TI products for your application, (2) designing, validating and testing your application, and (3) ensuring your application meets applicable standards, and any other safety, security, or other requirements. These resources are subject to change without notice. TI grants you permission to use these resources only for development of an application that uses the TI products described in the resource. Other reproduction and display of these resources is prohibited. No license is granted to any other TI intellectual property right or to any third party intellectual property right. TI disclaims responsibility for, and you will fully indemnify TI and its representatives against, any claims, damages, costs, losses, and liabilities arising out of your use of these resources.

TI's products are provided subject to TI's Terms of Sale (www.ti.com/legal/termsofsale.html) or other applicable terms available either on ti.com or provided in conjunction with such TI products. TI's provision of these resources does not expand or otherwise alter TI's applicable warranties or warranty disclaimers for TI products.

Mailing Address: Texas Instruments, Post Office Box 655303, Dallas, Texas 75265
Copyright © 2019, Texas Instruments Incorporated

Looking for pricing, stock, or lifecycle information?

Click below to explore more details on WIN SOURCE:

 [View OPA340PA](#) on WIN SOURCE

 [Texas Instruments](#) Information

Optimize Your Supply Chain with WIN SOURCE Solutions

-  Global Sourcing Solution
-  Obsolete Management
-  Cost Control Management
-  Shortage Management
-  Alternative Solution
-  Excess Inventory Management