



**THE DATASHEET OF  
OPA350UA/2K5**



# OPAx350 High-Speed, Single-Supply, Rail-to-Rail Operational Amplifiers MicroAmplifier Series

## 1 Features

- Rail-to-Rail Input
- Rail-to-Rail Output (Within 10 mV)
- Wide Bandwidth: 38 MHz
- High Slew Rate: 22 V/ $\mu$ s
- Low Noise: 5 nV/ $\sqrt{\text{Hz}}$
- Low THD+Noise: 0.0006%
- Unity-Gain Stable
- MicroSize Packages
- Single, Dual, and Quad

## 2 Applications

- Cell Phone PA Control Loops
- Driving A/D Converters
- Video Processing
- Data Acquisition
- Process Controls
- Audio Processing
- Communications
- Active Filters
- Test Equipment

## 3 Description

The OPA350 series of rail-to-rail CMOS operational amplifiers are optimized for low voltage, single-supply operation. Rail-to-rail input and output, low noise (5 nV/ $\sqrt{\text{Hz}}$ ), and high speed operation (38 MHz, 22 V/ $\mu$ s) make the amplifiers ideal for driving sampling Analog-to-Digital (A/D) converters. They are also suited for cell phone PA control loops and video processing (75- $\Omega$  drive capability), as well as audio and general purpose applications. Single, dual, and quad versions have identical specifications for maximum design flexibility.

The OPA350 series operates on a single supply as low as 2.5 V, with an input common-mode voltage range that extends 300 mV below ground and 300 mV above the positive supply. Output voltage swing is to within 10 mV of the supply rails, with a 10-k $\Omega$  load. Dual and quad designs feature completely independent circuitry for lowest crosstalk and freedom from interaction.

The single (OPA350) and dual (OPA2350) come in the miniature MSOP-8 surface mount, SO-8 surface mount, and DIP-8 packages. The quad (OPA4350) packages are in the space-saving SSOP-16 surface mount and SO-14 surface mount. All are specified from  $-40^{\circ}\text{C}$  to  $85^{\circ}\text{C}$  and operate from  $-55^{\circ}\text{C}$  to  $150^{\circ}\text{C}$ .

**OPAx350 Harmonic Distortion**

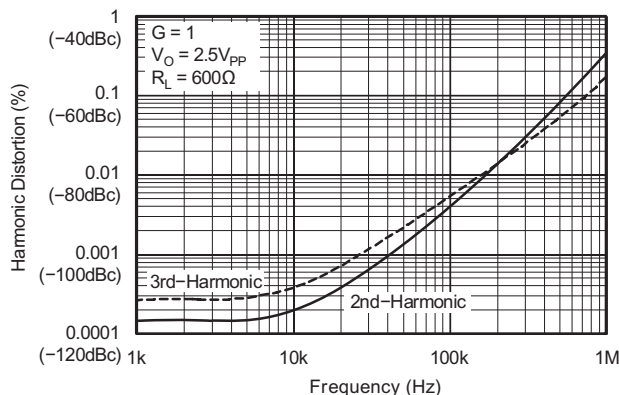

**Device Information<sup>(1)</sup>**

PART NUMBER	PACKAGE	BODY SIZE (NOM)
OPA350	MSOP (8)	3.00 mm x 3.00 mm
	SOIC (8)	3.91 mm x 4.90 mm
	PDIP (8)	6.35 mm x 9.81 mm
OPA2350	MSOP (8)	3.00 mm x 3.00 mm
	SOIC (8)	3.91 mm x 4.90 mm
	PDIP (8)	6.35 mm x 9.81 mm
OPA4350	SSOP (16)	3.90 mm x 4.90 mm
	SOIC (14)	3.91 mm x 8.65 mm

(1) For all available packages, see the orderable addendum at the end of the data sheet.



## Table of Contents

<b>1 Features</b> .....	<b>1</b>	7.4 Device Functional Modes.....	<b>17</b>
<b>2 Applications</b> .....	<b>1</b>	<b>8 Application and Implementation</b> .....	<b>18</b>
<b>3 Description</b> .....	<b>1</b>	8.1 Application Information.....	<b>18</b>
<b>4 Revision History</b> .....	<b>2</b>	8.2 Typical Applications .....	<b>18</b>
<b>5 Pin Configuration and Functions</b> .....	<b>3</b>	<b>9 Power Supply Recommendations</b> .....	<b>22</b>
<b>6 Specifications</b> .....	<b>4</b>	<b>10 Layout</b> .....	<b>22</b>
6.1 Absolute Maximum Ratings .....	<b>4</b>	10.1 Layout Guidelines .....	<b>22</b>
6.2 ESD Ratings .....	<b>4</b>	10.2 Layout Example .....	<b>23</b>
6.3 Recommended Operating Conditions.....	<b>4</b>	<b>11 Device and Documentation Support</b> .....	<b>24</b>
6.4 Thermal Information: OPA350 and OPA2350.....	<b>5</b>	11.1 Device Support .....	<b>24</b>
6.5 Thermal Information: OPA4350 .....	<b>5</b>	11.2 Documentation Support .....	<b>24</b>
6.6 Electrical Characteristics.....	<b>6</b>	11.3 Related Links .....	<b>24</b>
6.7 Typical Characteristics.....	<b>8</b>	11.4 Community Resources.....	<b>25</b>
<b>7 Detailed Description</b> .....	<b>12</b>	11.5 Trademarks .....	<b>25</b>
7.1 Overview .....	<b>12</b>	11.6 Electrostatic Discharge Caution.....	<b>25</b>
7.2 Functional Block Diagram .....	<b>12</b>	11.7 Glossary .....	<b>25</b>
7.3 Feature Description.....	<b>12</b>	<b>12 Mechanical, Packaging, and Orderable Information</b> .....	<b>25</b>

## 4 Revision History

NOTE: Page numbers for previous revisions may differ from page numbers in the current version.

### Changes from Revision C (January 2005) to Revision D

Page

- Added *ESD Ratings* table, *Feature Description* section, *Device Functional Modes*, *Application and Implementation* section, *Power Supply Recommendations* section, *Layout* section, *Device and Documentation Support* section, and *Mechanical, Packaging, and Orderable Information* section. .... **1**

## 5 Pin Configuration and Functions

**OPA350: P, D, and DGK Packages**  
8-Pin PDIP, SOIC, and VSSOP  
Top View

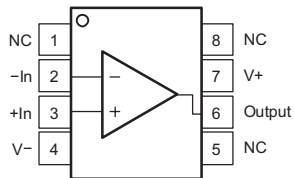

**OPA2350: P, D, and DGK Packages**  
8-Pin PDIP, SOIC, and VSSOP  
Top View



**D Package**  
14-Pin SOIC  
Top View

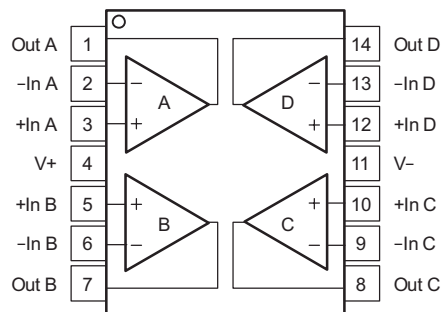

**DBQ Package**  
16-Pin SSOP  
Top View

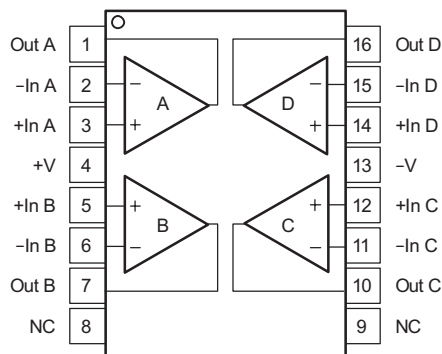

### Pin Functions

NAME	PIN				I/O	DESCRIPTION
	OPA350 NO.	OPA2350 NO.	OPA4350 SO-14 NO.	OPA4350 SSOP NO.		
NC	1, 5, 8	—	—	8, 9	—	No internal connection
-In	2	—	—	—	I	Inverting input
+In	3	—	—	—	I	Noninverting input
V-	4	4	11	13	I	Negative power supply
Output	6	—	—	—	O	Output
V+	7	8	4	4	I	Positive power supply
Out A	—	1	1	1	O	Output channel A
-In A	—	2	2	2	I	Inverting input channel A
+In A	—	3	3	3	I	Noninverting input channel A
+In B	—	5	5	5	I	Noninverting input channel B
-In B	—	6	6	6	I	Inverting input channel B
Out B	—	7	7	7	O	Output channel B
Out C	—	—	8	10	O	Output channel C
-In C	—	—	9	11	I	Inverting input channel C
+In C	—	—	10	12	I	Noninverting input channel C
+In D	—	—	12	14	I	Noninverting input channel D
-In D	—	—	13	15	I	Inverting input channel D
Out D	—	—	14	16	O	Output channel D

## 6 Specifications

### 6.1 Absolute Maximum Ratings

 over operating free-air temperature range (unless otherwise noted) <sup>(1)</sup>

		MIN	MAX	UNIT
Supply voltage		7		V
Signal input terminals <sup>(2)</sup>	Voltage	(V-) - 0.3	(V+) + 0.3	V
	Current	10		mA
Open short circuit current <sup>(3)</sup>		Continuous		
Operating temperature		-55	150	°C
Lead temperature (soldering, 10 s)		300		°C
Junction temperature		150		°C
T <sub>stg</sub>	Storage temperature	-55	150	°C

- (1) Stresses beyond those listed under *Absolute Maximum Ratings* may cause permanent damage to the device. These are stress ratings only, which do not imply functional operation of the device at these or any other conditions beyond those indicated under *Recommended Operating Conditions*. Exposure to absolute-maximum-rated conditions for extended periods may affect device reliability.
- (2) Input terminals are diode-clamped to the power-supply rails. Input signals that can swing more than 0.3 V beyond the supply rails should be current-limited to 10 mA or less.
- (3) Short-circuit to ground, one amplifier per package.

### 6.2 ESD Ratings

			VALUE	UNIT
<b>OPA350, OPA2350, OPA4350 (ALL PACKAGE TYPES)</b>				
V <sub>(ESD)</sub>	Electrostatic discharge	Human-body model (HBM), per ANSI/ESDA/JEDEC JS-001 <sup>(1)</sup>	±1000	V
<b>OPA350, OPA2350, OPA4350 (SOIC PACKAGES ONLY)</b>				
V <sub>(ESD)</sub>	Electrostatic discharge	Charged-device model (CDM), per JEDEC specification JESD22-C101 <sup>(2)</sup>	±1500	V

- (1) JEDEC document JEP155 states that 500-V HBM allows safe manufacturing with a standard ESD control process.
- (2) JEDEC document JEP157 states that 250-V CDM allows safe manufacturing with a standard ESD control process.

### 6.3 Recommended Operating Conditions

over operating free-air temperature range (unless otherwise noted)

	MIN	NOM	MAX	UNIT
Power supply voltage, (V+)-(V-)	2.7 (±1.35)	5 (±2.5)	5.5 (±2.75)	V
Specified temperature	-40	25	85	°C
Operating temperature	-55	25	150	°C

## 6.4 Thermal Information: OPA350 and OPA2350

THERMAL METRIC <sup>(1)</sup>		OPA350, OPA2350			UNIT
		DGK (VSSOP)	P (PDIP)	D (SOIC)	
		8 PINS	8 PINS	8 PINS	
$R_{\theta JA}$	Junction-to-ambient thermal resistance	169.2	53.1	140.1	°C/W
$R_{\theta JC(top)}$	Junction-to-case (top) thermal resistance	62.8	42.5	89.8	°C/W
$R_{\theta JB}$	Junction-to-board thermal resistance	89.8	30.3	80.6	°C/W
$\Psi_{JT}$	Junction-to-top characterization parameter	7.5	19.7	28.7	°C/W
$\Psi_{JB}$	Junction-to-board characterization parameter	88.2	30.2	80.1	°C/W
$R_{\theta JC(bot)}$	Junction-to-case (bottom) thermal resistance	N/A	N/A	N/A	°C/W

(1) For more information about traditional and new thermal metrics, see the *IC Package Thermal Metrics* application report, [SPRA953](#).

## 6.5 Thermal Information: OPA4350

THERMAL METRIC <sup>(1)</sup>		OPA4350		UNIT
		D (SOIC)	DBQ (SSOP)	
		14 PINS	16 PINS	
$R_{\theta JA}$	Junction-to-ambient thermal resistance	83.8	115.8	°C/W
$R_{\theta JC(top)}$	Junction-to-case (top) thermal resistance	70.7	67	°C/W
$R_{\theta JB}$	Junction-to-board thermal resistance	59.5	58.3	°C/W
$\Psi_{JT}$	Junction-to-top characterization parameter	11.6	19.9	°C/W
$\Psi_{JB}$	Junction-to-board characterization parameter	37.7	57.9	°C/W
$R_{\theta JC(bot)}$	Junction-to-case (bottom) thermal resistance	N/A	N/A	°C/W

(1) For more information about traditional and new thermal metrics, see the *Semiconductor and IC Package Thermal Metrics* application report, [SPRA953](#).

## 6.6 Electrical Characteristics

 $V_S = 2.7\text{ V to }5.5\text{ V}$ ; All specifications at  $T_A = 25^\circ\text{C}$ ,  $R_L = 1\text{ k}\Omega$  connected to  $V_S/2$  and  $V_{OUT} = V_S/2$ , unless otherwise noted.

PARAMETER		TEST CONDITIONS	MIN	TYP <sup>(1)</sup>	MAX	UNIT
<b>OFFSET VOLTAGE</b>						
$V_{OS}$	Input offset voltage	$V_S = 5\text{ V}$		$\pm 150$	$\pm 500$	$\mu\text{V}$
		$T_A = -40^\circ\text{C to }85^\circ\text{C}$			$\pm 1$	$\text{mV}$
	vs Temperature	$T_A = -40^\circ\text{C to }85^\circ\text{C}$		$\pm 4$		$\mu\text{V}/^\circ\text{C}$
PSRR	vs Power-supply rejection ratio	$V_S = 2.7\text{ V to }5.5\text{ V}$ , $V_{CM} = 0\text{ V}$		40	150	$\mu\text{V}/\text{V}$
					175	
	Channel separation (dual, quad)	DC		0.15		$\mu\text{V}/\text{V}$
<b>INPUT BIAS CURRENT</b>						
$I_B$	Input bias current			$\pm 0.5$	$\pm 10$	$\text{pA}$
		vs Temperature		See <a href="#">Typical Characteristics</a>		
$I_{OS}$	Input offset current			$\pm 0.5$	$\pm 10$	$\text{pA}$
<b>NOISE</b>						
	Input voltage noise, $f = 100\text{ Hz to }400\text{ kHz}$			4		$\mu\text{Vrms}$
$e_n$	Input voltage noise density, $f = 10\text{ kHz}$			7		$\text{nV}/\sqrt{\text{Hz}}$
	Input current noise density, $f = 100\text{ kHz}$			5		$\text{nV}/\sqrt{\text{Hz}}$
$i_n$	Current noise density, $f = 10\text{ kHz}$			4		$\text{fA}/\sqrt{\text{Hz}}$
<b>INPUT VOLTAGE RANGE</b>						
$V_{CM}$	Common-mode voltage range	$T_A = -40^\circ\text{C to }85^\circ\text{C}$	-0.1		$(V+) + 0.1$	V
CMRR	Common-mode rejection ratio	$V_S = 2.7\text{ V}$ , $-0.1\text{ V} < V_{CM} < 2.8\text{ V}$	66	84		dB
		$V_S = 5.5\text{ V}$ , $-0.1\text{ V} < V_{CM} < 5.6\text{ V}$	74	90		
		$T_A = -40^\circ\text{C to }85^\circ\text{C}$ , $V_S = 5.5\text{ V}$ , $-0.1\text{ V} < V_{CM} < 5.6\text{ V}$	74			
<b>INPUT IMPEDANCE</b>						
	Differential			$10^{13} \parallel 2.5$		$\Omega \parallel \text{pF}$
	Common-mode			$10^{13} \parallel 6.5$		$\Omega \parallel \text{pF}$
<b>OPEN-LOOP GAIN</b>						
$A_{OL}$	Open-loop voltage gain	$T_A = -40^\circ\text{C to }85^\circ\text{C}$	$R_L = 10\text{ k}\Omega$ , $50\text{ mV} < V_O < (V+) - 50\text{ mV}$	100	122	dB
			$R_L = 10\text{ k}\Omega$ , $50\text{ mV} < V_O < (V+) - 50\text{ mV}$	100		
			$R_L = 1\text{ k}\Omega$ , $200\text{ mV} < V_O < (V+) - 200\text{ mV}$	100	120	
			$R_L = 1\text{ k}\Omega$ , $200\text{ mV} < V_O < (V+) - 200\text{ mV}$	100		
<b>FREQUENCY RESPONSE (<math>C_L = 100\text{ pF}</math>)</b>						
GBW	Gain-bandwidth product	$G = 1$		38		MHz
SR	Slew rate	$G = 1$		22		$\text{V}/\mu\text{s}$
	Settling time	$G = \pm 1$ , 2-V Step	0.1%	0.22		$\mu\text{s}$
			0.01%	0.5		
	Overload recovery time	$V_{IN} \times G = V_S$		0.1		$\mu\text{s}$
THD+N	Total harmonic distortion + noise	$R_L = 600\ \Omega$ , $V_O = 2.5\text{ V}_{pp}$ <sup>(2)</sup> , $G = 1$ , $f = 1\text{ kHz}$		0.0006%		
	Differential gain error	$G = 2$ , $R_L = 600\ \Omega$ , $V_O = 1.4\text{ V}$ <sup>(3)</sup>		0.17%		
	Differential phase error	$G = 2$ , $R_L = 600\ \Omega$ , $V_O = 1.4\text{ V}$ <sup>(3)</sup>		0.17		$^\circ$
<b>OUTPUT</b>						
$V_{OUT}$	Voltage output swing from rail <sup>(4)</sup>	$T_A = -40^\circ\text{C to }85^\circ\text{C}$	$R_L = 10\text{ k}\Omega$ , $A_{OL} \geq 100\text{ dB}$	10	50	mV
			$R_L = 10\text{ k}\Omega$ , $A_{OL} \geq 100\text{ dB}$		50	
			$R_L = 1\text{ k}\Omega$ , $A_{OL} \geq 100\text{ dB}$		25	
$I_{OUT}$	Output current			$\pm 40$ <sup>(5)</sup>		mA
$I_{SC}$	short circuit current			$\pm 80$		mA
$C_{LOAD}$	Capacitive load drive			See <a href="#">Typical Characteristics</a>		

 (1)  $V_S = 5\text{ V}$ 

 (2)  $V_{OUT} = 0.25\text{ V to }2.75\text{ V}$ 

 (3) NTSC signal generator used. See [Figure 31](#) for test circuit.

(4) Output voltage swings are measured between the output and power supply rails.

 (5) See [Figure 17](#).

**Electrical Characteristics (continued)**
 $V_S = 2.7\text{ V to }5.5\text{ V}$ ; All specifications at  $T_A = 25^\circ\text{C}$ ,  $R_L = 1\text{ k}\Omega$  connected to  $V_S/2$  and  $V_{OUT} = V_S/2$ , unless otherwise noted.

PARAMETER		TEST CONDITIONS	MIN	TYP <sup>(1)</sup>	MAX	UNIT
<b>POWER SUPPLY</b>						
$V_S$	Operating voltage range	$T_A = -40^\circ\text{C to }85^\circ\text{C}$	2.7		5.5	V
	Minimum operating voltage			2.5		V
$I_Q$	Quiescent current (per amplifier)	$T_A = -40^\circ\text{C to }85^\circ\text{C}$	$I_O = 0$		5.2	7.5
						8.5
<b>TEMPERATURE RANGE</b>						
	Specified range		-40		85	$^\circ\text{C}$
	Operating range		-55		150	$^\circ\text{C}$

## 6.7 Typical Characteristics

All specifications at  $T_A = 25^\circ\text{C}$ ,  $V_S = 5\text{ V}$ , and  $R_L = 1\text{ k}\Omega$  connected to  $V_S/2$ , unless otherwise noted.

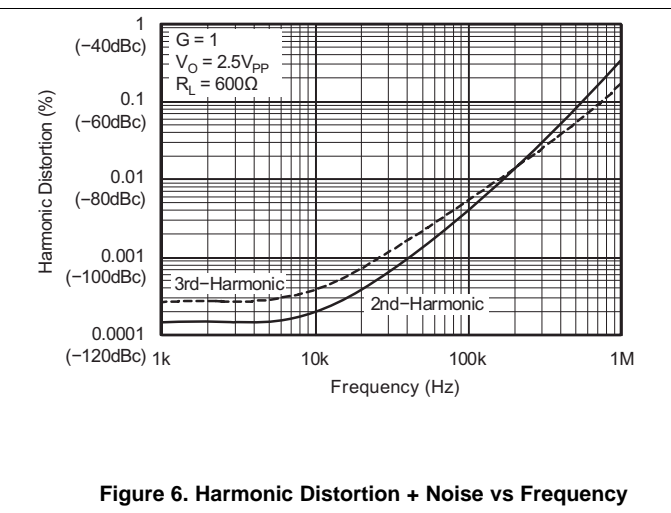
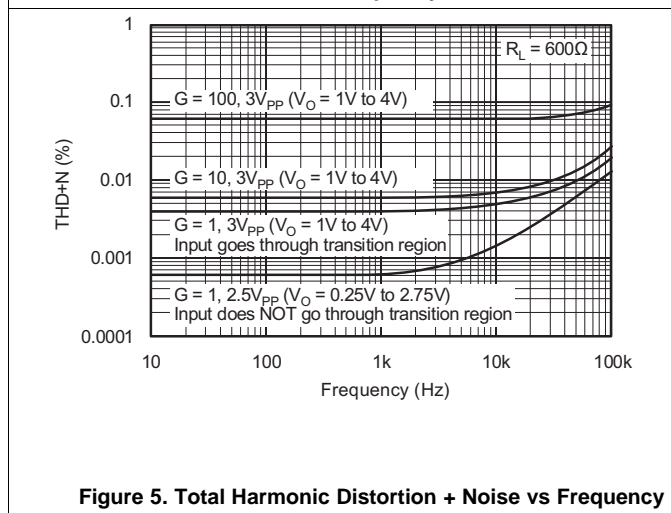
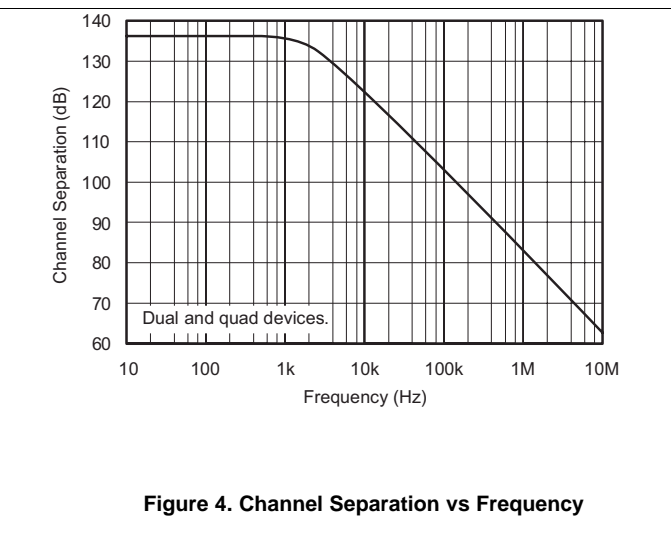
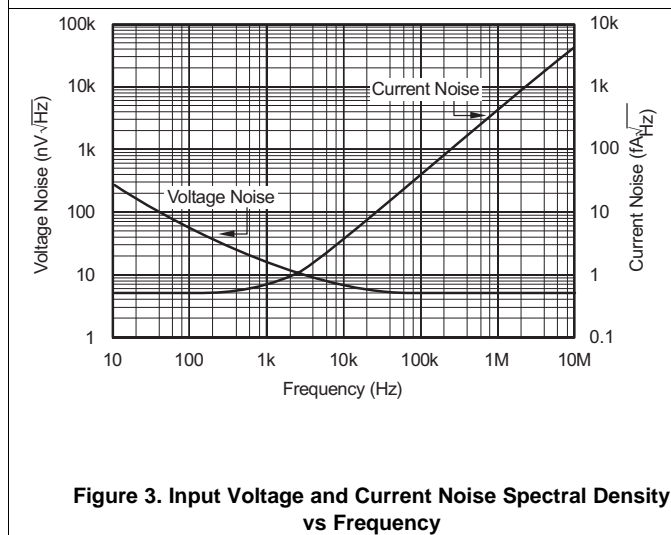
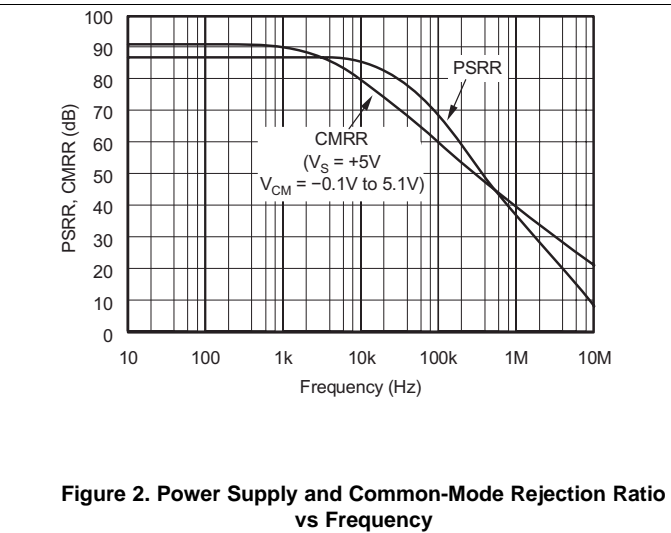
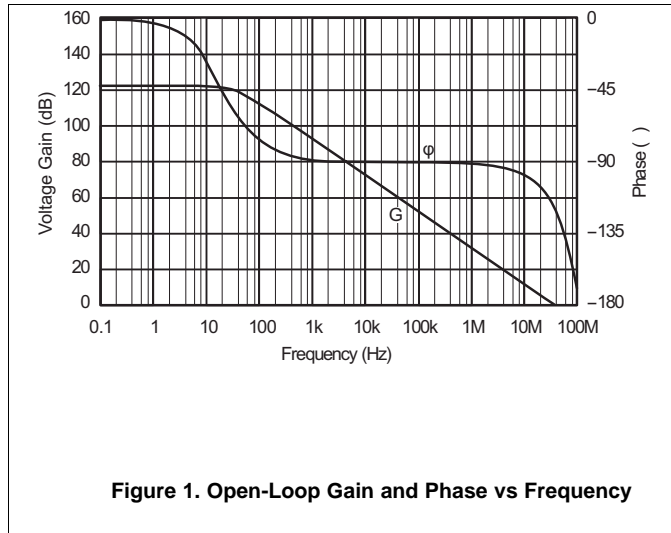

**Typical Characteristics (continued)**

All specifications at  $T_A = 25^\circ\text{C}$ ,  $V_S = 5\text{ V}$ , and  $R_L = 1\text{ k}\Omega$  connected to  $V_S/2$ , unless otherwise noted.

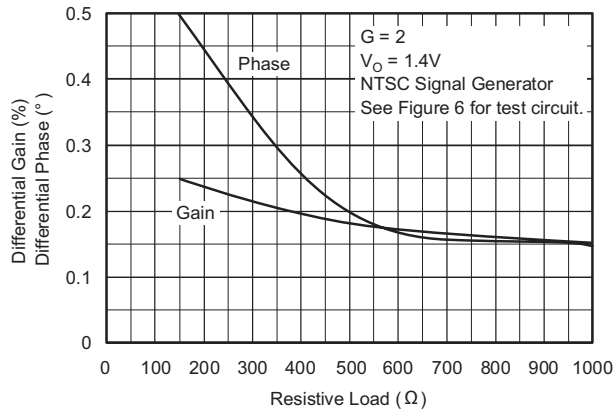

**Figure 7. Differential Gain and Phase vs Resistive Load**

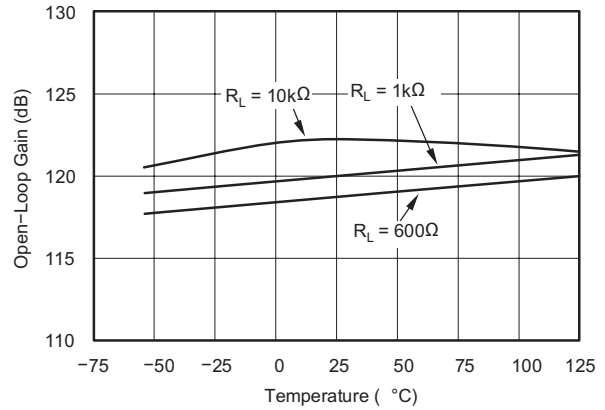

**Figure 8. Open-Loop Gain vs Temperature**

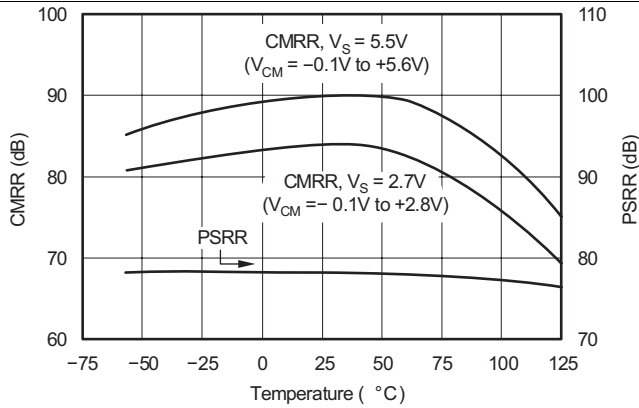

**Figure 9. Common-Mode and Power-Supply Rejection Ratio vs Temperature**

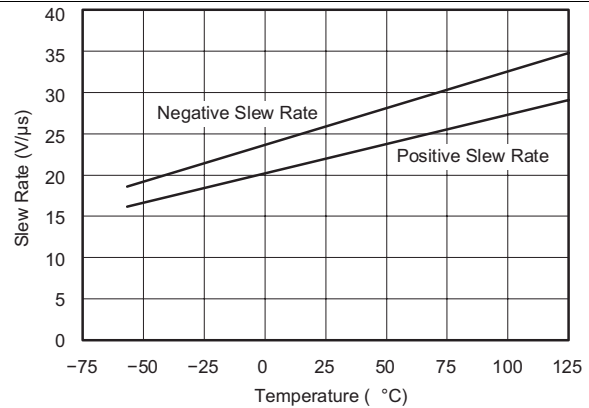

**Figure 10. Slew Rate vs Temperature**

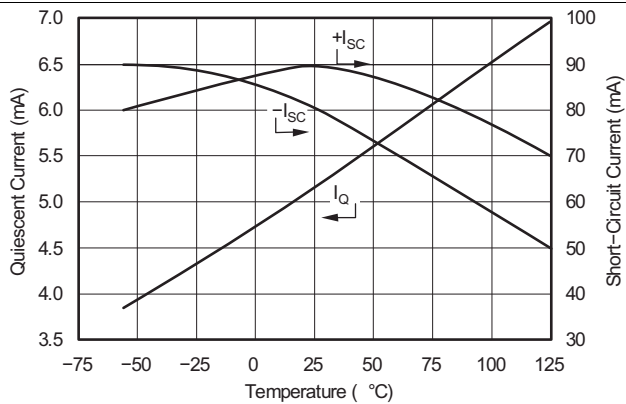

**Figure 11. Quiescent Current and short circuit Current vs Temperature**

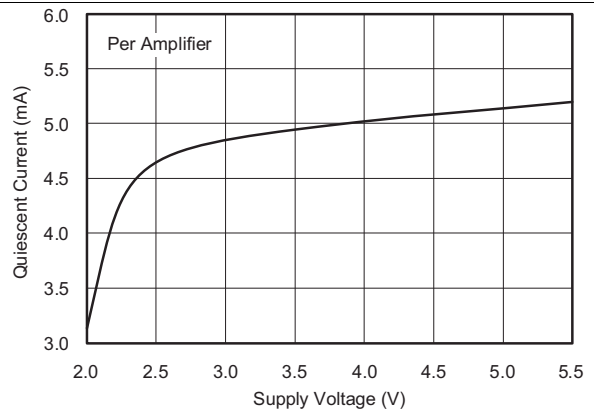

**Figure 12. Quiescent Current vs Supply Voltage**

### Typical Characteristics (continued)

All specifications at  $T_A = 25^\circ\text{C}$ ,  $V_S = 5\text{ V}$ , and  $R_L = 1\text{ k}\Omega$  connected to  $V_S/2$ , unless otherwise noted.

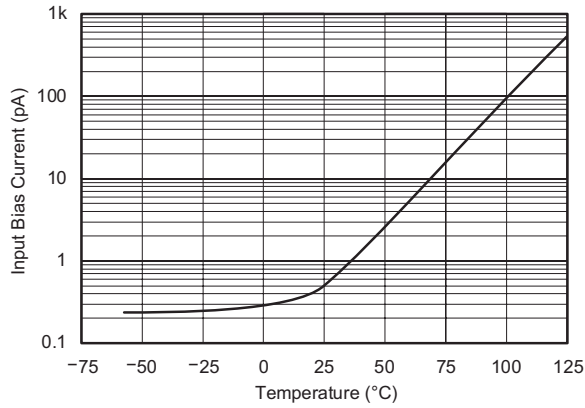

Figure 13. Input Bias Current vs Temperature

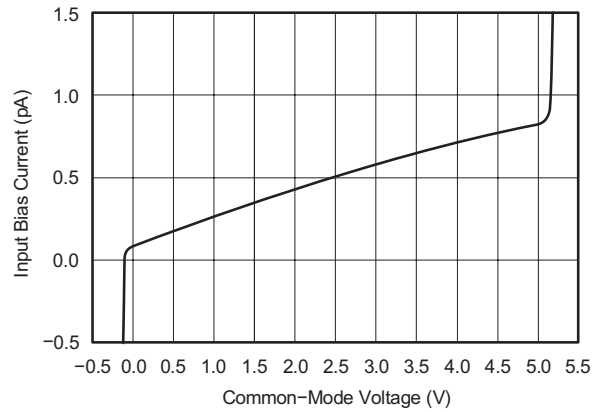

Figure 14. Input Bias Current vs Input Common-Mode Voltage

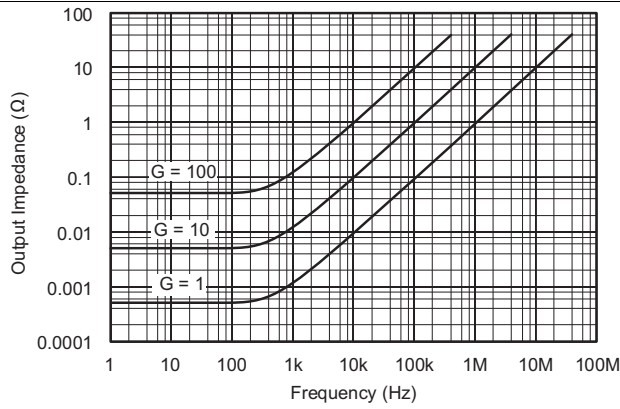

Figure 15. Closed-Loop Output Impedance vs Frequency

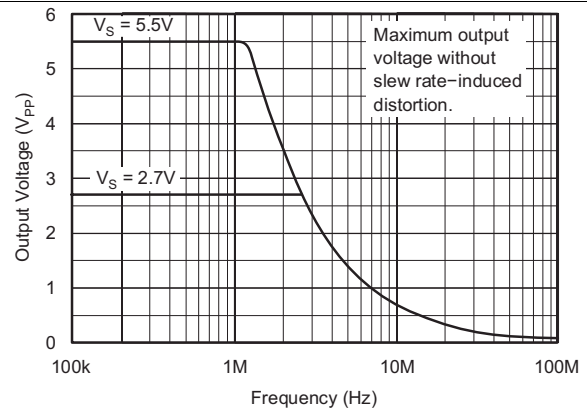

Figure 16. Maximum Output Voltage vs Frequency

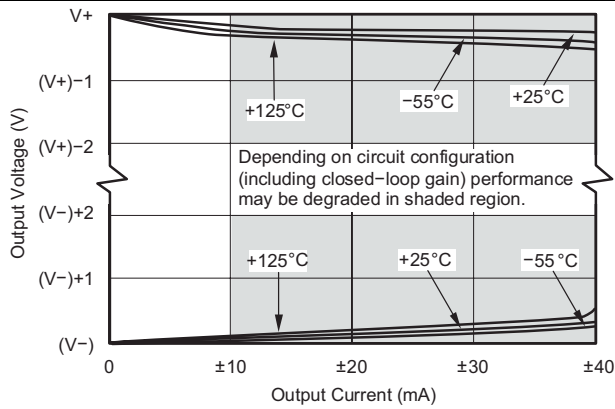

Figure 17. Output Voltage Swing vs Output Current

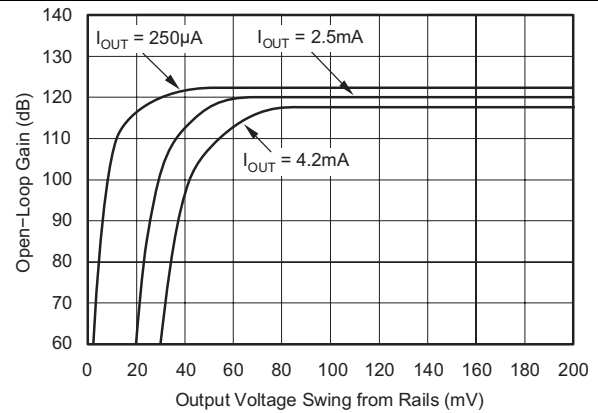
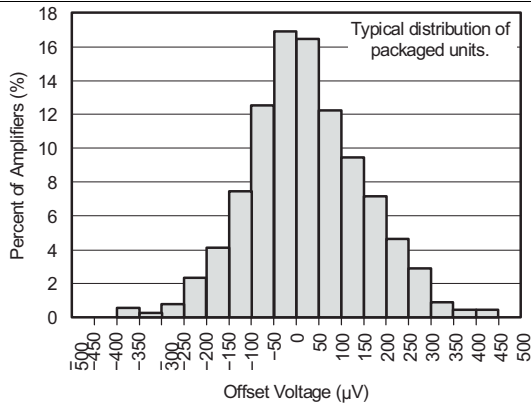

Figure 18. Open-Loop Gain vs Output Voltage Swing

**Typical Characteristics (continued)**

All specifications at  $T_A = 25^\circ\text{C}$ ,  $V_S = 5\text{ V}$ , and  $R_L = 1\text{ k}\Omega$  connected to  $V_S/2$ , unless otherwise noted.



**Figure 19. Offset Voltage Production Distribution**

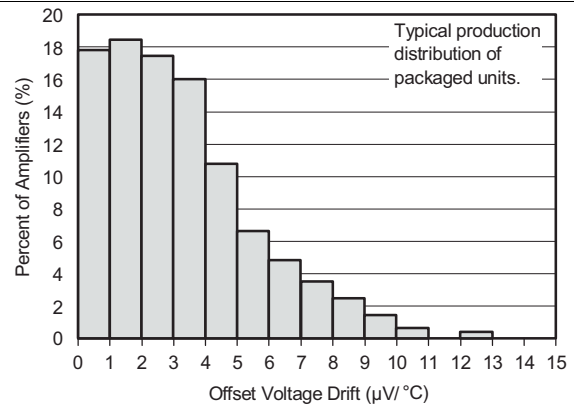

**Figure 20. Offset Voltage Drift Production Distribution**

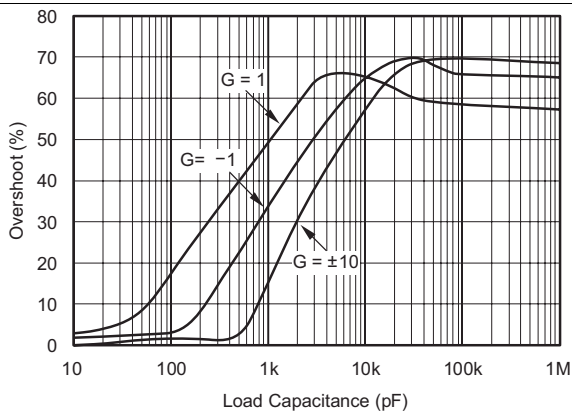

**Figure 21. Small-Signal Overshoot vs Load Capacitance**

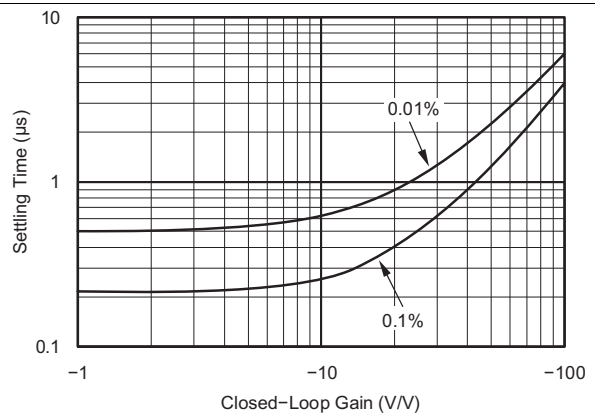

**Figure 22. Settling Time vs Closed-Loop Gain**

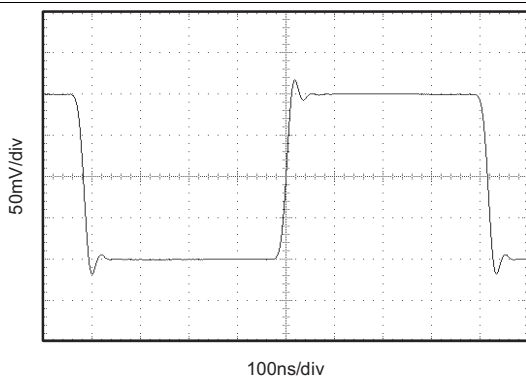

**Figure 23. Small-Signal Step Response**  
 $C_L = 100\text{ pF}$

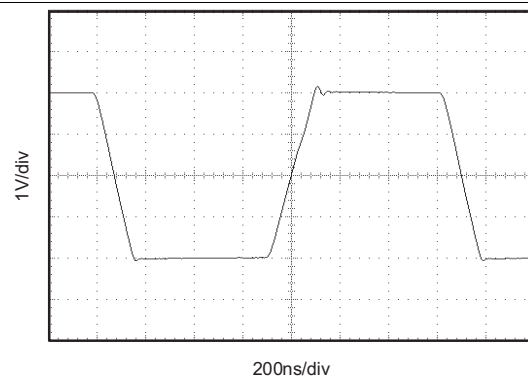

**Figure 24. Large-Signal Step Response**  
 $C_L = 100\text{ pF}$

## 7 Detailed Description

### 7.1 Overview

The OPA350 series rail-to-rail CMOS operational amplifiers are optimized for low voltage, single-supply operation. Rail-to-rail input and output, low noise (5 nV/√Hz), and high speed operation (38 MHz, 22 V/μs) make the amplifiers ideal for driving sampling Analog-to-Digital (A/D) converters. They are also suited for cell phone PA control loops and video processing (75-Ω drive capability), as well as audio and general purpose applications. Single, dual, and quad versions have identical specifications for maximum design flexibility.

### 7.2 Functional Block Diagram



### 7.3 Feature Description

The OPA350 series of operational amplifiers (op amps) are fabricated on a state-of-the-art 0.6 micron CMOS process. They are unity-gain stable and suitable for a wide range of general purpose applications. Rail-to-rail input and output make them ideal for driving sampling A/D converters. They are also suited for controlling the output power in cell phones. These applications often require high speed and low noise. In addition, the OPA350 series offers a low-cost solution for general-purpose and consumer video applications (75-Ω drive capability).

Excellent AC performance makes the OPA350 series suited for audio applications. Their bandwidth, slew rate, low noise (5 nV/√Hz), low THD (0.0006%), and small package options are ideal for these applications. The class AB output stage is capable of driving 600-Ω loads connected to any point between V+ and ground.

Rail-to-rail input and output swing significantly increases dynamic range, especially in low voltage supply applications. [Figure 25](#) shows the input and output waveforms for the OPA350 in unity-gain configuration. Operation is from a single 5-V supply with a 1-kΩ load connected to  $V_S/2$ . The input is a 5  $V_{PP}$  sinusoid. Output voltage swing is approximately 4.95  $V_{PP}$ .

Power supply pins should be bypassed with 0.01-μF ceramic capacitors.

## Feature Description (continued)



**Figure 25. Rail-to-Rail Input and Output**

### 7.3.1 Operating Voltage

OPA350 series operational amplifiers are fully specified from 2.7 V to 5.5 V. Supply voltage may range from 2.5 V to 5.5 V. Parameters are tested over the specified supply range: a feature of the OPA350 series. In addition, many specifications apply from  $-40^{\circ}\text{C}$  to  $85^{\circ}\text{C}$ . Most behavior remains virtually unchanged throughout the full operating voltage range. Parameters that vary significantly with operating voltage or temperature are shown in [Typical Characteristics](#).

### 7.3.2 Rail-to-Rail Input

The tested input common-mode voltage range of the OPA350 series extends 100 mV beyond the supply rails. This is achieved with a complementary input stage: an N-channel input-differential pair in parallel with a P-channel differential pair, as shown in [Figure 26](#). The N-channel pair is active for input voltages close to the positive rail, typically  $(V+) - 1.8\text{ V}$  to 100 mV above the positive supply, while the P-channel pair is on for inputs from 100 mV below the negative supply to approximately  $(V+) - 1.8\text{ V}$ . There is a small transition region, typically  $(V+) - 2\text{ V}$  to  $(V+) - 1.6\text{ V}$ , in which both pairs are on. This 400-mV transition region can vary  $\pm 400\text{ mV}$  with process variation. Thus, the transition region (both input stages on) can range from  $(V+) - 2.4\text{ V}$  to  $(V+) - 2\text{ V}$  on the low end, up to  $(V+) - 1.6\text{ V}$  to  $(V+) - 1.2\text{ V}$  on the high end.

**Feature Description (continued)**

**Figure 26. Simplified Schematic**

OPA350 series operational amplifiers are laser-trimmed to reduce offset voltage difference between the N-channel and P-channel input stages, resulting in improved common-mode rejection and a smooth transition between the N-channel pair and the P-channel pair. However, within the 400-mV transition region PSRR, CMRR, offset voltage, offset drift, and THD may be degraded compared to operation outside this region.

A double-folded cascode adds the signal from the two input pairs and presents a differential signal to the class AB output stage. Normally, input bias current is approximately 500 fA. However, large inputs (greater than 300 mV beyond the supply rails) can turn on the input protection diodes, causing excessive current to flow in or out of the input pins. Momentary voltages greater than 300 mV beyond the power supply can be tolerated if the current on the input pins is limited to 10 mA. This is easily accomplished with an input resistor, as shown in [Figure 27](#). Many input signals are inherently current-limited to less than 10 mA; therefore, a limiting resistor is not required.

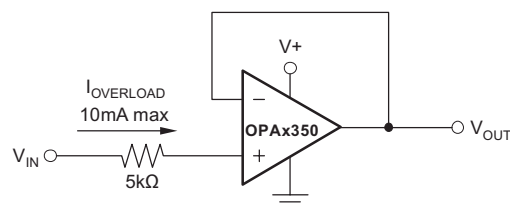
**Figure 27. Input Current Protection for Voltages Exceeding the Supply Voltage**
**7.3.3 Rail-to-Rail Output**

A class AB output stage with common-source transistors achieves rail-to-rail output. For light resistive loads ( $>10$  k $\Omega$ ), the output voltage swing is typically ten millivolts from the supply rails. With heavier resistive loads (600  $\Omega$  to 10 k $\Omega$ ), the output can swing to within a few tens of millivolts from the supply rails and maintain high open-loop gain. See [Figure 17](#) and [Figure 18](#) for more information.

## Feature Description (continued)

### 7.3.4 Capacitive Load and Stability

OPA350 series operational amplifiers can drive a wide range of capacitive loads. However, all operational amplifiers under certain conditions may become unstable. Operational amplifier configuration, gain, and load value are just a few of the factors to consider when determining stability. An operational amplifier in unity-gain configuration is the most susceptible to the effects of capacitive load. The capacitive load reacts with the output impedance of the operational amplifier, along with any additional load resistance, to create a pole in the small-signal response that degrades the phase margin.

In unity gain, OPA350 series operational amplifiers perform well with large capacitive loads. Increasing gain enhances the ability of the amplifier to drive more capacitance. [Figure 21](#) shows performance with a 1-k $\Omega$  resistive load. Increasing load resistance improves capacitive load drive capability.

### 7.3.5 Driving A/D Converters

OPA350 series operational amplifiers are optimized for driving medium speed (up to 500 kHz) sampling A/D converters, and also offer excellent performance for higher speed converters. The OPA350 series provides an effective means of buffering the input capacitance of the A/D and resulting charge injection while providing signal gain.

[Figure 28](#) shows the OPA350 driving an ADS7861. The ADS7861 is a dual, 500 kHz, 12-bit sampling converter in the tiny SSOP-24 package. When used with the miniature package options of the OPA350 series, the combination is ideal for space-limited applications. For further information, consult the ADS7861 data sheet, *Dual, 500kSPS, 12-Bit, 2 + 2 Channel, Simultaneous Sampling ANALOG-TO-DIGITAL CONVERTER (SBAS110)*.

**Feature Description (continued)**

**Figure 28. OPA4350 Driving Sampling A/D Converter**
**7.3.6 Output Impedance**

The low-frequency open-loop output impedance of the common-source output stage of the OPA350 is approximately 1 k $\Omega$ . When the operational amplifier is connected with feedback, this value is reduced significantly by the loop gain of the operational amplifier. For example, with 122 dB of open-loop gain, the output impedance is reduced in unity-gain to less than 0.001  $\Omega$ . For each decade rise in the closed-loop gain, the loop gain is reduced by the same amount which results in a ten-fold increase in effective output impedance (see Figure 15).

At higher frequencies, the output impedance rises as the open-loop gain of the operational amplifier drops. However, at these frequencies the output also becomes capacitive due to parasitic capacitance. This prevents the output impedance from becoming too high, which can cause stability problems when driving capacitive loads. The OPA350 has excellent capacitive load drive capability for an operational amplifier with its bandwidth.

## 7.4 Device Functional Modes

The OPAx350 has a single functional mode and is operational when the power-supply voltage is greater than 2.7 V ( $\pm 1.35$  V). The maximum power supply voltage for the OPAx350 is 5.5V ( $\pm 2.75$  V).

## 8 Application and Implementation

### NOTE

Information in the following applications sections is not part of the TI component specification, and TI does not warrant its accuracy or completeness. TI's customers are responsible for determining suitability of components for their purposes. Customers should validate and test their design implementation to confirm system functionality.

### 8.1 Application Information

Low pass filters are commonly employed in signal processing applications to reduce noise and prevent aliasing. The OPAx350 are ideally suited to construct high speed, high precision active filters. [Figure 29](#) illustrates a second order low pass filter commonly encountered in signal processing applications.

### 8.2 Typical Applications

#### 8.2.1 Second Order Low Pass Filter

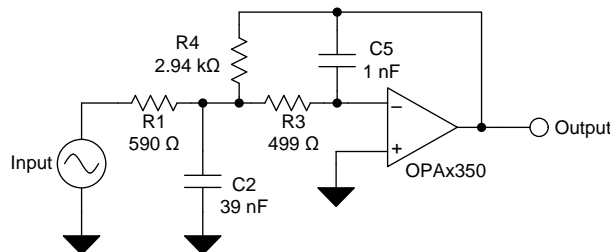

**Figure 29. Second Order Low Pass Filter**

##### 8.2.1.1 Design Requirements

Use the following parameters for this design example:

- Gain = 5 V/V (inverting gain).
- Low pass cutoff frequency = 25 kHz.
- Second order Chebyshev filter response with 3-dB gain peaking in the passband.

##### 8.2.1.2 Detailed Design Procedure

The infinite-gain multiple-feedback circuit for a low-pass network function is shown in [Equation 1](#). Use [Equation 2](#) to calculate the voltage transfer function.

$$\frac{\text{Output}}{\text{Input}}(s) = \frac{-1/R_1 R_3 C_2 C_5}{s^2 + (s/C_2)(1/R_1 + 1/R_3 + 1/R_4) + 1/R_3 R_4 C_2 C_5} \quad (1)$$

This circuit produces a signal inversion. For this circuit the gain at DC and the low pass cutoff frequency can be calculated using [Equation 2](#).

$$\text{Gain} = \frac{R_4}{R_1}$$

$$f_c = \frac{1}{2\pi} \sqrt{1/R_3 R_4 C_2 C_5} \quad (2)$$

Software tools are readily available to simplify filter design. [WEBENCH® Filter Designer](#) is a simple, powerful, and easy-to-use active filter design program. The WEBENCH Filter Designer lets you create optimized filter designs using a selection of TI operational amplifiers and passive components from TI's vendor partners. Available as a web based tool from the WEBENCH® Design Center, WEBENCH® Filter Designer allows you to design, optimize, and simulate complete multi-stage active filter solutions within minutes.

## Typical Applications (continued)

### 8.2.1.3 Application Curve

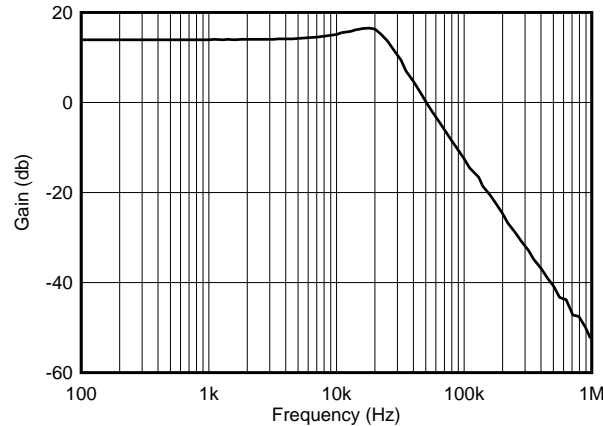

Figure 30. OPAx350 2nd Order 25-kHz, Chebyshev, Low-Pass Filter

### 8.2.2 Single-Supply Video Line Driver

Figure 31 shows a circuit for a single supply,  $G = 2$  composite video line driver. The synchronized outputs of a composite video line driver extend below ground. As shown, the input to the operational amplifier should be AC-coupled and shifted positively to provide adequate signal swing to account for these negative signals in a single-supply configuration.

The input is terminated with a  $75\text{-}\Omega$  resistor and AC-coupled with a  $47\text{-}\mu\text{F}$  capacitor to a voltage divider that provides the DC bias point to the input. In Figure 31, this point is approximately  $(V^-) + 1.7\text{ V}$ . Setting the optimal bias point requires some understanding of the nature of composite video signals. For best performance, avoid the distortion caused by the transition region of the complementary input stage of the OPA350. See the discussion of rail-to-rail input in [Rail-to-Rail Input](#).

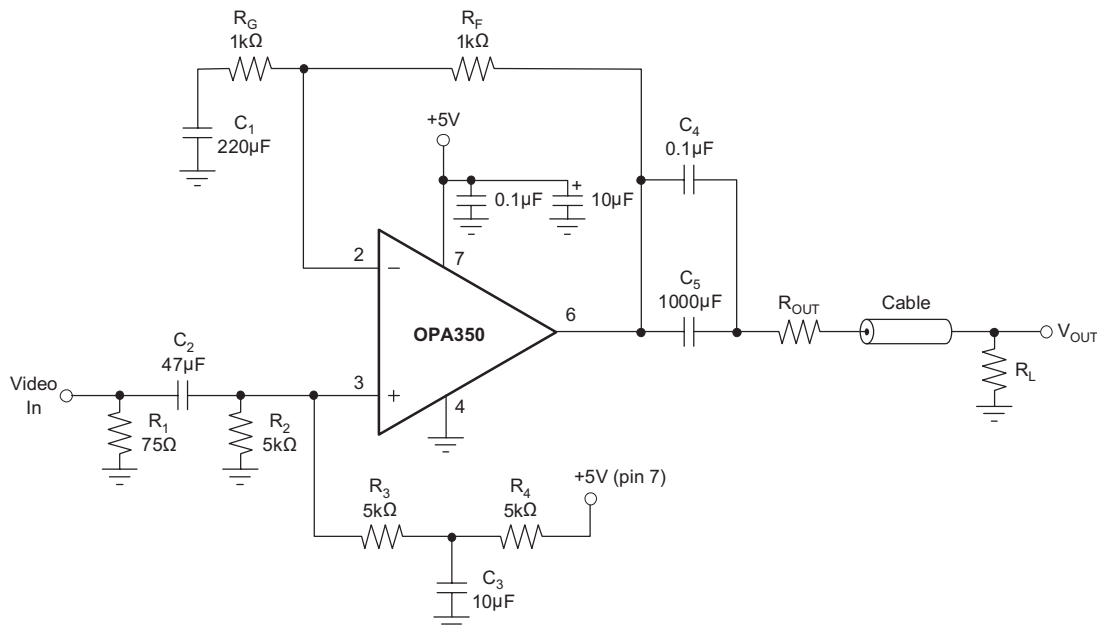

Figure 31. Single-Supply Video Line Driver

## Typical Applications (continued)

### 8.2.3 Adding a Feedback Capacitor to Improve Response

For optimum settling time and stability with high-impedance feedback networks, it may be necessary to add a feedback capacitor across the feedback resistor,  $R_F$ , as shown in Figure 32. This capacitor compensates for the zero created by the feedback network impedance and the input capacitance of the OPA350 (and any parasitic layout capacitance). The effect becomes more significant with higher impedance networks.



Where  $C_{IN}$  is equal to the OPA350's input capacitance (approximately 9 pF) plus any parasitic layout capacitance.

**Figure 32. Feedback Capacitor Improves Dynamic Performance**

A variable capacitor can be used for the feedback capacitor, because input capacitance may vary between operational amplifiers and layout capacitance is difficult to determine. For the circuit shown in Figure 32, the value of the variable feedback capacitor should be chosen so that the input resistance times the input capacitance of the OPA350 (typically 9 pF) plus the estimated parasitic layout capacitance equals the feedback capacitor times the feedback resistor:

$$R_{IN} \times C_{IN} = R_F \times C_F$$

where

- $C_{IN}$  is equal to the input capacitance of the OPA350 (sum of differential and common-mode) plus the layout capacitance. (3)

The capacitor can be varied until optimum performance is obtained.

### 8.2.4 Two Op-Amp Instrumentation Amplifier With Improved High-Frequency Common-Mode Rejection

The OPAx350 is well suited for high input impedance applications such as an instrumentation amplifier. The two amplifier configuration shown in Figure 33 rejects any common mode signals and senses the small differential input voltage developed by the resistive bridge. The voltage reference sets the output to 2.5 V when the differential signal developed by the bridge is zero. The high common mode rejection versus frequency response of the OPAx350, rejects and common mode noise that may be coupled into the bridge circuit from the bridge excitation source. The gain of the circuit is determined by  $R_G$  according to the equation shown in Figure 33.

Typical Applications (continued)

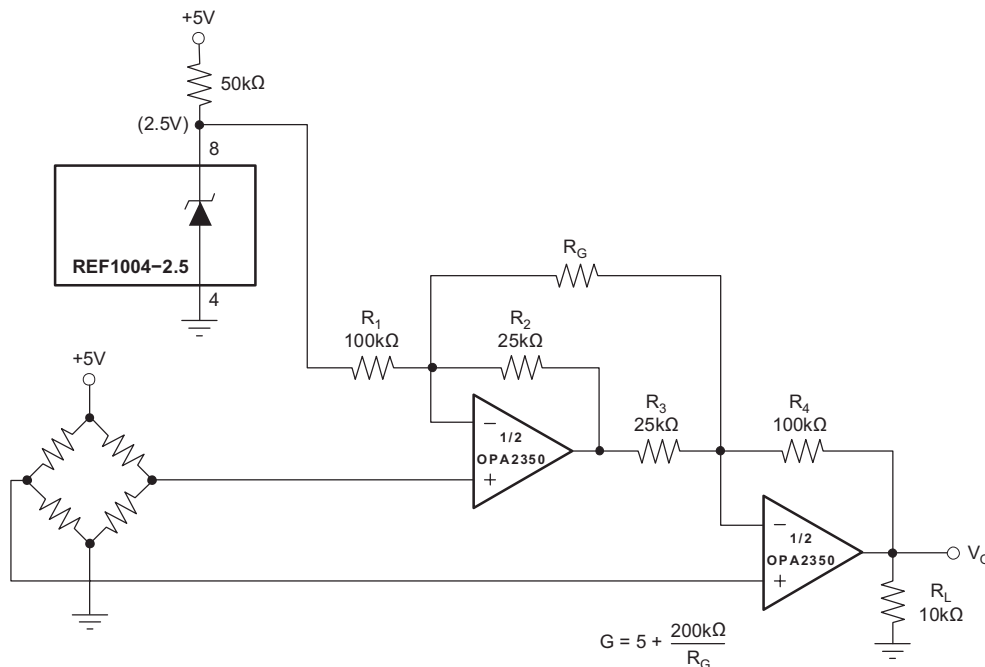

Figure 33. Two Op-Amp Instrumentation Amplifier With Improved High-Frequency Common-Mode Rejection Schematic

8.2.5 10-kHz High-Pass Filter

High-pass filters are used to reject DC signals and low-frequency time varying signals such as drift versus temperature. Figure 34 illustrates a high-pass filter with a 10 kHz low-frequency cutoff frequency.

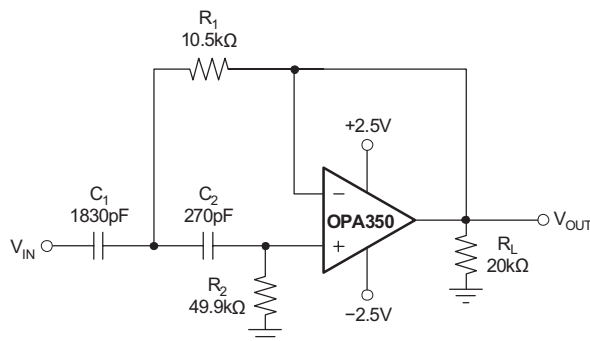

Figure 34. 10-kHz High-Pass Filter

## 9 Power Supply Recommendations

The OPAx350 are specified for operation from 2.7 V to 5.5 V ( $\pm 1.35$  V to  $\pm 2.75$  V); many specifications apply from  $-40^{\circ}\text{C}$  to  $85^{\circ}\text{C}$ . Parameters that can exhibit significant variance with regard to operating voltage or temperature are presented in the [Typical Characteristics](#).

## 10 Layout

### 10.1 Layout Guidelines

For best operational performance of the device, use good PCB layout practices, including:

- Noise can propagate into analog circuitry through the power pins of the circuit as a whole and operational amplifier itself. Bypass capacitors are used to reduce the coupled noise by providing low-impedance power sources local to the analog circuitry.
  - Connect low-ESR, 0.1- $\mu\text{F}$  ceramic bypass capacitors between each supply pin and ground, placed as close to the device as possible. A single bypass capacitor from V+ to ground is applicable for single-supply applications.
- Separate grounding for analog and digital portions of circuitry is one of the simplest and most-effective methods of noise suppression. One or more layers on multilayer PCBs are usually devoted to ground planes. A ground plane helps distribute heat and reduces EMI noise pickup. Make sure to physically separate digital and analog grounds paying attention to the flow of the ground current. For more detailed information, see *Circuit Board Layout Techniques* ([SLOA089](#)).
- To reduce parasitic coupling, run the input traces as far away from the supply or output traces as possible. If these traces cannot be kept separate, crossing the sensitive trace perpendicular is much better as opposed to in parallel with the noisy trace.
- Place the external components as close to the device as possible. As illustrated in [Figure 35](#), keeping RF and RG close to the inverting input minimizes parasitic capacitance.
- Keep the length of input traces as short as possible. Always remember that the input traces are the most sensitive part of the circuit.
- Consider a driven, low-impedance guard ring around the critical traces. A guard ring can significantly reduce leakage currents from nearby traces that are at different potentials.
- Cleaning the PCB following board assembly is recommended for best performance.
- Any precision integrated circuit may experience performance shifts due to moisture ingress into the plastic package. Following any aqueous PCB cleaning process, baking the PCB assembly is recommended to remove moisture introduced into the device packaging during the cleaning process. A low temperature, post cleaning bake at  $85^{\circ}\text{C}$  for 30 minutes is sufficient for most circumstances.

## 10.2 Layout Example

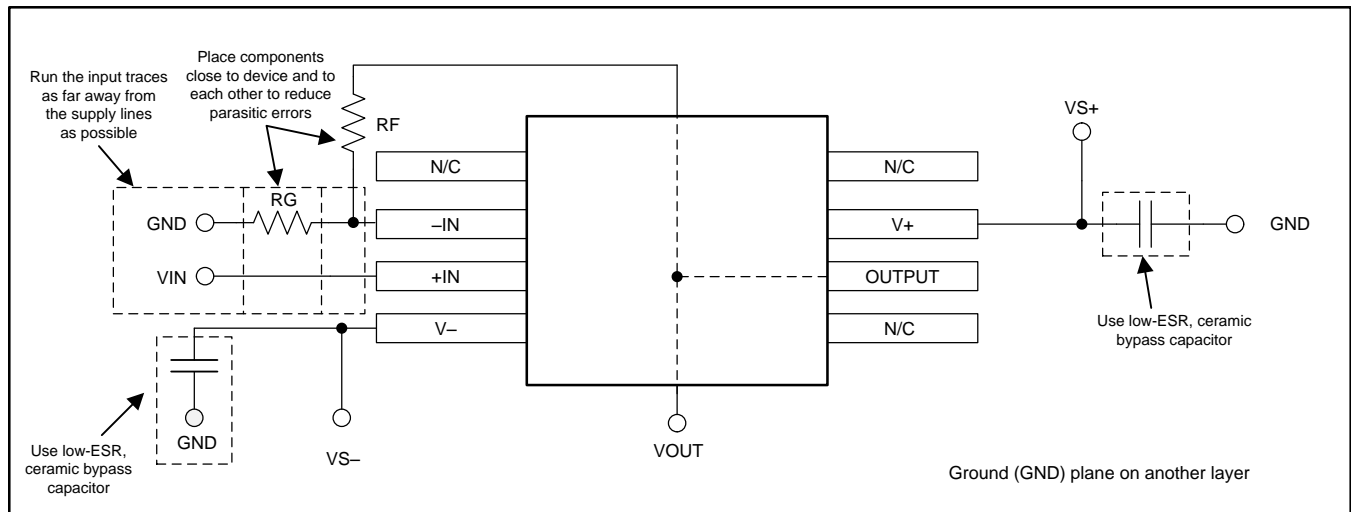
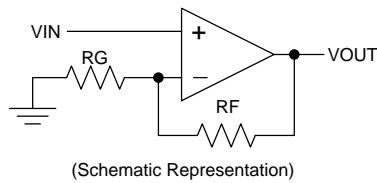

Figure 35. Operational Amplifier Board Layout for Noninverting Configuration

## 11 Device and Documentation Support

### 11.1 Device Support

#### 11.1.1 Development Support

##### 11.1.1.1 TINA-TI™ (Free Software Download)

TINA™ is a simple, powerful, and easy-to-use circuit simulation program based on a SPICE engine. TINA-TI™ is a free, fully-functional version of the TINA software, preloaded with a library of macro models in addition to a range of both passive and active models. TINA-TI provides all the conventional DC, transient, and frequency domain analysis of SPICE, as well as additional design capabilities.

Available as a [free download](#) from the Analog eLab Design Center, TINA-TI offers extensive post-processing capability that allows users to format results in a variety of ways. Virtual instruments offer the ability to select input waveforms and probe circuit nodes, voltages, and waveforms, creating a dynamic quick-start tool.

**WEBENCH® Filter Designer** is a simple, powerful, and easy-to-use active filter design program. The WEBENCH Filter Designer lets you create optimized filter designs using a selection of TI operational amplifiers and passive components from TI's vendor partners. Available as a web based tool from the WEBENCH® Design Center, WEBENCH® Filter Designer allows you to design, optimize, and simulate complete multi-stage active filter solutions within minutes.

---

#### NOTE

These files require that either the TINA software (from DesignSoft™) or TINA-TI software be installed. Download the free TINA-TI software from the [TINA-TI folder](#).

---

##### 11.1.1.2 TI Precision Designs

The OPA350 is featured in several TI Precision Designs, available online at <http://www.ti.com/ww/en/analog/precision-designs/>. TI Precision Designs are analog solutions created by TI's precision analog applications experts and offer the theory of operation, component selection, simulation, complete PCB schematic and layout, bill of materials, and measured performance of many useful circuits.

### 11.2 Documentation Support

#### 11.2.1 Related Documentation

For related documentation see the following:

- *Circuit Board Layout Techniques*, [SLOA089](#)
- *Op Amps for Everyone*, [SLOD006](#)
- *Compensate Transimpedance Amplifiers Intuitively*, [SBOS055](#)
- *Noise Analysis for High Speed op Amps*, [SBOA066](#)

### 11.3 Related Links

The table below lists quick access links. Categories include technical documents, support and community resources, tools and software, and quick access to sample or buy.

**Table 1. Related Links**

PARTS	PRODUCT FOLDER	SAMPLE & BUY	TECHNICAL DOCUMENTS	TOOLS & SOFTWARE	SUPPORT & COMMUNITY
OPA350	<a href="#">Click here</a>	<a href="#">Click here</a>	<a href="#">Click here</a>	<a href="#">Click here</a>	<a href="#">Click here</a>
OPA2350	<a href="#">Click here</a>	<a href="#">Click here</a>	<a href="#">Click here</a>	<a href="#">Click here</a>	<a href="#">Click here</a>
OPA4350	<a href="#">Click here</a>	<a href="#">Click here</a>	<a href="#">Click here</a>	<a href="#">Click here</a>	<a href="#">Click here</a>

## 11.4 Community Resources

The following links connect to TI community resources. Linked contents are provided "AS IS" by the respective contributors. They do not constitute TI specifications and do not necessarily reflect TI's views; see TI's [Terms of Use](#).

**TI E2E™ Online Community** *TI's Engineer-to-Engineer (E2E) Community*. Created to foster collaboration among engineers. At [e2e.ti.com](http://e2e.ti.com), you can ask questions, share knowledge, explore ideas and help solve problems with fellow engineers.

**Design Support** *TI's Design Support* Quickly find helpful E2E forums along with design support tools and contact information for technical support.

## 11.5 Trademarks

TINA-TI, E2E are trademarks of Texas Instruments.  
TINA, DesignSoft are trademarks of DesignSoft, Inc.  
All other trademarks are the property of their respective owners.

## 11.6 Electrostatic Discharge Caution



These devices have limited built-in ESD protection. The leads should be shorted together or the device placed in conductive foam during storage or handling to prevent electrostatic damage to the MOS gates.

## 11.7 Glossary

[SLYZ022](#) — *TI Glossary*.

This glossary lists and explains terms, acronyms, and definitions.

## 12 Mechanical, Packaging, and Orderable Information

The following pages include mechanical, packaging, and orderable information. This information is the most current data available for the designated devices. This data is subject to change without notice and revision of this document. For browser-based versions of this data sheet, refer to the left-hand navigation.

**PACKAGING INFORMATION**

Orderable Device	Status (1)	Package Type	Package Drawing	Pins	Package Qty	Eco Plan (2)	Lead finish/ Ball material (6)	MSL Peak Temp (3)	Op Temp (°C)	Device Marking (4/5)	Samples
OPA2350EA/250	ACTIVE	VSSOP	DGK	8	250	RoHS & Green	NIPDAUAG	Level-2-260C-1 YEAR	-40 to 85	D50	<a href="#">Samples</a>
OPA2350EA/250G4	ACTIVE	VSSOP	DGK	8	250	RoHS & Green	NIPDAUAG	Level-2-260C-1 YEAR	-40 to 85	D50	<a href="#">Samples</a>
OPA2350EA/2K5	ACTIVE	VSSOP	DGK	8	2500	RoHS & Green	NIPDAUAG	Level-2-260C-1 YEAR	-40 to 85	D50	<a href="#">Samples</a>
OPA2350EA/2K5G4	ACTIVE	VSSOP	DGK	8	2500	RoHS & Green	NIPDAUAG	Level-2-260C-1 YEAR	-40 to 85	D50	<a href="#">Samples</a>
OPA2350UA	ACTIVE	SOIC	D	8	75	RoHS & Green	NIPDAU	Level-2-260C-1 YEAR	-40 to 85	OPA 2350UA	<a href="#">Samples</a>
OPA2350UA/2K5	ACTIVE	SOIC	D	8	2500	RoHS & Green	NIPDAU	Level-2-260C-1 YEAR	-40 to 85	OPA 2350UA	<a href="#">Samples</a>
OPA2350UA/2K5G4	ACTIVE	SOIC	D	8	2500	RoHS & Green	NIPDAU	Level-2-260C-1 YEAR	-40 to 85	OPA 2350UA	<a href="#">Samples</a>
OPA2350UAG4	ACTIVE	SOIC	D	8	75	RoHS & Green	NIPDAU	Level-2-260C-1 YEAR	-40 to 85	OPA 2350UA	<a href="#">Samples</a>
OPA350EA/250	ACTIVE	VSSOP	DGK	8	250	RoHS & Green	Call TI   NIPDAUAG   NIPDAU	Level-2-260C-1 YEAR	-40 to 85	C50	<a href="#">Samples</a>
OPA350EA/250G4	ACTIVE	VSSOP	DGK	8	250	RoHS & Green	NIPDAU	Level-2-260C-1 YEAR	-40 to 85	C50	<a href="#">Samples</a>
OPA350EA/2K5	ACTIVE	VSSOP	DGK	8	2500	RoHS & Green	Call TI   NIPDAUAG   NIPDAU	Level-2-260C-1 YEAR	-40 to 85	C50	<a href="#">Samples</a>
OPA350UA	ACTIVE	SOIC	D	8	75	RoHS & Green	NIPDAU	Level-2-260C-1 YEAR	-40 to 85	OPA 350UA	<a href="#">Samples</a>
OPA350UA/2K5	ACTIVE	SOIC	D	8	2500	RoHS & Green	NIPDAU	Level-2-260C-1 YEAR	-40 to 85	OPA 350UA	<a href="#">Samples</a>
OPA350UA/2K5G4	ACTIVE	SOIC	D	8	2500	RoHS & Green	NIPDAU	Level-2-260C-1 YEAR	-40 to 85	OPA 350UA	<a href="#">Samples</a>
OPA350UAG4	ACTIVE	SOIC	D	8	75	RoHS & Green	NIPDAU	Level-2-260C-1 YEAR	-40 to 85	OPA 350UA	<a href="#">Samples</a>
OPA4350EA/250	ACTIVE	SSOP	DBQ	16	250	RoHS & Green	NIPDAU	Level-2-260C-1 YEAR		OPA 4350EA	<a href="#">Samples</a>
OPA4350EA/2K5	ACTIVE	SSOP	DBQ	16	2500	RoHS & Green	NIPDAU	Level-2-260C-1 YEAR	-40 to 85	OPA 4350EA	<a href="#">Samples</a>

Orderable Device	Status (1)	Package Type	Package Drawing	Pins	Package Qty	Eco Plan (2)	Lead finish/ Ball material (6)	MSL Peak Temp (3)	Op Temp (°C)	Device Marking (4/5)	Samples
OPA4350UA	ACTIVE	SOIC	D	14	50	RoHS & Green	NIPDAU	Level-2-260C-1 YEAR		OPA4350UA	<a href="#">Samples</a>
OPA4350UA/2K5	ACTIVE	SOIC	D	14	2500	RoHS & Green	NIPDAU	Level-2-260C-1 YEAR		OPA4350UA	<a href="#">Samples</a>
OPA4350UA/2K5G4	ACTIVE	SOIC	D	14	2500	RoHS & Green	NIPDAU	Level-2-260C-1 YEAR		OPA4350UA	<a href="#">Samples</a>

(1) The marketing status values are defined as follows:

**ACTIVE:** Product device recommended for new designs.

**LIFEBUY:** TI has announced that the device will be discontinued, and a lifetime-buy period is in effect.

**NRND:** Not recommended for new designs. Device is in production to support existing customers, but TI does not recommend using this part in a new design.

**PREVIEW:** Device has been announced but is not in production. Samples may or may not be available.

**OBSELETE:** TI has discontinued the production of the device.

(2) **RoHS:** TI defines "RoHS" to mean semiconductor products that are compliant with the current EU RoHS requirements for all 10 RoHS substances, including the requirement that RoHS substance do not exceed 0.1% by weight in homogeneous materials. Where designed to be soldered at high temperatures, "RoHS" products are suitable for use in specified lead-free processes. TI may reference these types of products as "Pb-Free".

**RoHS Exempt:** TI defines "RoHS Exempt" to mean products that contain lead but are compliant with EU RoHS pursuant to a specific EU RoHS exemption.

**Green:** TI defines "Green" to mean the content of Chlorine (Cl) and Bromine (Br) based flame retardants meet JS709B low halogen requirements of <=1000ppm threshold. Antimony trioxide based flame retardants must also meet the <=1000ppm threshold requirement.

(3) MSL, Peak Temp. - The Moisture Sensitivity Level rating according to the JEDEC industry standard classifications, and peak solder temperature.

(4) There may be additional marking, which relates to the logo, the lot trace code information, or the environmental category on the device.

(5) Multiple Device Markings will be inside parentheses. Only one Device Marking contained in parentheses and separated by a "-" will appear on a device. If a line is indented then it is a continuation of the previous line and the two combined represent the entire Device Marking for that device.

(6) Lead finish/Ball material - Orderable Devices may have multiple material finish options. Finish options are separated by a vertical ruled line. Lead finish/Ball material values may wrap to two lines if the finish value exceeds the maximum column width.

**Important Information and Disclaimer:**The information provided on this page represents TI's knowledge and belief as of the date that it is provided. TI bases its knowledge and belief on information provided by third parties, and makes no representation or warranty as to the accuracy of such information. Efforts are underway to better integrate information from third parties. TI has taken and continues to take reasonable steps to provide representative and accurate information but may not have conducted destructive testing or chemical analysis on incoming materials and chemicals. TI and TI suppliers consider certain information to be proprietary, and thus CAS numbers and other limited information may not be available for release.

In no event shall TI's liability arising out of such information exceed the total purchase price of the TI part(s) at issue in this document sold by TI to Customer on an annual basis.

**TAPE AND REEL INFORMATION**

**QUADRANT ASSIGNMENTS FOR PIN 1 ORIENTATION IN TAPE**

\*All dimensions are nominal

Device	Package Type	Package Drawing	Pins	SPQ	Reel Diameter (mm)	Reel Width W1 (mm)	A0 (mm)	B0 (mm)	K0 (mm)	P1 (mm)	W (mm)	Pin1 Quadrant
OPA2350EA/250	VSSOP	DGK	8	250	180.0	12.4	5.3	3.4	1.4	8.0	12.0	Q1
OPA2350EA/2K5	VSSOP	DGK	8	2500	330.0	12.4	5.3	3.4	1.4	8.0	12.0	Q1
OPA2350UA/2K5	SOIC	D	8	2500	330.0	12.4	6.4	5.2	2.1	8.0	12.0	Q1
OPA350EA/250	VSSOP	DGK	8	250	330.0	12.4	5.3	3.4	1.4	8.0	12.0	Q1
OPA350EA/2K5	VSSOP	DGK	8	2500	330.0	12.4	5.3	3.4	1.4	8.0	12.0	Q1
OPA350UA/2K5	SOIC	D	8	2500	330.0	12.4	6.4	5.2	2.1	8.0	12.0	Q1
OPA4350EA/250	SSOP	DBQ	16	250	180.0	12.4	6.4	5.2	2.1	8.0	12.0	Q1
OPA4350EA/2K5	SSOP	DBQ	16	2500	330.0	12.4	6.4	5.2	2.1	8.0	12.0	Q1
OPA4350UA/2K5	SOIC	D	14	2500	330.0	16.4	6.5	9.0	2.1	8.0	16.0	Q1

**TAPE AND REEL BOX DIMENSIONS**

\*All dimensions are nominal

Device	Package Type	Package Drawing	Pins	SPQ	Length (mm)	Width (mm)	Height (mm)
OPA2350EA/250	VSSOP	DGK	8	250	210.0	185.0	35.0
OPA2350EA/2K5	VSSOP	DGK	8	2500	356.0	356.0	35.0
OPA2350UA/2K5	SOIC	D	8	2500	356.0	356.0	35.0
OPA350EA/250	VSSOP	DGK	8	250	353.0	353.0	32.0
OPA350EA/2K5	VSSOP	DGK	8	2500	353.0	353.0	32.0
OPA350UA/2K5	SOIC	D	8	2500	356.0	356.0	35.0
OPA4350EA/250	SSOP	DBQ	16	250	210.0	185.0	35.0
OPA4350EA/2K5	SSOP	DBQ	16	2500	356.0	356.0	35.0
OPA4350UA/2K5	SOIC	D	14	2500	356.0	356.0	35.0

**TUBE**

\*All dimensions are nominal

Device	Package Name	Package Type	Pins	SPQ	L (mm)	W (mm)	T (μm)	B (mm)
OPA2350UA	D	SOIC	8	75	506.6	8	3940	4.32
OPA2350UAG4	D	SOIC	8	75	506.6	8	3940	4.32
OPA350UA	D	SOIC	8	75	506.6	8	3940	4.32
OPA350UAG4	D	SOIC	8	75	506.6	8	3940	4.32
OPA4350UA	D	SOIC	14	50	506.6	8	3940	4.32

# DGK0008A



# PACKAGE OUTLINE

VSSOP - 1.1 mm max height

SMALL OUTLINE PACKAGE



4214862/A 04/2023

**NOTES:**

PowerPAD is a trademark of Texas Instruments.

1. All linear dimensions are in millimeters. Any dimensions in parenthesis are for reference only. Dimensioning and tolerancing per ASME Y14.5M.
2. This drawing is subject to change without notice.
3. This dimension does not include mold flash, protrusions, or gate burrs. Mold flash, protrusions, or gate burrs shall not exceed 0.15 mm per side.
4. This dimension does not include interlead flash. Interlead flash shall not exceed 0.25 mm per side.
5. Reference JEDEC registration MO-187.

# EXAMPLE BOARD LAYOUT

DGK0008A

<sup>TM</sup> VSSOP - 1.1 mm max height

SMALL OUTLINE PACKAGE



LAND PATTERN EXAMPLE  
EXPOSED METAL SHOWN  
SCALE: 15X



4214862/A 04/2023

NOTES: (continued)

6. Publication IPC-7351 may have alternate designs.
7. Solder mask tolerances between and around signal pads can vary based on board fabrication site.
8. Vias are optional depending on application, refer to device data sheet. If any vias are implemented, refer to their locations shown on this view. It is recommended that vias under paste be filled, plugged or tented.
9. Size of metal pad may vary due to creepage requirement.

# EXAMPLE STENCIL DESIGN

DGK0008A

<sup>TM</sup> VSSOP - 1.1 mm max height

SMALL OUTLINE PACKAGE

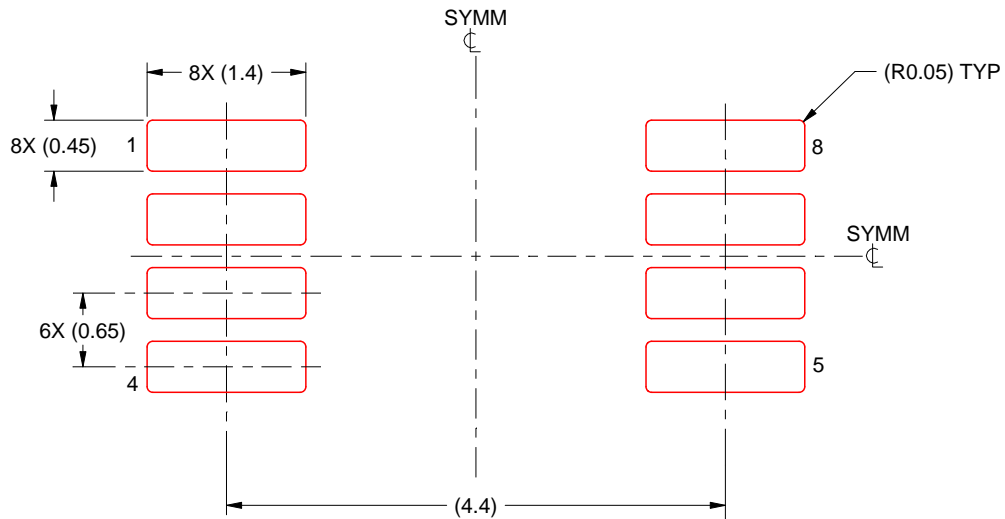

SOLDER PASTE EXAMPLE  
SCALE: 15X

4214862/A 04/2023

NOTES: (continued)



11. Laser cutting apertures with trapezoidal walls and rounded corners may offer better paste release. IPC-7525 may have alternate design recommendations.
12. Board assembly site may have different recommendations for stencil design.

D (R-PDSO-G14)

PLASTIC SMALL OUTLINE



4040047-5/M 06/11

- NOTES:
- A. All linear dimensions are in inches (millimeters).
  - B. This drawing is subject to change without notice.
  -  Body length does not include mold flash, protrusions, or gate burrs. Mold flash, protrusions, or gate burrs shall not exceed 0.006 (0,15) each side.
  -  Body width does not include interlead flash. Interlead flash shall not exceed 0.017 (0,43) each side.
  - E. Reference JEDEC MS-012 variation AB.

D (R-PDSO-G14)

PLASTIC SMALL OUTLINE



4211283-3/E 08/12

- NOTES:
- A. All linear dimensions are in millimeters.
  - B. This drawing is subject to change without notice.
  - C. Publication IPC-7351 is recommended for alternate designs.
  - D. Laser cutting apertures with trapezoidal walls and also rounding corners will offer better paste release. Customers should contact their board assembly site for stencil design recommendations. Refer to IPC-7525 for other stencil recommendations.
  - E. Customers should contact their board fabrication site for solder mask tolerances between and around signal pads.



D0008A

# PACKAGE OUTLINE

SOIC - 1.75 mm max height

SMALL OUTLINE INTEGRATED CIRCUIT



4214825/C 02/2019

### NOTES:

1. Linear dimensions are in inches [millimeters]. Dimensions in parenthesis are for reference only. Controlling dimensions are in inches. Dimensioning and tolerancing per ASME Y14.5M.
2. This drawing is subject to change without notice.
3. This dimension does not include mold flash, protrusions, or gate burrs. Mold flash, protrusions, or gate burrs shall not exceed  $.006$  [0.15] per side.
4. This dimension does not include interlead flash.
5. Reference JEDEC registration MS-012, variation AA.

# EXAMPLE BOARD LAYOUT

D0008A

SOIC - 1.75 mm max height

SMALL OUTLINE INTEGRATED CIRCUIT



LAND PATTERN EXAMPLE  
 EXPOSED METAL SHOWN  
 SCALE:8X



SOLDER MASK DETAILS

4214825/C 02/2019

NOTES: (continued)

- 6. Publication IPC-7351 may have alternate designs.
- 7. Solder mask tolerances between and around signal pads can vary based on board fabrication site.

# EXAMPLE STENCIL DESIGN

D0008A

SOIC - 1.75 mm max height

SMALL OUTLINE INTEGRATED CIRCUIT



SOLDER PASTE EXAMPLE  
BASED ON .005 INCH [0.125 MM] THICK STENCIL  
SCALE:8X

4214825/C 02/2019

NOTES: (continued)

8. Laser cutting apertures with trapezoidal walls and rounded corners may offer better paste release. IPC-7525 may have alternate design recommendations.
9. Board assembly site may have different recommendations for stencil design.



# EXAMPLE BOARD LAYOUT

DBQ0016A

SSOP - 1.75 mm max height

SHRINK SMALL-OUTLINE PACKAGE

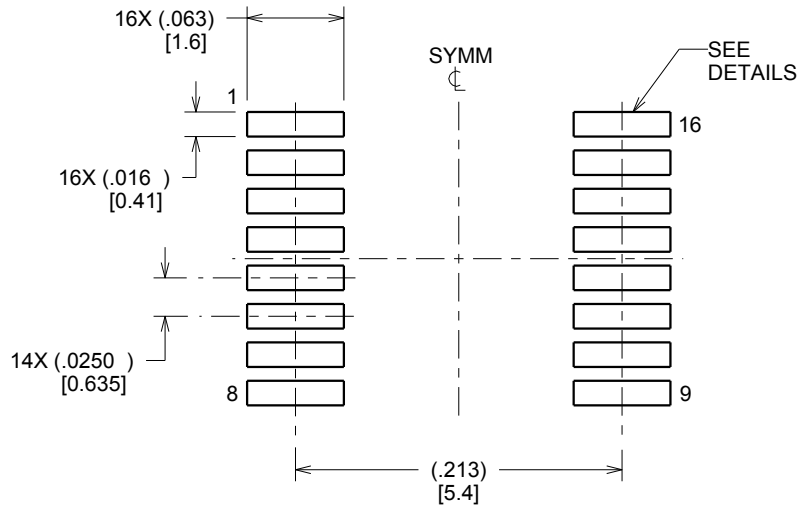

LAND PATTERN EXAMPLE  
SCALE:8X

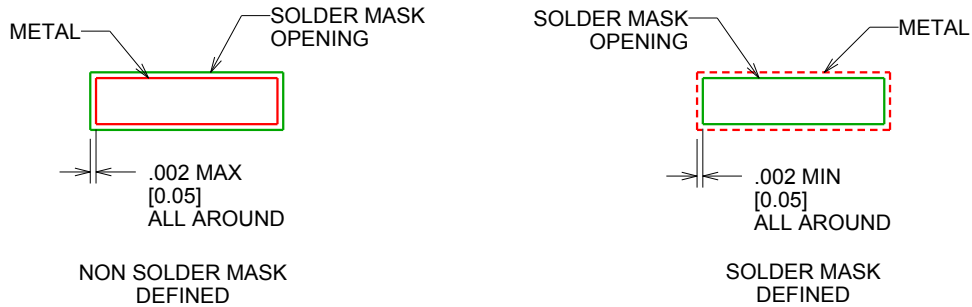

SOLDER MASK DETAILS

4214846/A 03/2014

NOTES: (continued)

6. Publication IPC-7351 may have alternate designs.
7. Solder mask tolerances between and around signal pads can vary based on board fabrication site.

# EXAMPLE STENCIL DESIGN

DBQ0016A

SSOP - 1.75 mm max height

SHRINK SMALL-OUTLINE PACKAGE

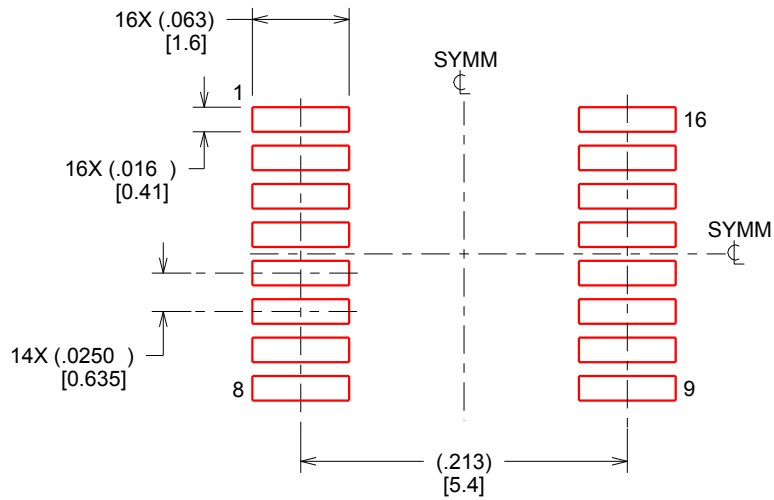

SOLDER PASTE EXAMPLE  
BASED ON .005 INCH [0.127 MM] THICK STENCIL  
SCALE:8X

4214846/A 03/2014

NOTES: (continued)

8. Laser cutting apertures with trapezoidal walls and rounded corners may offer better paste release. IPC-7525 may have alternate design recommendations.
9. Board assembly site may have different recommendations for stencil design.

## IMPORTANT NOTICE AND DISCLAIMER

TI PROVIDES TECHNICAL AND RELIABILITY DATA (INCLUDING DATA SHEETS), DESIGN RESOURCES (INCLUDING REFERENCE DESIGNS), APPLICATION OR OTHER DESIGN ADVICE, WEB TOOLS, SAFETY INFORMATION, AND OTHER RESOURCES "AS IS" AND WITH ALL FAULTS, AND DISCLAIMS ALL WARRANTIES, EXPRESS AND IMPLIED, INCLUDING WITHOUT LIMITATION ANY IMPLIED WARRANTIES OF MERCHANTABILITY, FITNESS FOR A PARTICULAR PURPOSE OR NON-INFRINGEMENT OF THIRD PARTY INTELLECTUAL PROPERTY RIGHTS.

These resources are intended for skilled developers designing with TI products. You are solely responsible for (1) selecting the appropriate TI products for your application, (2) designing, validating and testing your application, and (3) ensuring your application meets applicable standards, and any other safety, security, regulatory or other requirements.

These resources are subject to change without notice. TI grants you permission to use these resources only for development of an application that uses the TI products described in the resource. Other reproduction and display of these resources is prohibited. No license is granted to any other TI intellectual property right or to any third party intellectual property right. TI disclaims responsibility for, and you will fully indemnify TI and its representatives against, any claims, damages, costs, losses, and liabilities arising out of your use of these resources.

TI's products are provided subject to [TI's Terms of Sale](#) or other applicable terms available either on [ti.com](https://www.ti.com) or provided in conjunction with such TI products. TI's provision of these resources does not expand or otherwise alter TI's applicable warranties or warranty disclaimers for TI products.

TI objects to and rejects any additional or different terms you may have proposed.

Mailing Address: Texas Instruments, Post Office Box 655303, Dallas, Texas 75265  
Copyright © 2024, Texas Instruments Incorporated

## Looking for pricing, stock, or lifecycle information?

Click below to explore more details on WIN SOURCE:

 [View OPA350UA/2K5 on WIN SOURCE](#)

 [Texas Instruments](#) Information

## Optimize Your Supply Chain with WIN SOURCE Solutions

-  Global Sourcing Solution
-  Obsolete Management
-  Cost Control Management
-  Shortage Management
-  Alternative Solution
-  Excess Inventory Management