



**THE DATASHEET OF  
OPA4234U/2K5G4**





# Low-Power, Precision SINGLE-SUPPLY OPERATIONAL AMPLIFIERS

## FEATURES

- **WIDE SUPPLY RANGE:**  
Single Supply:  $V_S = +2.7V$  to  $+36V$   
Dual Supply:  $V_S = \pm 1.35V$  to  $\pm 18V$
- **SPECIFIED PERFORMANCE:**  
 $+2.7V$ ,  $+5V$ , and  $\pm 15V$
- **LOW QUIESCENT CURRENT:**  $250\mu A/amp$
- **LOW INPUT BIAS CURRENT:**  $25nA$  max
- **LOW OFFSET VOLTAGE:**  $100\mu V$  max
- **HIGH CMRR, PSRR, and  $A_{OL}$**
- **SINGLE, DUAL, and QUAD VERSIONS**

## DESCRIPTION

The OPA234 series low-cost op amps are ideal for single-supply, low-voltage, low-power applications. The series provides lower quiescent current than older "1013"-type products and comes in current industry-standard packages and pinouts. The combination of low offset voltage, high common-mode rejection, high power-supply rejection, and a wide supply range provides excellent accuracy and versatility. Single, dual, and quad versions have identical specifications for maximum design flexibility. These general-purpose op amps are ideal for portable and battery-powered applications.

The OPA234 series op amps operate from either single or dual supplies. In single-supply operation, the input common-mode range extends below ground and the output can swing to within 50mV of ground. Excellent phase margin makes the OPA234 series ideal for demanding applications, including high load capacitance. Dual and quad designs feature completely independent circuitry for lowest crosstalk and freedom from interaction.

Single version packages are in an SO-8 surface-mount and a space-saving MSOP-8 surface-mount. Dual packages are in an SO-8 surface-mount. Quad packages are in an SO-14 surface-mount. All are specified for  $-40^\circ C$  to  $+85^\circ C$  operation.

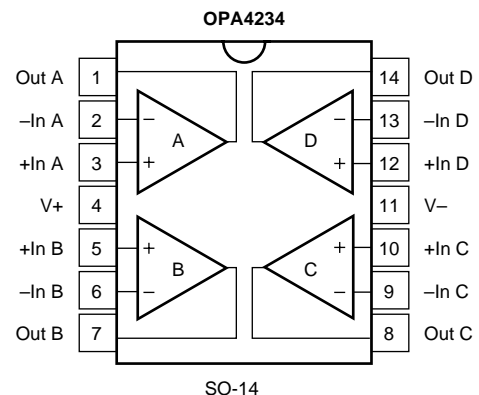
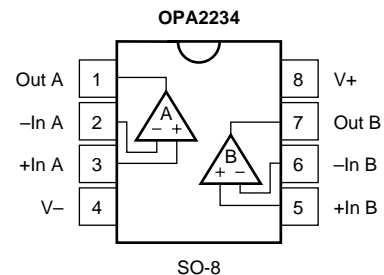
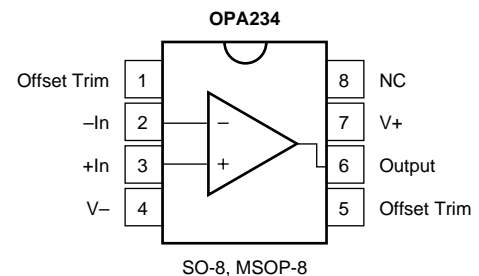

Please be aware that an important notice concerning availability, standard warranty, and use in critical applications of Texas Instruments semiconductor products and disclaimers thereto appears at the end of this data sheet.

All trademarks are the property of their respective owners.

# ELECTRICAL CHARACTERISTICS: $V_S = +5V$

At  $T_A = 25^\circ C$ ,  $V_S = +5V$ ,  $R_L = 10k\Omega$  connected to  $V_S/2$ , and  $V_{OUT} = V_S/2$ , unless otherwise noted.

| PARAMETER   | CONDITION                            | OPA234U, E<br>OPA2234U   |                                   |  | OPA234UA, EA<br>OPA2234UA<br>OPA4234UA, U |          |     | UNITS                       |  |
|---|--------------------------------------|--|-----------------------------------|--|---|----------|-----|-----------------------------|--|
|   |                                      | MIN  | TYP                               | MAX  | MIN                                       | TYP      | MAX |                             |  |
| <b>OFFSET VOLTAGE</b><br>Input Offset Voltage<br>OPA234E, EA<br>vs Temperature <sup>(1)</sup><br>vs Power Supply<br>vs Time<br>Channel Separation (Dual, Quad)                                  | $V_{OS}$<br><br>$dV_{OS}/dT$<br>PSRR | $V_{CM} = 2.5V$<br><br>Operating Temperature Range<br>$V_S = +2.7V$ to $+30V$ , $V_{CM} = 1.7V$  |                                   | $\pm 40$<br>$\pm 100$<br>$\pm 0.5$<br>3<br>0.2<br>0.3        | $\pm 100$<br>$\pm 150$<br>$\pm 3$<br>10   |          | *   | $\pm 250$<br>$\pm 350$<br>* | $\mu V$<br>$\mu V$<br>$\mu V/^\circ C$<br>$\mu V/V$<br>$\mu V/mo$<br>$\mu V/V$   |
| <b>INPUT BIAS CURRENT</b><br>Input Bias Current <sup>(2)</sup><br>Input Offset Current  | $I_B$<br>$I_{OS}$                    | $V_{CM} = 2.5V$<br>$V_{CM} = 2.5V$   |                                   | -15<br>$\pm 1$   | -30<br>$\pm 5$                            |          | *   | -50<br>*                    | nA<br>nA   |
| <b>NOISE</b><br>Input Voltage Noise Density<br>Current Noise Density  | $v_n$<br>$i_n$                       | $f = 1kHz$   |                                   | 25<br>80   |   |          | *   | *                           | $nV/\sqrt{Hz}$<br>$fA/\sqrt{Hz}$   |
| <b>INPUT VOLTAGE RANGE</b><br>Common-Mode Voltage Range<br>Common-Mode Rejection  | CMRR                                 | $V_{CM} = -0.1V$ to $4V$   | -0.1<br>91                        | 106  | (V+) -1                                   | *        | *   | *                           | V<br>dB  |
| <b>INPUT IMPEDANCE</b><br>Differential<br>Common-Mode   |                                      | $V_{CM} = 2.5V$  |                                   | $10^7 \parallel 5$<br>$10^{10} \parallel 6$                  |   | *        | *   |                             | $\Omega \parallel pF$<br>$\Omega \parallel pF$   |
| <b>OPEN-LOOP GAIN</b><br>Open-Loop Voltage Gain   | $A_{OL}$                             | $V_O = 0.25V$ to $4V$<br>$R_L = 10k\Omega$<br>$R_L = 2k\Omega$   | 108<br>86                         | 120<br>96  |   | 100<br>* | *   | *                           | dB<br>dB   |
| <b>FREQUENCY RESPONSE</b><br>Gain-Bandwidth Product<br>Slew Rate<br>Settling Time: 0.1%<br>0.01%<br>Overload Recovery Time  | GBW<br>SR                            | $C_L = 100pF$<br><br>$G = 1$ , 3V Step, $C_L = 100pF$<br>$G = 1$ , 3V Step, $C_L = 100pF$<br>( $V_{IN}$ ) (Gain) = $V_S$                   |                                   | 0.35<br>0.2<br>15<br>25<br>16                                |   |          | *   | *                           | MHz<br>V/ $\mu s$<br>$\mu s$<br>$\mu s$<br>$\mu s$   |
| <b>OUTPUT</b><br>Voltage Output: Positive<br>Negative<br>Positive<br>Negative<br>Short-Circuit Current<br>Capacitive Load Drive (Stable Operation) <sup>(3)</sup>                               | $I_{SC}$                             | $R_L = 10k\Omega$ to $V_S/2$<br>$R_L = 10k\Omega$ to $V_S/2$<br>$R_L = 10k\Omega$ to Ground<br>$R_L = 10k\Omega$ to Ground<br><br>$G = +1$ | (V+) -1<br>0.25<br>(V+) -1<br>0.1 | (V+) -0.65<br>0.05<br>(V+) -0.65<br>0.05<br>$\pm 11$<br>1000 |   | *        | *   | *                           | V<br>V<br>V<br>V<br>mA<br>pF   |
| <b>POWER SUPPLY</b><br>Specified Operating Voltage<br>Operating Voltage Range<br>Quiescent Current (per amplifier)  | $I_Q$                                | $I_O = 0$  | +2.7                              | +5<br>250  | +36<br>300                                | *        | *   | *                           | V<br>V<br>$\mu A$  |
| <b>TEMPERATURE RANGE</b><br>Specified Range<br>Operating Range<br>Storage<br>Thermal Resistance<br>8-Pin DIP<br>SO-8 Surface-Mount<br>MSOP-8 Surface-Mount<br>14-Pin DIP<br>SO-14 Surface-Mount | $\theta_{JA}$                        |  | -40<br>-40<br>-55                 |  | +85<br>+125<br>+125                       | *        | *   | *                           | $^\circ C$<br>$^\circ C$<br>$^\circ C$<br>$^\circ C/W$<br>$^\circ C/W$<br>$^\circ C/W$<br>$^\circ C/W$<br>$^\circ C/W$ |

\* Specifications same as OPA234U, E.

NOTES: (1) Wafer-level tested to 95% confidence level. (2) Positive conventional current flows into the input terminals. (3) See *Small-Signal Overshoot vs Load Capacitance* typical curve.

# ELECTRICAL CHARACTERISTICS: $V_S = +2.7V$

At  $T_A = 25^\circ C$ ,  $V_S = +2.7V$ ,  $R_L = 10k\Omega$  connected to  $V_S/2$ , and  $V_{OUT} = V_S/2$ , unless otherwise noted.

| PARAMETER   | CONDITION     | OPA234U, E<br>OPA2234U   |            |                       | OPA234UA, EA<br>OPA2234UA<br>OPA4234UA, U |           |           | UNITS                 |
|---|---------------|--|------------|-----------------------|---|-----------|-----------|-----------------------|
|   |               | MIN  | TYP        | MAX                   | MIN                                       | TYP       | MAX       |                       |
| <b>OFFSET VOLTAGE</b>                                   |               |  |            |                       |   |           |           |                       |
| Input Offset Voltage<br>OPA234E, EA                     | $V_{OS}$      |  | $\pm 40$   | $\pm 100$             |   | *         | $\pm 250$ | $\mu V$               |
| vs Temperature <sup>(1)</sup>                           | $dV_{OS}/dT$  |  | $\pm 100$  | $\pm 150$             |   | *         | $\pm 350$ | $\mu V$               |
| vs Power Supply   | PSRR          |  | $\pm 0.5$  | $\pm 3$               |   | *         | *         | $\mu V/^\circ C$      |
| vs Time   |               |  | 3          | 10                    |   | *         | 20        | $\mu V/V$             |
| Channel Separation (Dual, Quad)                         |               |  | 0.2        |                       |   | *         |           | $\mu V/mo$            |
|   |               |  | 0.3        |                       |   | *         |           | $\mu V/V$             |
| <b>INPUT BIAS CURRENT</b>                               |               |  |            |                       |   |           |           |                       |
| Input Bias Current <sup>(2)</sup>                       | $I_B$         | $V_{CM} = 1.35V$   | -15        | -30                   |   | *         | -50       | nA                    |
| Input Offset Current                                    | $I_{OS}$      | $V_{CM} = 1.35V$   | $\pm 1$    | $\pm 5$               |   | *         | *         | n                     |
| <b>NOISE</b>  |               | $f = 1kHz$   |            |                       |   |           |           |                       |
| Input Voltage Noise Density                             | $V_n$         |  | 25         |                       |   | *         |           | $nV/\sqrt{Hz}$        |
| Current Noise Density                                   | $i_n$         |  | 80         |                       |   | *         |           | $fA/\sqrt{Hz}$        |
| <b>INPUT VOLTAGE RANGE</b>                              |               |  |            |                       |   |           |           |                       |
| Common-Mode Voltage Range                               |               |  | -0.1       |                       | $(V+) - 1$                                | *         | *         | V                     |
| Common-Mode Rejection                                   | CMRR          | $V_{CM} = -0.1V$ to $1.7V$                                       | 91         | 106                   |   | 86        | *         | dB                    |
| <b>INPUT IMPEDANCE</b>                                  |               |  |            |                       |   |           |           |                       |
| Differential  |               | $V_{CM} = 1.35V$   |            | $10^7 \parallel 5$    |   | *         |           | $\Omega \parallel pF$ |
| Common-Mode   |               |  |            | $10^{10} \parallel 6$ |   | *         |           | $\Omega \parallel pF$ |
| <b>OPEN-LOOP GAIN</b>                                   |               |  |            |                       |   |           |           |                       |
| Open-Loop Voltage Gain                                  | $A_{OL}$      | $V_O = 0.25V$ to $1.7V$<br>$R_L = 10k\Omega$<br>$R_L = 2k\Omega$ | 108<br>86  | 125<br>96             |   | 100<br>86 | *<br>*    | dB<br>dB              |
| <b>FREQUENCY RESPONSE</b>                               |               |  |            |                       |   |           |           |                       |
| Gain-Bandwidth Product                                  | GBW           | $C_L = 100pF$  |            | 0.35                  |   | *         |           | MHz                   |
| Slew Rate   | SR            |  |            | 0.2                   |   | *         |           | $V/\mu s$             |
| Settling Time: 0.1%                                     |               | $G = 1$ , 1V Step, $C_L = 100pF$                                 |            | 6                     |   | *         |           | $\mu s$               |
| 0.01%   |               | $G = 1$ , 1V Step, $C_L = 100pF$                                 |            | 16                    |   | *         |           | $\mu s$               |
| Overload Recovery Time                                  |               | $(V_{IN})$ (Gain) = $V_S$  |            | 8                     |   | *         |           | $\mu s$               |
| <b>OUTPUT</b>   |               |  |            |                       |   |           |           |                       |
| Voltage Output: Positive                                |               | $R_L = 10k\Omega$ to $V_S/2$                                     | $(V+) - 1$ | $(V+) - 0.6$          |   | *         | *         | V                     |
| Negative  |               | $R_L = 10k\Omega$ to $V_S/2$                                     | 0.25       | 0.05                  |   | *         | *         | V                     |
| Positive  |               | $R_L = 10k\Omega$ to Ground                                      | $(V+) - 1$ | $(V+) - 0.65$         |   | *         | *         | V                     |
| Negative  |               | $R_L = 10k\Omega$ to Ground                                      | 0.1        | 0.05                  |   | *         | *         | V                     |
| Short-Circuit Current                                   | $I_{SC}$      |  |            | $\pm 8$               |   | *         | *         | mA                    |
| Capacitive Load Drive (Stable Operation) <sup>(3)</sup> |               | $G = +1$   |            | 1000                  |   | *         | *         | pF                    |
| <b>POWER SUPPLY</b>                                     |               |  |            |                       |   |           |           |                       |
| Specified Operating Voltage                             |               |  | +2.7       | +2.7                  |   | *         | *         | V                     |
| Operating Voltage Range                                 |               |  |            |                       |   | *         | *         | V                     |
| Quiescent Current (per amplifier)                       | $I_Q$         | $I_O = 0$  |            | 250                   |   | 300       | *         | $\mu A$               |
| <b>TEMPERATURE RANGE</b>                                |               |  |            |                       |   |           |           |                       |
| Specified Range   |               |  | -40        |                       |   | +85       | *         | $^\circ C$            |
| Operating Range   |               |  | -40        |                       |   | +125      | *         | $^\circ C$            |
| Storage   |               |  | -55        |                       |   | +125      | *         | $^\circ C$            |
| Thermal Resistance                                      | $\theta_{JA}$ |  |            |                       |   |           |           |                       |
| 8-Pin DIP   |               |  |            | 100                   |   |           | *         | $^\circ C/W$          |
| SO-8 Surface-Mount                                      |               |  |            | 150                   |   |           | *         | $^\circ C/W$          |
| MSOP-8 Surface-Mount                                    |               |  |            | 220                   |   |           | *         | $^\circ C/W$          |
| 14-Pin DIP  |               |  |            | 80                    |   |           | *         | $^\circ C/W$          |
| SO-14 Surface-Mount                                     |               |  |            | 110                   |   |           | *         | $^\circ C/W$          |

\* Specifications same as OPA234U, E.

NOTES: (1) Wafer-level tested to 95% confidence level. (2) Positive conventional current flows into the input terminals. (3) See *Small-Signal Overshoot vs Load Capacitance* typical curve.

# ELECTRICAL CHARACTERISTICS: $V_S = \pm 15V$

At  $T_A = 25^\circ C$ ,  $V_S = \pm 15V$ , and  $R_L = 10k\Omega$  connected to ground, unless otherwise noted.

| PARAMETER   | CONDITION                              | OPA234U, E<br>OPA2234U   |                      |   | OPA234UA, EA<br>OPA2234UA<br>OPA4234UA, U |             |                              | UNITS                             |  |
|---|--|--|----------------------|---|---|-------------|------------------------------|-----------------------------------|--|
|   |  | MIN  | TYP                  | MAX   | MIN                                       | TYP         | MAX                          |                                   |  |
| <b>OFFSET VOLTAGE</b><br>Input Offset Voltage<br>OPA4234U Model<br>vs Temperature <sup>(1)</sup><br>vs Power Supply<br>vs Time<br>Channel Separation (Dual, Quad)                               | $V_{OS}$<br><br>$dV_{OS}/dT$<br>$PSRR$ | $V_{CM} = 0V$<br><br>Operating Temperature Range<br>$V_S = \pm 1.35V$ to $\pm 18V$ , $V_{CM} = 0V$                         |                      | $\pm 70$<br>$\pm 0.5$<br>3<br>0.2<br>0.3    | $\pm 250$<br>$\pm 5$<br>10                |             | *<br>$\pm 70$<br>*<br>*<br>* | $\pm 500$<br>$\pm 250$<br>*<br>20 | $\mu V$<br>$\mu V$<br>$\mu V/^\circ C$<br>$\mu V/V$<br>$\mu V/mo$<br>$\mu V/V$   |
| <b>INPUT BIAS CURRENT</b><br>Input Bias Current <sup>(2)</sup><br>Input Offset Current  | $I_B$<br>$I_{OS}$                      | $V_{CM} = 0V$<br>$V_{CM} = 0V$   |                      | -12<br>$\pm 1$                              | -25<br>$\pm 5$                            |             | *<br>*                       | -50<br>*                          | nA<br>nA   |
| <b>NOISE</b><br>Input Voltage Noise Density<br>Current Noise Density  | $V_n$<br>$i_n$                         | $f = 1kHz$   |                      | 25<br>80                                    |   |             | *<br>*                       |                                   | $nV/\sqrt{Hz}$<br>$fA/\sqrt{Hz}$   |
| <b>INPUT VOLTAGE RANGE</b><br>Common-Mode Voltage Range<br>Common-Mode Rejection  | CMRR                                   | $V_{CM} = -15V$ to $14V$   | (V-)<br>91           | 106   | (V+) -1                                   | *<br>86     | *<br>*                       | *<br>*                            | V<br>dB  |
| <b>INPUT IMPEDANCE</b><br>Differential<br>Common-Mode   |  | $V_{CM} = 0V$  |                      | $10^7 \parallel 5$<br>$10^{10} \parallel 6$ |   |             | *<br>*                       |                                   | $\Omega \parallel pF$<br>$\Omega \parallel pF$   |
| <b>OPEN-LOOP GAIN</b><br>Open-Loop Voltage Gain   | $A_{OL}$                               | $V_O = -14.5V$ to $14V$  | 110                  | 120   |   | 100         | *                            |                                   | dB   |
| <b>FREQUENCY RESPONSE</b><br>Gain-Bandwidth Product<br>Slew Rate<br>Settling Time: 0.1%<br>0.01%<br>Overload Recovery Time  | GBW<br>SR                              | $C_L = 100pF$<br><br>$G = 1$ , 10V Step, $C_L = 100pF$<br>$G = 1$ , 10V Step, $C_L = 100pF$<br>( $V_{IN}$ ) (Gain) = $V_S$ |                      | 0.35<br>0.2<br>41<br>47<br>22               |   |             | *<br>*<br>*<br>*<br>*        |                                   | MHz<br>V/ $\mu s$<br>$\mu s$<br>$\mu s$<br>$\mu s$   |
| <b>OUTPUT</b><br>Voltage Output: Positive<br>Negative<br>Short-Circuit Current<br>Capacitive Load Drive (Stable Operation) <sup>(3)</sup>   | $I_{SC}$                               | $G = +1$   | (V+) -1<br>(V-) +0.5 | (V+) -0.7<br>(V-) +0.15<br>$\pm 22$<br>1000 |   | *<br>*      | *<br>*<br>*<br>*             |                                   | V<br>V<br>mA<br>pF   |
| <b>POWER SUPPLY</b><br>Specified Operating Voltage<br>Operating Voltage Range<br>Quiescent Current (per amplifier)  | $I_Q$                                  | $I_O = 0$  | $\pm 1.35$           | $\pm 15$<br>$\pm 275$                       | $\pm 18$<br>$\pm 350$                     | *<br>*      | *<br>*                       | *<br>*                            | V<br>V<br>$\mu A$  |
| <b>TEMPERATURE RANGE</b><br>Specified Range<br>Operating Range<br>Storage<br>Thermal Resistance<br>8-Pin DIP<br>SO-8 Surface-Mount<br>MSOP-8 Surface-Mount<br>14-Pin DIP<br>SO-14 Surface-Mount | $\theta_{JA}$                          |  | -40<br>-40<br>-55    |   | +85<br>+125<br>+125                       | *<br>*<br>* | *<br>*<br>*                  | *<br>*<br>*                       | $^\circ C$<br>$^\circ C$<br>$^\circ C$<br>$^\circ C/W$<br>$^\circ C/W$<br>$^\circ C/W$<br>$^\circ C/W$<br>$^\circ C/W$ |

\* Specifications same as OPA234U, E.

NOTES: (1) Wafer-level tested to 95% confidence level. (2) Positive conventional current flows into the input terminals. (3) See *Small-Signal Overshoot vs Load Capacitance* typical curve.



# ELECTROSTATIC DISCHARGE SENSITIVITY

This integrated circuit can be damaged by ESD. Texas Instruments recommends that all integrated circuits be handled with appropriate precautions. Failure to observe proper handling and installation procedures can cause damage.

ESD damage can range from subtle performance degradation to complete device failure. Precision integrated circuits may be more susceptible to damage because very small parametric changes could cause the device not to meet its published specifications.

## PACKAGE INFORMATION

| PRODUCT   | PACKAGE  | PACKAGE MARKING                 |
|---|--|---------------------------------|
| <b>Single</b><br>OPA234EA<br>OPA234E<br>OPA234UA<br>OPA234U | MSOP-8 Surface-Mount<br>"<br>SO-8 Surface-Mount<br>" | A34<br>"<br>OPA234UA<br>OPA234U |
| <b>Dual</b><br>OPA2234UA<br>OPA2234U                        | SO-8 Surface-Mount<br>"                              | OPA2234UA<br>OPA2234U           |
| <b>Quad</b><br>OPA4234UA<br>OPA4234U                        | SO-8 Surface-Mount<br>"                              | OPA4234UA<br>OPA4234U           |

NOTE: (1) For the most current package and ordering information, see the Package Option Addendum located at the end of this data sheet.

## ABSOLUTE MAXIMUM RATINGS

|   |                          |
|---|--------------------------|
| Supply Voltage, V+ to V- .....            | 36V                      |
| Input Voltage .....                       | (V-) -0.7V to (V+) +0.7V |
| Output Short-Circuit <sup>(1)</sup> ..... | Continuous               |
| Operating Temperature .....               | -40°C to +125°C          |
| Storage Temperature .....                 | -55°C to +125°C          |
| Junction Temperature .....                | 150°C                    |
| Lead Temperature (soldering, 10s) .....   | 300°C                    |

NOTE: (1) Short-circuit to ground, one amplifier per package.

# TYPICAL CHARACTERISTIC CURVES

At  $T_A = +25^\circ\text{C}$  and  $R_L = 10\text{k}\Omega$ , unless otherwise noted.

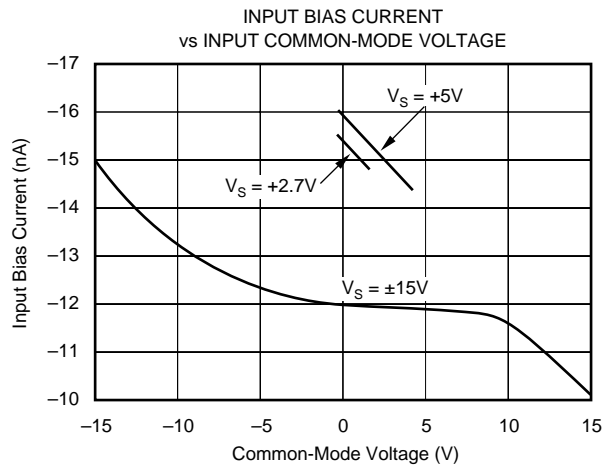
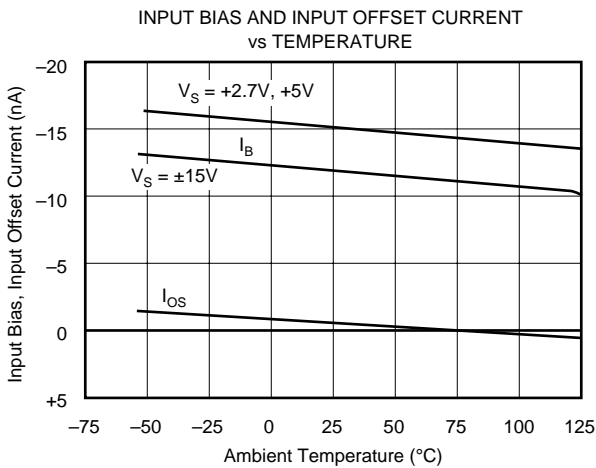
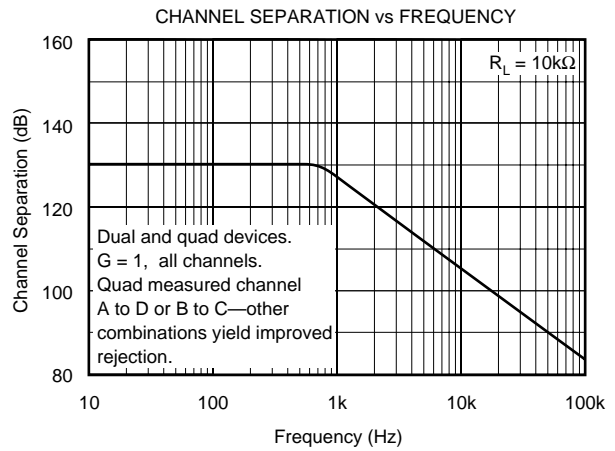
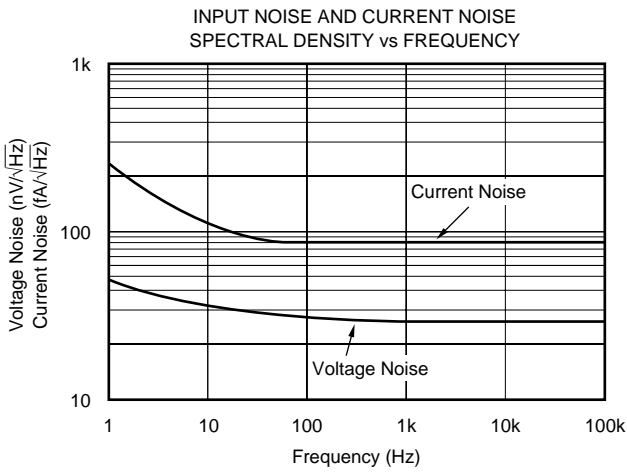
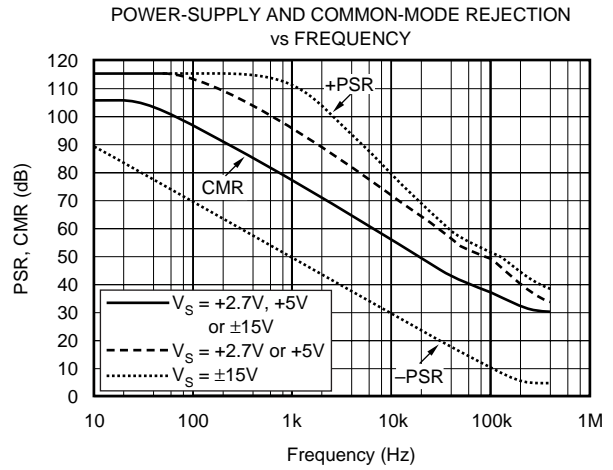
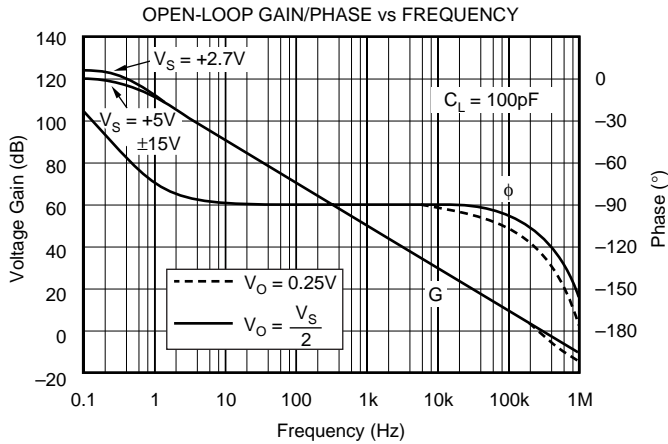

# TYPICAL CHARACTERISTIC CURVES (Cont.)

At  $T_A = +25^\circ\text{C}$  and  $R_L = 10\text{k}\Omega$ , unless otherwise noted.

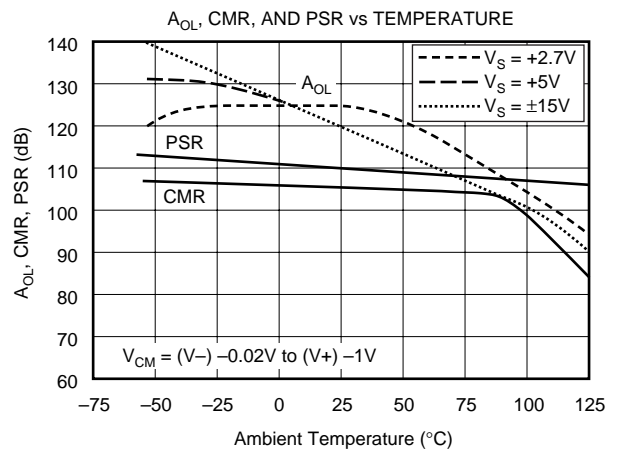
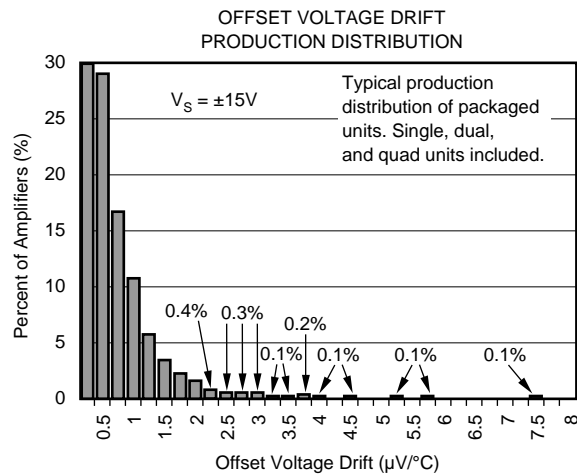
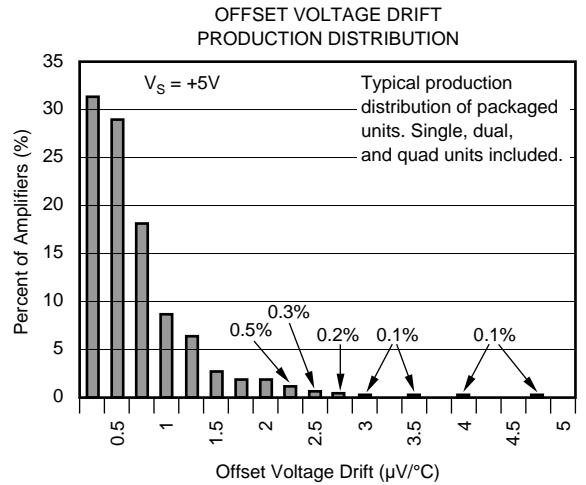
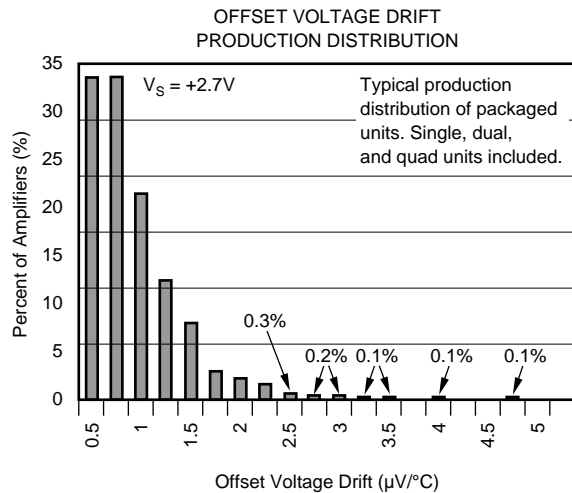
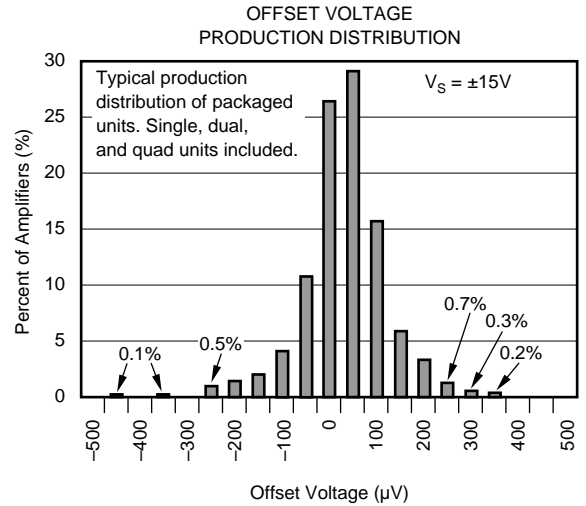
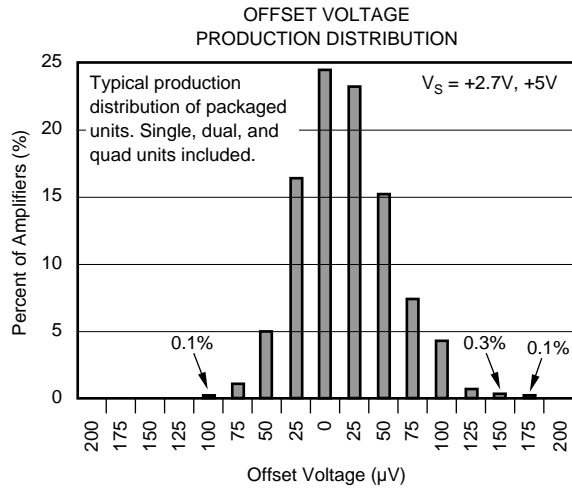

# TYPICAL CHARACTERISTIC CURVES (Cont.)

At  $T_A = +25^\circ\text{C}$  and  $R_L = 10\text{k}\Omega$ , unless otherwise noted.

SMALL-SIGNAL STEP RESPONSE  
 $G = 1$ ,  $C_L = 100\text{pF}$ ,  $V_S = +5\text{V}$

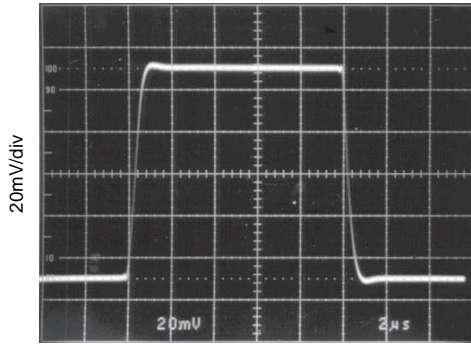

SMALL-SIGNAL STEP RESPONSE  
 $G = 1$ ,  $C_L = 10,000\text{pF}$ ,  $V_S = +5\text{V}$

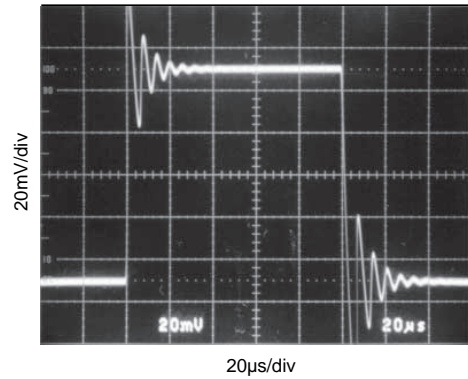

LARGE-SIGNAL STEP RESPONSE  
 $G = 1$ ,  $C_L = 100\text{pF}$ ,  $V_S = +5\text{V}$

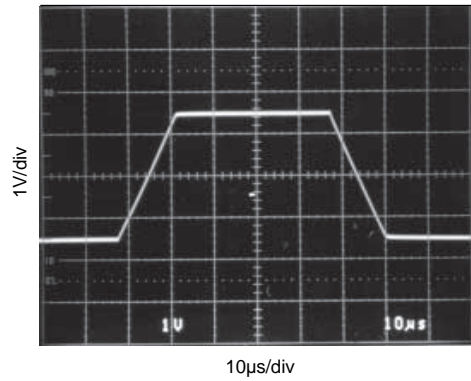

SETTLING TIME vs CLOSED-LOOP GAIN

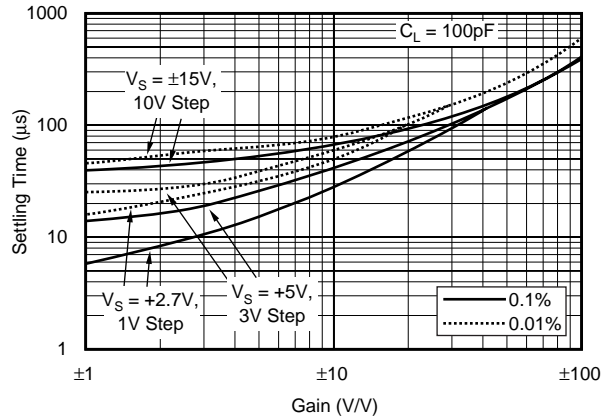

OUTPUT VOLTAGE SWING vs OUTPUT CURRENT

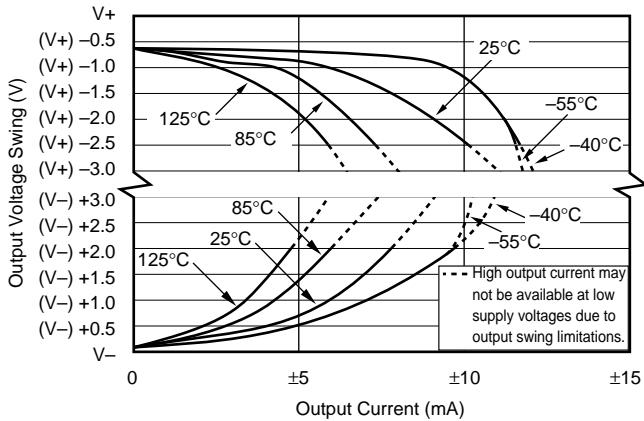

SMALL-SIGNAL OVERSHOOT vs LOAD CAPACITANCE

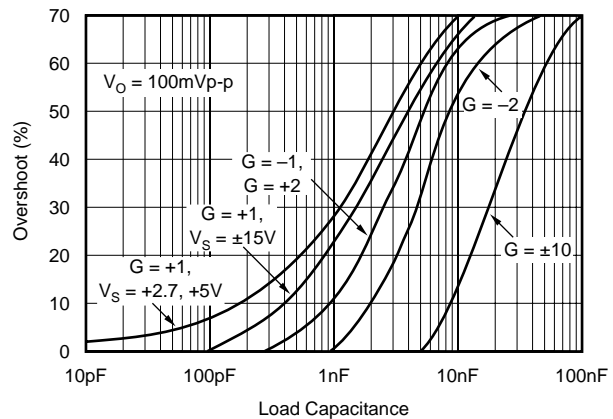

# TYPICAL CHARACTERISTIC CURVES (Cont.)

At  $T_A = +25^\circ\text{C}$  and  $R_L = 10\text{k}\Omega$ , unless otherwise noted.

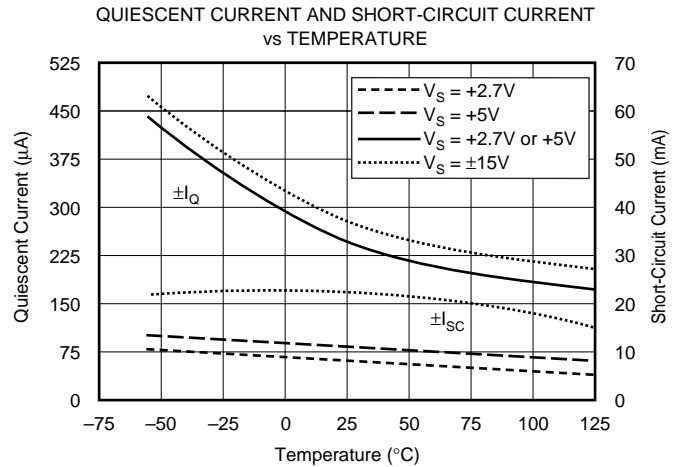
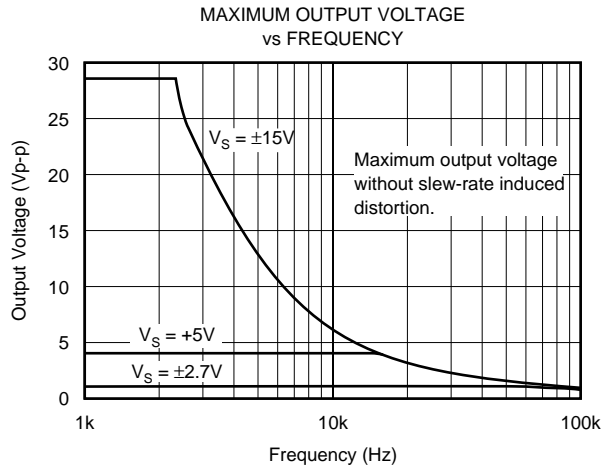

## APPLICATIONS INFORMATION

The OPA234 series op amps are unity-gain stable and suitable for a wide range of general-purpose applications. Power-supply pins should be bypassed with 10nF ceramic capacitors.

### OPERATING VOLTAGE

The OPA234 series op amps operate from single (+2.7V to +36V) or dual ( $\pm 1.35\text{V}$  to  $\pm 18\text{V}$ ) supplies with excellent performance. Specifications are production tested with +2.7V, +5V, and  $\pm 15\text{V}$  supplies. Most behavior remains unchanged throughout the full operating voltage range. Parameters which vary significantly with operating voltage are shown in the Typical Characteristic curves.

### OFFSET VOLTAGE TRIM

Offset voltage of the OPA234 series amplifiers is laser trimmed and usually requires no user adjustment. The OPA234 (single op amp version) provides offset voltage trim connections on pins 1 and 5. Offset voltage can be adjusted by connecting a potentiometer, as shown in Figure 1. This adjustment should be used only to null the offset of the op amp, not to adjust system offset or offset produced by the signal source. Nulling offset could degrade the offset drift behavior of the op amp. While it is not possible to predict the exact change in drift, the effect is usually small.

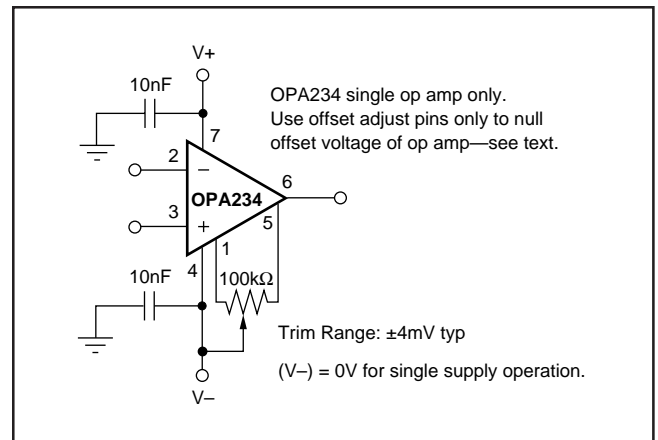

FIGURE 1. OPA234 Offset Voltage Trim Circuit.

**PACKAGING INFORMATION**

| Orderable Device | Status<br>(1) | Package Type | Package Drawing | Pins | Package Qty | Eco Plan<br>(2)         | Lead/Ball Finish<br>(6) | MSL Peak Temp<br>(3) | Op Temp (°C) | Device Marking<br>(4/5) | Samples |
|------------------|---------------|--------------|-----------------|------|-------------|-------------------------|-------------------------|----------------------|--------------|-------------------------|---------|
| OPA2234U         | LIFEBUY       | SOIC         | D               | 8    | 75          | Green (RoHS & no Sb/Br) | CU NIPDAU-DCC           | Level-3-260C-168 HR  | -40 to 85    | OPA<br>2234U            |         |
| OPA2234U/2K5     | LIFEBUY       | SOIC         | D               | 8    | 2500        | Green (RoHS & no Sb/Br) | CU NIPDAU-DCC           | Level-3-260C-168 HR  | -40 to 85    | OPA<br>2234U            |         |
| OPA2234UA        | LIFEBUY       | SOIC         | D               | 8    | 75          | Green (RoHS & no Sb/Br) | CU NIPDAU-DCC           | Level-3-260C-168 HR  | -40 to 85    | OPA<br>2234U<br>A       |         |
| OPA2234UA/2K5    | LIFEBUY       | SOIC         | D               | 8    | 2500        | Green (RoHS & no Sb/Br) | CU NIPDAU-DCC           | Level-3-260C-168 HR  | -40 to 85    | OPA<br>2234U<br>A       |         |
| OPA2234UA/2K5G4  | LIFEBUY       | SOIC         | D               | 8    | 2500        | Green (RoHS & no Sb/Br) | CU NIPDAU-DCC           | Level-3-260C-168 HR  | -40 to 85    | OPA<br>2234U<br>A       |         |
| OPA2234UG4       | LIFEBUY       | SOIC         | D               | 8    | 75          | Green (RoHS & no Sb/Br) | CU NIPDAU-DCC           | Level-3-260C-168 HR  | -40 to 85    | OPA<br>2234U            |         |
| OPA234E/250      | LIFEBUY       | VSSOP        | DGK             | 8    | 250         | Green (RoHS & no Sb/Br) | CU NIPDAU   Call TI     | Level-3-260C-168 HR  | -40 to 125   | A34                     |         |
| OPA234E/250G4    | LIFEBUY       | VSSOP        | DGK             | 8    | 250         | Green (RoHS & no Sb/Br) | Call TI                 | Level-3-260C-168 HR  | -40 to 125   | A34                     |         |
| OPA234E/2K5      | LIFEBUY       | VSSOP        | DGK             | 8    | 2500        | Green (RoHS & no Sb/Br) | CU NIPDAU   Call TI     | Level-3-260C-168 HR  | -40 to 125   | A34                     |         |
| OPA234EA/250     | LIFEBUY       | VSSOP        | DGK             | 8    | 250         | Green (RoHS & no Sb/Br) | CU NIPDAU   Call TI     | Level-3-260C-168 HR  | -40 to 125   | A34                     |         |
| OPA234EA/250G4   | LIFEBUY       | VSSOP        | DGK             | 8    | 250         | Green (RoHS & no Sb/Br) | Call TI                 | Level-3-260C-168 HR  | -40 to 125   | A34                     |         |
| OPA234EA/2K5     | LIFEBUY       | VSSOP        | DGK             | 8    | 2500        | Green (RoHS & no Sb/Br) | CU NIPDAU   Call TI     | Level-3-260C-168 HR  | -40 to 125   | A34                     |         |
| OPA234U          | LIFEBUY       | SOIC         | D               | 8    | 75          | Green (RoHS & no Sb/Br) | CU NIPDAU-DCC           | Level-3-260C-168 HR  | -40 to 125   | OPA<br>234U             |         |
| OPA234U/2K5      | LIFEBUY       | SOIC         | D               | 8    | 2500        | Green (RoHS & no Sb/Br) | CU NIPDAU-DCC           | Level-3-260C-168 HR  | -40 to 125   | OPA<br>234U             |         |
| OPA234UA         | LIFEBUY       | SOIC         | D               | 8    | 75          | Green (RoHS & no Sb/Br) | CU NIPDAU-DCC           | Level-3-260C-168 HR  | -40 to 125   | OPA<br>234U<br>A        |         |

| Orderable Device | Status<br>(1) | Package Type | Package Drawing | Pins | Package Qty | Eco Plan<br>(2)         | Lead/Ball Finish<br>(6) | MSL Peak Temp<br>(3) | Op Temp (°C) | Device Marking<br>(4/5) | Samples |
|------------------|---------------|--------------|-----------------|------|-------------|-------------------------|-------------------------|----------------------|--------------|-------------------------|---------|
| OPA234UA/2K5     | LIFEBUY       | SOIC         | D               | 8    | 2500        | Green (RoHS & no Sb/Br) | CU NIPDAU-DCC           | Level-3-260C-168 HR  | -40 to 125   | OPA<br>234U<br>A        |         |
| OPA4234U         | LIFEBUY       | SOIC         | D               | 14   | 50          | Green (RoHS & no Sb/Br) | CU NIPDAU-DCC           | Level-3-260C-168 HR  | -40 to 85    | OPA4234U                |         |
| OPA4234U/2K5     | LIFEBUY       | SOIC         | D               | 14   | 2500        | Green (RoHS & no Sb/Br) | CU NIPDAU-DCC           | Level-3-260C-168 HR  | -40 to 85    | OPA4234U                |         |
| OPA4234UA        | LIFEBUY       | SOIC         | D               | 14   | 50          | Green (RoHS & no Sb/Br) | CU NIPDAU-DCC           | Level-3-260C-168 HR  | -40 to 85    | OPA4234U<br>A           |         |
| OPA4234UA/2K5    | LIFEBUY       | SOIC         | D               | 14   | 2500        | Green (RoHS & no Sb/Br) | CU NIPDAU-DCC           | Level-3-260C-168 HR  | -40 to 85    | OPA4234U<br>A           |         |
| OPA4234UA/2K5G4  | LIFEBUY       | SOIC         | D               | 14   | 2500        | Green (RoHS & no Sb/Br) | CU NIPDAU-DCC           | Level-3-260C-168 HR  | -40 to 85    | OPA4234U<br>A           |         |
| OPA4234UAG4      | LIFEBUY       | SOIC         | D               | 14   | 50          | Green (RoHS & no Sb/Br) | CU NIPDAU-DCC           | Level-3-260C-168 HR  | -40 to 85    | OPA4234U<br>A           |         |
| OPA4234UG4       | LIFEBUY       | SOIC         | D               | 14   | 50          | Green (RoHS & no Sb/Br) | CU NIPDAU-DCC           | Level-3-260C-168 HR  | -40 to 85    | OPA4234U                |         |

(1) The marketing status values are defined as follows:

**ACTIVE:** Product device recommended for new designs.

**LIFEBUY:** TI has announced that the device will be discontinued, and a lifetime-buy period is in effect.

**NRND:** Not recommended for new designs. Device is in production to support existing customers, but TI does not recommend using this part in a new design.

**PREVIEW:** Device has been announced but is not in production. Samples may or may not be available.

**OBsolete:** TI has discontinued the production of the device.

(2) **RoHS:** TI defines "RoHS" to mean semiconductor products that are compliant with the current EU RoHS requirements for all 10 RoHS substances, including the requirement that RoHS substance do not exceed 0.1% by weight in homogeneous materials. Where designed to be soldered at high temperatures, "RoHS" products are suitable for use in specified lead-free processes. TI may reference these types of products as "Pb-Free".

**RoHS Exempt:** TI defines "RoHS Exempt" to mean products that contain lead but are compliant with EU RoHS pursuant to a specific EU RoHS exemption.

**Green:** TI defines "Green" to mean the content of Chlorine (Cl) and Bromine (Br) based flame retardants meet JS709B low halogen requirements of <=1000ppm threshold. Antimony trioxide based flame retardants must also meet the <=1000ppm threshold requirement.

(3) MSL, Peak Temp. - The Moisture Sensitivity Level rating according to the JEDEC industry standard classifications, and peak solder temperature.

(4) There may be additional marking, which relates to the logo, the lot trace code information, or the environmental category on the device.

---

<sup>(5)</sup> Multiple Device Markings will be inside parentheses. Only one Device Marking contained in parentheses and separated by a "-" will appear on a device. If a line is indented then it is a continuation of the previous line and the two combined represent the entire Device Marking for that device.

<sup>(6)</sup> Lead/Ball Finish - Orderable Devices may have multiple material finish options. Finish options are separated by a vertical ruled line. Lead/Ball Finish values may wrap to two lines if the finish value exceeds the maximum column width.

**Important Information and Disclaimer:**The information provided on this page represents TI's knowledge and belief as of the date that it is provided. TI bases its knowledge and belief on information provided by third parties, and makes no representation or warranty as to the accuracy of such information. Efforts are underway to better integrate information from third parties. TI has taken and continues to take reasonable steps to provide representative and accurate information but may not have conducted destructive testing or chemical analysis on incoming materials and chemicals. TI and TI suppliers consider certain information to be proprietary, and thus CAS numbers and other limited information may not be available for release.

In no event shall TI's liability arising out of such information exceed the total purchase price of the TI part(s) at issue in this document sold by TI to Customer on an annual basis.

**OTHER QUALIFIED VERSIONS OF OPA2234 :**

- Military: [OPA2234M](#)

NOTE: Qualified Version Definitions:

- Military - QML certified for Military and Defense Applications

**TAPE AND REEL INFORMATION**

**QUADRANT ASSIGNMENTS FOR PIN 1 ORIENTATION IN TAPE**

\*All dimensions are nominal

| Device        | Package Type | Package Drawing | Pins | SPQ  | Reel Diameter (mm) | Reel Width W1 (mm) | A0 (mm) | B0 (mm) | K0 (mm) | P1 (mm) | W (mm) | Pin1 Quadrant |
|---------------|--------------|-----------------|------|------|--------------------|--------------------|---------|---------|---------|---------|--------|---------------|
| OPA2234U/2K5  | SOIC         | D               | 8    | 2500 | 330.0              | 12.4               | 6.4     | 5.2     | 2.1     | 8.0     | 12.0   | Q1            |
| OPA2234UA/2K5 | SOIC         | D               | 8    | 2500 | 330.0              | 12.4               | 6.4     | 5.2     | 2.1     | 8.0     | 12.0   | Q1            |
| OPA234E/250   | VSSOP        | DGK             | 8    | 250  | 180.0              | 12.4               | 5.3     | 3.4     | 1.4     | 8.0     | 12.0   | Q1            |
| OPA234E/2K5   | VSSOP        | DGK             | 8    | 2500 | 330.0              | 12.4               | 5.3     | 3.4     | 1.4     | 8.0     | 12.0   | Q1            |
| OPA234EA/250  | VSSOP        | DGK             | 8    | 250  | 180.0              | 12.4               | 5.3     | 3.4     | 1.4     | 8.0     | 12.0   | Q1            |
| OPA234EA/2K5  | VSSOP        | DGK             | 8    | 2500 | 330.0              | 12.4               | 5.3     | 3.4     | 1.4     | 8.0     | 12.0   | Q1            |
| OPA234U/2K5   | SOIC         | D               | 8    | 2500 | 330.0              | 12.4               | 6.4     | 5.2     | 2.1     | 8.0     | 12.0   | Q1            |
| OPA234UA/2K5  | SOIC         | D               | 8    | 2500 | 330.0              | 12.4               | 6.4     | 5.2     | 2.1     | 8.0     | 12.0   | Q1            |
| OPA4234U/2K5  | SOIC         | D               | 14   | 2500 | 330.0              | 16.4               | 6.5     | 9.0     | 2.1     | 8.0     | 16.0   | Q1            |
| OPA4234UA/2K5 | SOIC         | D               | 14   | 2500 | 330.0              | 16.4               | 6.5     | 9.0     | 2.1     | 8.0     | 16.0   | Q1            |

**TAPE AND REEL BOX DIMENSIONS**

\*All dimensions are nominal

| Device        | Package Type | Package Drawing | Pins | SPQ  | Length (mm) | Width (mm) | Height (mm) |
|---------------|--------------|-----------------|------|------|-------------|------------|-------------|
| OPA2234U/2K5  | SOIC         | D               | 8    | 2500 | 367.0       | 367.0      | 35.0        |
| OPA2234UA/2K5 | SOIC         | D               | 8    | 2500 | 367.0       | 367.0      | 35.0        |
| OPA234E/250   | VSSOP        | DGK             | 8    | 250  | 210.0       | 185.0      | 35.0        |
| OPA234E/2K5   | VSSOP        | DGK             | 8    | 2500 | 367.0       | 367.0      | 35.0        |
| OPA234EA/250  | VSSOP        | DGK             | 8    | 250  | 210.0       | 185.0      | 35.0        |
| OPA234EA/2K5  | VSSOP        | DGK             | 8    | 2500 | 367.0       | 367.0      | 35.0        |
| OPA234U/2K5   | SOIC         | D               | 8    | 2500 | 367.0       | 367.0      | 35.0        |
| OPA234UA/2K5  | SOIC         | D               | 8    | 2500 | 367.0       | 367.0      | 35.0        |
| OPA4234U/2K5  | SOIC         | D               | 14   | 2500 | 367.0       | 367.0      | 38.0        |
| OPA4234UA/2K5 | SOIC         | D               | 14   | 2500 | 367.0       | 367.0      | 38.0        |

DGK (S-PDSO-G8)

PLASTIC SMALL-OUTLINE PACKAGE

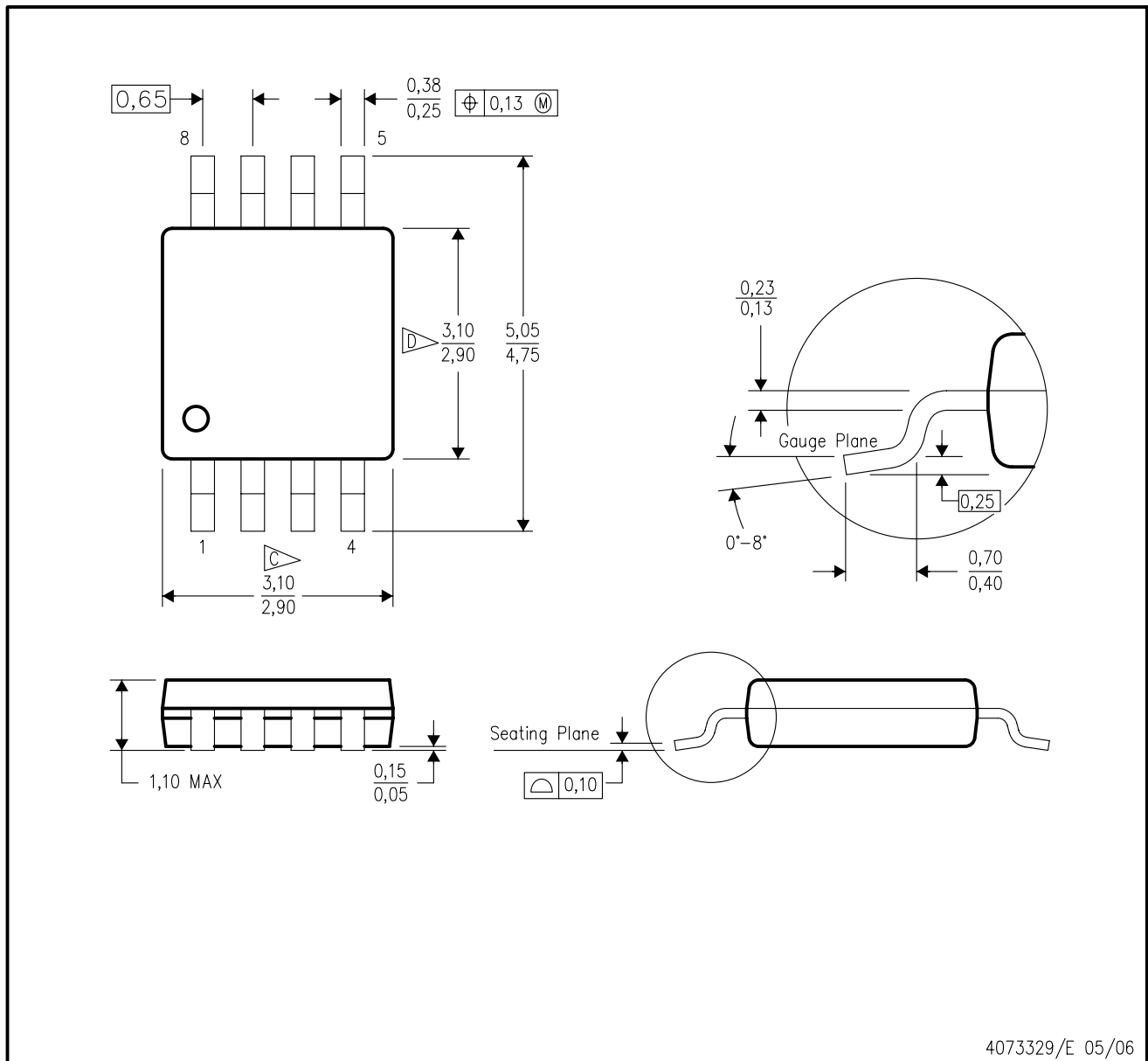

- NOTES:
- A. All linear dimensions are in millimeters.
  - B. This drawing is subject to change without notice.
  - C. Body length does not include mold flash, protrusions, or gate burrs. Mold flash, protrusions, or gate burrs shall not exceed 0.15 per end.
  - D. Body width does not include interlead flash. Interlead flash shall not exceed 0.50 per side.
  - E. Falls within JEDEC MO-187 variation AA, except interlead flash.

D (R-PDSO-G14)

PLASTIC SMALL OUTLINE



- NOTES:
- A. All linear dimensions are in inches (millimeters).
  - B. This drawing is subject to change without notice.
  - C. Body length does not include mold flash, protrusions, or gate burrs. Mold flash, protrusions, or gate burrs shall not exceed 0.006 (0,15) each side.
  - D. Body width does not include interlead flash. Interlead flash shall not exceed 0.017 (0,43) each side.
  - E. Reference JEDEC MS-012 variation AB.

D (R-PDSO-G14)

PLASTIC SMALL OUTLINE



- NOTES:
- All linear dimensions are in millimeters.
  - This drawing is subject to change without notice.
  - Publication IPC-7351 is recommended for alternate designs.
  - Laser cutting apertures with trapezoidal walls and also rounding corners will offer better paste release. Customers should contact their board assembly site for stencil design recommendations. Refer to IPC-7525 for other stencil recommendations.
  - Customers should contact their board fabrication site for solder mask tolerances between and around signal pads.



D0008A

# PACKAGE OUTLINE

SOIC - 1.75 mm max height

SMALL OUTLINE INTEGRATED CIRCUIT



4214825/C 02/2019

NOTES:

1. Linear dimensions are in inches [millimeters]. Dimensions in parenthesis are for reference only. Controlling dimensions are in inches. Dimensioning and tolerancing per ASME Y14.5M.
2. This drawing is subject to change without notice.
3. This dimension does not include mold flash, protrusions, or gate burrs. Mold flash, protrusions, or gate burrs shall not exceed  $.006$  [0.15] per side.
4. This dimension does not include interlead flash.
5. Reference JEDEC registration MS-012, variation AA.

# EXAMPLE BOARD LAYOUT

D0008A

SOIC - 1.75 mm max height

SMALL OUTLINE INTEGRATED CIRCUIT



LAND PATTERN EXAMPLE  
EXPOSED METAL SHOWN  
SCALE:8X



SOLDER MASK DETAILS

4214825/C 02/2019

NOTES: (continued)

6. Publication IPC-7351 may have alternate designs.

7. Solder mask tolerances between and around signal pads can vary based on board fabrication site.

# EXAMPLE STENCIL DESIGN

D0008A

SOIC - 1.75 mm max height

SMALL OUTLINE INTEGRATED CIRCUIT



SOLDER PASTE EXAMPLE  
BASED ON .005 INCH [0.125 MM] THICK STENCIL  
SCALE:8X

4214825/C 02/2019

NOTES: (continued)

8. Laser cutting apertures with trapezoidal walls and rounded corners may offer better paste release. IPC-7525 may have alternate design recommendations.
9. Board assembly site may have different recommendations for stencil design.

## IMPORTANT NOTICE AND DISCLAIMER

TI PROVIDES TECHNICAL AND RELIABILITY DATA (INCLUDING DATASHEETS), DESIGN RESOURCES (INCLUDING REFERENCE DESIGNS), APPLICATION OR OTHER DESIGN ADVICE, WEB TOOLS, SAFETY INFORMATION, AND OTHER RESOURCES "AS IS" AND WITH ALL FAULTS, AND DISCLAIMS ALL WARRANTIES, EXPRESS AND IMPLIED, INCLUDING WITHOUT LIMITATION ANY IMPLIED WARRANTIES OF MERCHANTABILITY, FITNESS FOR A PARTICULAR PURPOSE OR NON-INFRINGEMENT OF THIRD PARTY INTELLECTUAL PROPERTY RIGHTS.

These resources are intended for skilled developers designing with TI products. You are solely responsible for (1) selecting the appropriate TI products for your application, (2) designing, validating and testing your application, and (3) ensuring your application meets applicable standards, and any other safety, security, or other requirements. These resources are subject to change without notice. TI grants you permission to use these resources only for development of an application that uses the TI products described in the resource. Other reproduction and display of these resources is prohibited. No license is granted to any other TI intellectual property right or to any third party intellectual property right. TI disclaims responsibility for, and you will fully indemnify TI and its representatives against, any claims, damages, costs, losses, and liabilities arising out of your use of these resources.

TI's products are provided subject to TI's Terms of Sale ([www.ti.com/legal/termsofsale.html](http://www.ti.com/legal/termsofsale.html)) or other applicable terms available either on [ti.com](http://ti.com) or provided in conjunction with such TI products. TI's provision of these resources does not expand or otherwise alter TI's applicable warranties or warranty disclaimers for TI products.

Mailing Address: Texas Instruments, Post Office Box 655303, Dallas, Texas 75265  
Copyright © 2019, Texas Instruments Incorporated

## Looking for pricing, stock, or lifecycle information?

Click below to explore more details on WIN SOURCE:

 [View OPA4234U/2K5G4 on WIN SOURCE](#)

 [Texas Instruments](#) Information

## Optimize Your Supply Chain with WIN SOURCE Solutions

-  Global Sourcing Solution
-  Obsolete Management
-  Cost Control Management
-  Shortage Management
-  Alternative Solution
-  Excess Inventory Management