



# THE DATASHEET OF P4SMA440A



### P4SMA Series



Agency Approvals	
AGENCY	AGENCY FILE NUMBER
	E230531

Maximum Ratings and Thermal Characteristics (T <sub>A</sub> =25°C unless otherwise noted)			
Parameter	Symbol	Value	Unit
Peak Pulse Power Dissipation at T <sub>A</sub> =25°C by 10/1000µs Waveform (Fig.2)(Note 1), (Note 2), (Note 5)	P <sub>PPM</sub>	400	W
Power Dissipation on Infinite Heat Sink at T <sub>L</sub> =50°C	P <sub>D</sub>	3.3	W
Peak Forward Surge Current, 8.3ms Single Half Sine Wave (Note 3)	I <sub>FSM</sub>	60	A
Maximum Instantaneous Forward Voltage at 25A for Unidirectional Only (Note 4)	V <sub>F</sub>	3.5/5.0	V
Operating Temperature Range	T <sub>J</sub>	-65 to 150	°C
Storage Temperature Range	T <sub>STG</sub>	-65 to 175	°C
Typical Thermal Resistance Junction to Lead	R <sub>θJL</sub>	30	°C/W
Typical Thermal Resistance Junction to Ambient	R <sub>θJA</sub>	120	°C/W

- Notes:**
1. Non-repetitive current pulse, per Fig.4 and derated above T<sub>J</sub> (initial) =25°C per Fig. 3.
  2. Mounted on 5.0x5.0mm copper pad to each terminal.
  3. Measured on 8.3ms single half sine wave or equivalent square wave for unidirectional device only.
  4. V<sub>F</sub> < 3.5V for single die parts and V<sub>F</sub>< 5.0V for stacked-die parts.
  5. The P<sub>PPM</sub> of stacked-die parts is 600W and please contact littelfuse for the detail stacked-die parts.

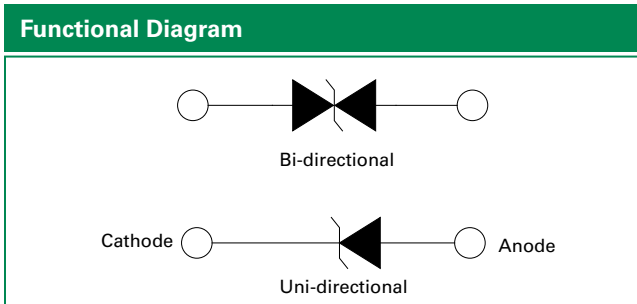

### Description

The P4SMA series is designed specifically to protect sensitive electronic equipment from voltage transients induced by lightning and other transient voltage events.

### Features

- 400W peak pulse power capability at 10/1000µs waveform, repetition rate (duty cycles):0.01 %
- Excellent clamping capability
- Low incremental surge resistance
- Typical I<sub>R</sub> less than 1µA when V<sub>BR</sub> min>12V
- Optimized surface mount footprint for minimal PCB space impact
- Low profile package
- Typical failure mode due to exceeding maximum ratings is a short circuit condition
- Whisker test conducted based on Table 4a and 4c of JEDEC JESD201A
- IEC-61000-4-2 ESD 30kV(Air), 30kV (Contact)
- EFT protection of data lines in accordance with IEC 61000-4-4
- Built-in strain relief
- Fast response time: typically less than 1.0ps from 0V to BV min
- High temperature to reflow soldering guaranteed: 260°C/40sec
- V<sub>BR</sub> @ T<sub>J</sub>=V<sub>BR</sub> @25°C x (1+α T x (T<sub>J</sub> - 25)) (α T:Temperature Coefficient, typical value is 0.1%)
- UL Recognized epoxy meeting flammability classification V-0
- Meet MSL level1, per J-STD-020, LF maximum peak of 260°C
- Matte tin lead-free Plated
- Halogen-free and RoHS compliant
- Pb-free E3 means 2nd level interconnect is Pb-free and the terminal finish material is tin(Sn) (IPC/JEDEC J-STD-609A.01)

### Applications

TVS devices are ideal for the protection of I/O Interfaces, V<sub>CC</sub> bus and other vulnerable circuits used in Telecom, Computer, Industrial and Consumer electronic applications.

### Additional Information



Datashheet



Resources



Samples

# Transient Voltage Suppression Diodes

Surface Mount – 400W > P4SMA series

## Electrical Characteristics (T<sub>A</sub>=25°C unless otherwise noted)

Part Number (Uni)	Part Number (Bi)	Marking		Reverse Stand off Voltage V <sub>R</sub> (Volts)	Breakdown Voltage V <sub>BR</sub> (Volts) @ I <sub>T</sub>		Test Current I <sub>T</sub> (mA)	Maximum Clamping Voltage V <sub>C</sub> @ I <sub>PP</sub> (V)	Maximum Peak Pulse Current I <sub>PP</sub> (A)	Maximum Reverse Leakage I <sub>R</sub> @ V <sub>R</sub> (μA)	Maximum Temperature Coefficient of V <sub>BR</sub> (%/°C)	Agency Approval 
		UNI	BI		MIN	MAX						
P4SMA6.8A	P4SMA6.8CA	6V8A	6V8C	5.80	6.45	7.14	10	10.5	39.0	1000	0.041	X
P4SMA7.5A	P4SMA7.5CA	7V5A	7V5C	6.40	7.13	7.88	10	11.3	36.3	500	0.052	X
P4SMA8.2A	P4SMA8.2CA	8V2A	8V2C	7.02	7.79	8.61	10	12.1	33.9	200	0.058	X
P4SMA9.1A	P4SMA9.1CA	9V1A	9V1C	7.78	8.65	9.55	1	13.4	30.6	50	0.063	X
P4SMA10A	P4SMA10CA	10A	10C	8.55	9.50	10.50	1	14.5	28.3	10	0.066	X
P4SMA11A	P4SMA11CA	11A	11C	9.40	10.50	11.60	1	15.6	26.3	5	0.069	X
P4SMA12A	P4SMA12CA	12A	12C	10.20	11.40	12.60	1	16.7	24.6	5	0.071	X
P4SMA13A	P4SMA13CA	13A	13C	11.10	12.40	13.70	1	18.2	22.5	1	0.074	X
P4SMA15A	P4SMA15CA	15A	15C	12.80	14.30	15.80	1	21.2	19.3	1	0.076	X
P4SMA16A	P4SMA16CA	16A	16C	13.60	15.20	16.80	1	22.5	18.2	1	0.080	X
P4SMA18A	P4SMA18CA	18A	18C	15.30	17.10	18.90	1	25.5	16.1	1	0.083	X
P4SMA20A	P4SMA20CA	20A	20C	17.10	19.00	21.00	1	27.7	14.8	1	0.085	X
P4SMA22A	P4SMA22CA	22A	22C	18.80	20.90	23.10	1	30.6	13.4	1	0.088	X
P4SMA24A	P4SMA24CA	24A	24C	20.50	22.80	25.20	1	33.2	12.3	1	0.091	X
P4SMA27A	P4SMA27CA	27A	27C	23.10	25.70	28.40	1	37.5	10.9	1	0.092	X
P4SMA30A	P4SMA30CA	30A	30C	25.60	28.50	31.50	1	41.4	9.9	1	0.093	X
P4SMA33A	P4SMA33CA	33A	33C	28.20	31.40	34.70	1	45.7	9.0	1	0.094	X
P4SMA36A	P4SMA36CA	36A	36C	30.80	34.20	37.80	1	49.9	8.2	1	0.096	X
P4SMA39A	P4SMA39CA	39A	39C	33.30	37.10	41.00	1	53.9	7.6	1	0.097	X
P4SMA43A	P4SMA43CA	43A	43C	36.80	40.90	45.20	1	59.3	6.9	1	0.098	X
P4SMA47A	P4SMA47CA	47A	47C	40.20	44.70	49.40	1	64.8	6.3	1	0.099	X
P4SMA51A	P4SMA51CA	51A	51C	43.60	48.50	53.60	1	70.1	5.8	1	0.100	X
P4SMA56A	P4SMA56CA	56A	56C	47.80	53.20	58.80	1	77.0	5.3	1	0.101	X
P4SMA62A	P4SMA62CA	62A	62C	53.00	58.90	65.10	1	85.0	4.8	1	0.102	X
P4SMA68A	P4SMA68CA	68A	68C	58.10	64.60	71.40	1	92.0	4.5	1	0.103	X
P4SMA75A	P4SMA75CA	75A	75C	64.10	71.30	78.80	1	103.0	4.0	1	0.104	X
P4SMA82A	P4SMA82CA	82A	82C	70.10	77.90	86.10	1	113.0	3.6	1	0.105	X
P4SMA91A	P4SMA91CA	91A	91C	77.80	86.50	95.50	1	125.0	3.3	1	0.106	X
P4SMA100A	P4SMA100CA	100A	100C	85.50	95.00	105.00	1	137.0	3.0	1	0.106	X
P4SMA110A	P4SMA110CA	110A	110C	94.00	105.00	116.00	1	152.0	2.7	1	0.107	X
P4SMA120A	P4SMA120CA	120A	120C	102.00	114.00	126.00	1	165.0	2.5	1	0.107	X
P4SMA130A	P4SMA130CA	130A	130C	111.00	124.00	137.00	1	179.0	2.3	1	0.107	X
P4SMA150A	P4SMA150CA	150A	150C	128.00	143.00	158.00	1	207.0	2.0	1	0.108	X
P4SMA160A	P4SMA160CA	160A	160C	136.00	152.00	168.00	1	219.0	1.9	1	0.108	X
P4SMA170A	P4SMA170CA	170A	170C	145.00	162.00	179.00	1	234.0	1.8	1	0.108	X
P4SMA180A	P4SMA180CA	180A	180C	154.00	171.00	189.00	1	246.0	1.7	1	0.108	X
P4SMA200A	P4SMA200CA	200A	200C	171.00	190.00	210.00	1	274.0	1.5	1	0.108	X
P4SMA220A	P4SMA220CA	220A	220C	185.00	209.00	231.00	1	328.0	1.3	1	0.110	
P4SMA250A	-	250A	-	214.00	237.00	263.00	1	344.0	1.2	1	0.110	
	P4SMA250CA*		250C	214.00	237.00	263.00	1	344.0	2.2	1	0.110	
P4SMA300A	-	300A	-	256.00	285.00	315.00	1	414.0	1.0	1	0.110	
	P4SMA300CA*		300C	256.00	285.00	315.00	1	414.0	1.8	1	0.110	
P4SMA350A*	P4SMA350CA*	350A	350C	300.00	332.00	368.00	1	482.0	0.9	1	0.112	
P4SMA400A*	P4SMA400CA*	400A	400C	342.00	380.00	420.00	1	548.0	0.8	1	0.112	
P4SMA440A*	P4SMA440CA*	440A	440C	376.00	418.00	462.00	1	602.0	0.7	1	0.112	
P4SMA480A*	P4SMA480CA*	480A	480C	408.00	456.00	504.00	1	658.0	0.6	1	0.112	
P4SMA510A*	P4SMA510CA*	510A	510C	434.00	485.00	535.00	1	698.0	0.6	1	0.112	
P4SMA530A*	P4SMA530CA*	530A	530C	451.00	503.50	556.50	1	725.0	0.6	1	0.112	
P4SMA540A*	P4SMA540CA*	540A	540C	460.00	513.00	567.00	1	740.0	0.5	1	0.112	
P4SMA550A*	P4SMA550CA*	550A	550C	468.00	522.50	577.50	1	760.0	0.5	1	0.112	

For bidirectional type having V<sub>R</sub> of 10 volts and less, the I<sub>R</sub> limit is double.  
 For parts without A, the V<sub>BR</sub> is ± 10% and V<sub>C</sub> is 5% higher than with A parts

**I-V Curve Characteristics**

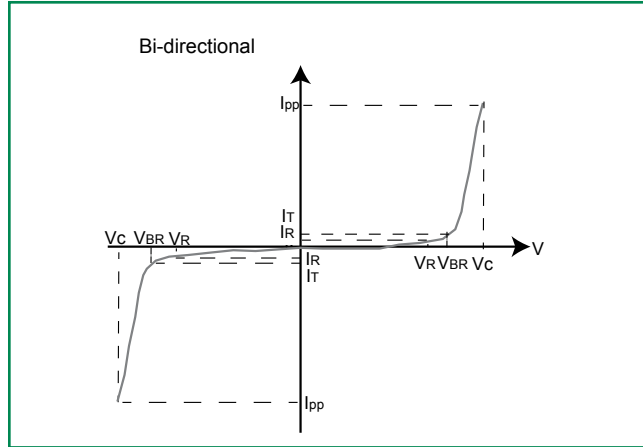
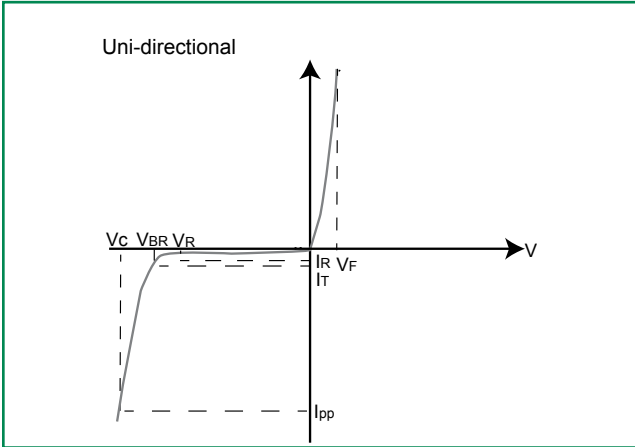

- $P_{PPM}$  Peak Pulse Power Dissipation** – Max power dissipation
- $V_R$  Stand-off Voltage** – Maximum voltage that can be applied to the TVS without operation
- $V_{BR}$  Breakdown Voltage** – Maximum voltage that flows through the TVS at a specified test current ( $I_T$ )
- $V_C$  Clamping Voltage** – Peak voltage measured across the TVS at a specified  $I_{ppm}$  (peak impulse current)
- $I_R$  Reverse Leakage Current** – Current measured at  $V_R$
- $V_F$  Forward Voltage Drop for Uni-directional**

**Ratings and Characteristic Curves** ( $T_A=25^\circ\text{C}$  unless otherwise noted)

**Figure 1 - TVS Transients Clamping Waveform**

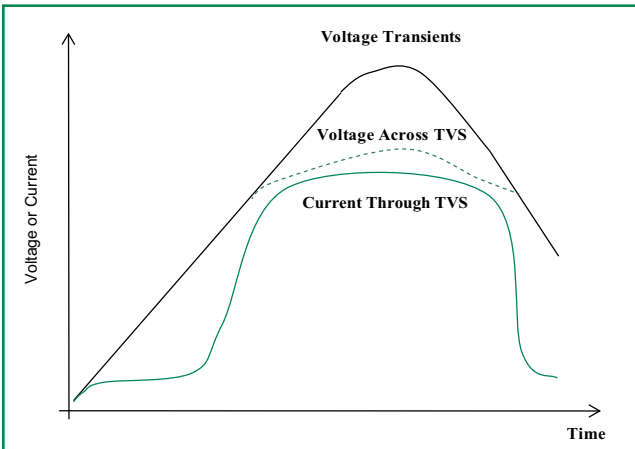

**Figure 2 - Peak Pulse Power Rating Curve**

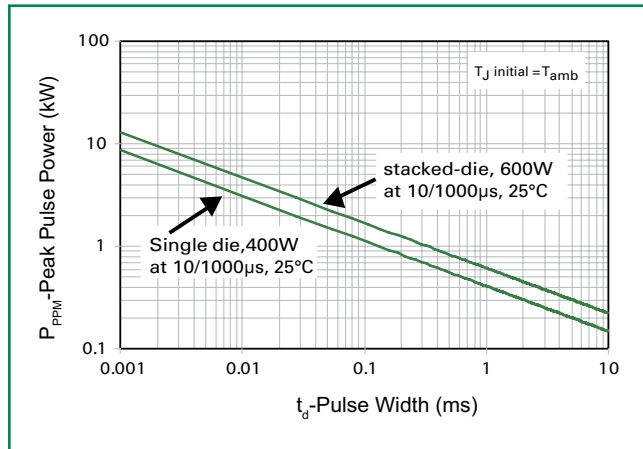

continues on next page.

### Ratings and Characteristic Curves ( $T_A=25^\circ\text{C}$ unless otherwise noted) (Continued)

#### Figure 3 - Peak Pulse Power Derating Curve

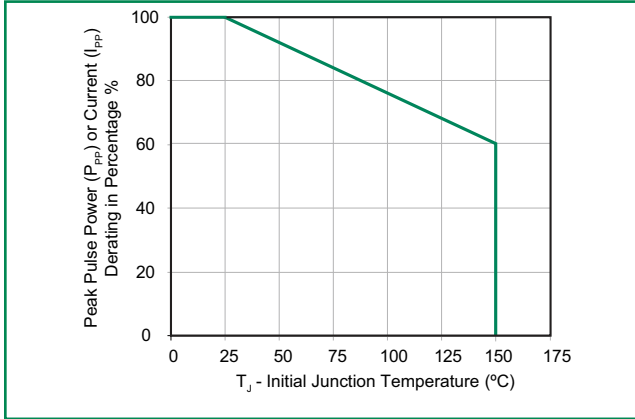

#### Figure 4 - Pulse Waveform

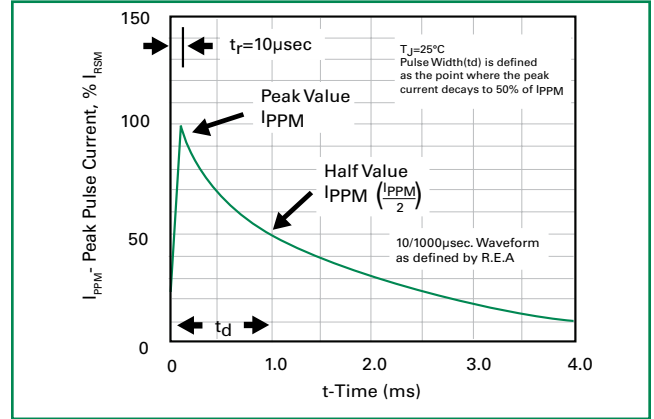

#### Figure 5 - Typical Junction Capacitance

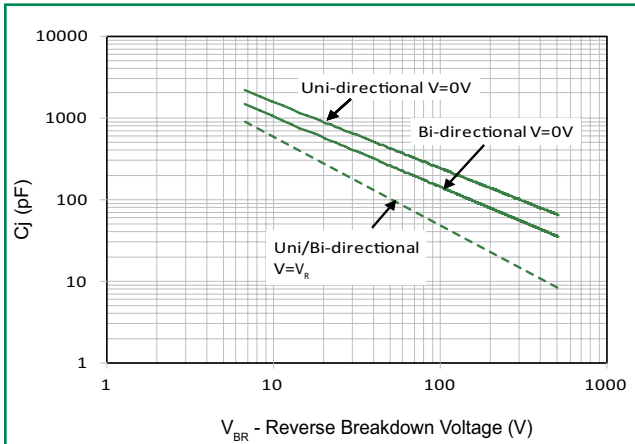

#### Figure 6 - Typical Transient Thermal Impedance

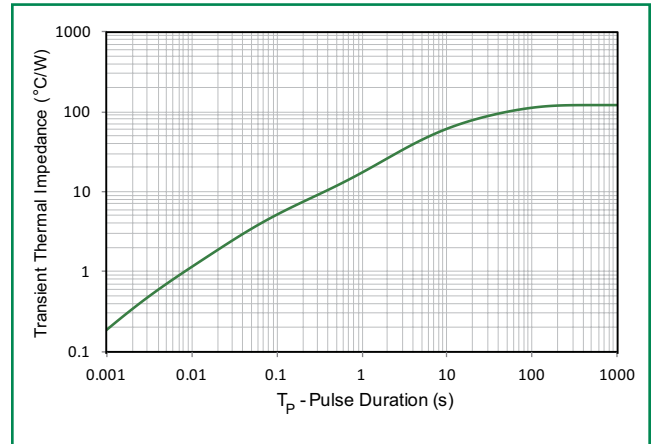

#### Figure 7 - Maximum Non-Repetitive Forward Surge Current Uni-Directional Only

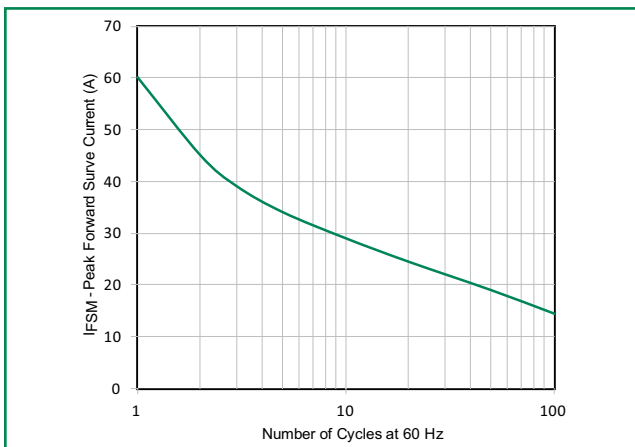

#### Figure 8 - Peak Forward Voltage Drop vs Peak Forward Current (Typical Values)

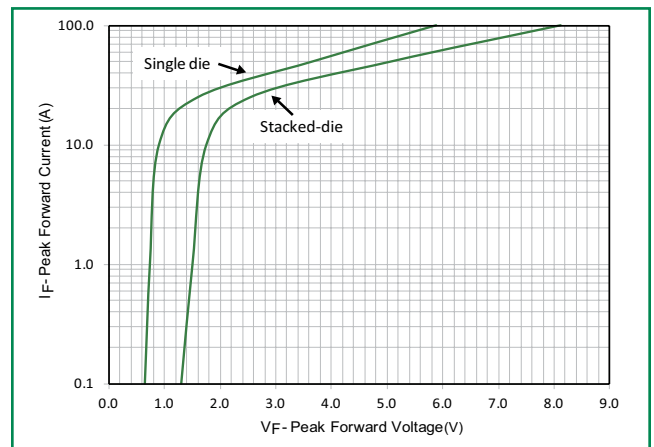

**Soldering Parameters**

Reflow Condition		Lead-free assembly
Pre Heat	- Temperature Min ( $T_{s(min)}$ )	150°C
	- Temperature Max ( $T_{s(max)}$ )	200°C
	- Time (min to max) ( $t_s$ )	60 – 180 secs
Average ramp up rate (Liquidus Temp ( $T_A$ ) to peak)		3°C/second max
$T_{s(max)}$ to $T_A$ - Ramp-up Rate		3°C/second max
Reflow	- Temperature ( $T_A$ ) (Liquidus)	217°C
	- Time (min to max) ( $t_s$ )	60 – 150 seconds
Peak Temperature ( $T_p$ )		260 <sup>+0/-5</sup> °C
Time within 5°C of actual peak Temperature ( $t_p$ )		20 – 40 seconds
Ramp-down Rate		6°C/second max
Time 25°C to peak Temperature ( $T_p$ )		8 minutes Max.
Do not exceed		260°C

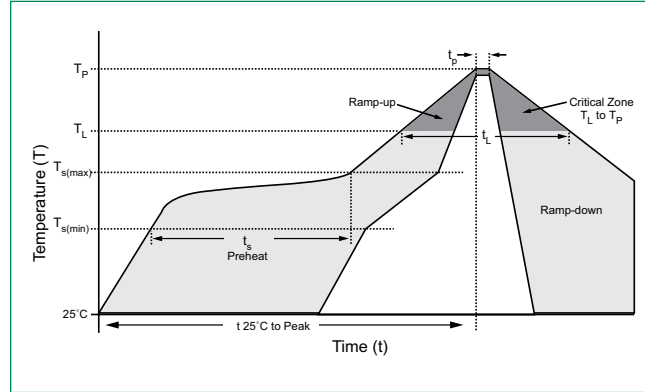

**Physical Specifications**

<b>Weight</b>	0.002 ounce, 0.061 gram
<b>Case</b>	JEDEC DO-214AC. Molded plastic body over glass passivated junction
<b>Polarity</b>	Color band denotes positive end (cathode) except bidirectional
<b>Terminal</b>	Matte Tin-plated leads, Solderable per JESD22-B102

**Environmental Specifications**

<b>High Temp. Storage</b>	JESD22-A103
<b>HTRB</b>	JESD22-A108
<b>Temperature Cycling</b>	JESD22-A104
<b>MSL</b>	JEDEC-J-STD-020, Level 1
<b>H3TRB</b>	JESD22-A101
<b>RSH</b>	JESD22-A111

**Dimensions**

**DO-214AC (SMA)**

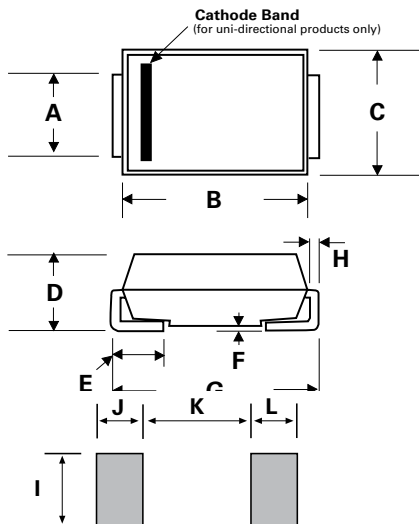

Dimensions	Inches		Millimeters	
	Min	Max	Min	Max
A	0.049	0.065	1.250	1.650
B	0.157	0.181	3.990	4.600
C	0.095	0.110	2.400	2.790
D	0.075	0.090	1.900	2.290
E	0.030	0.060	0.780	1.520
F	-	0.008	-	0.203
G	0.189	0.208	4.800	5.280
H	0.006	0.012	0.152	0.305
I	0.070	-	1.800	-
J	0.082	-	2.100	-
K	-	0.090	-	2.300
L	0.082	-	2.100	-

### Part Numbering System

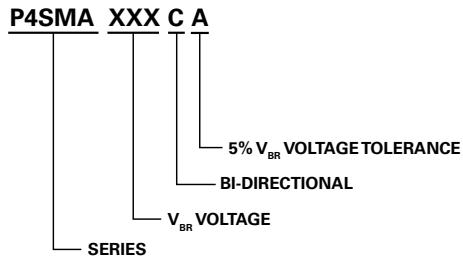

### Part Marking System

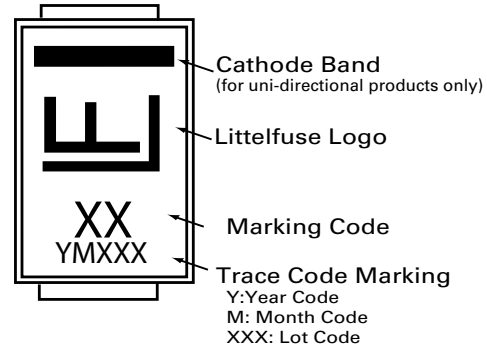

### Packaging

Part number	Component Package	Quantity	Packaging Option	Packaging Specification
P4SMAxxxXX	DO-214AC	5000	Tape & Reel - 12mm tape/13" reel	EIA STD RS-481

### Tape and Reel Specification

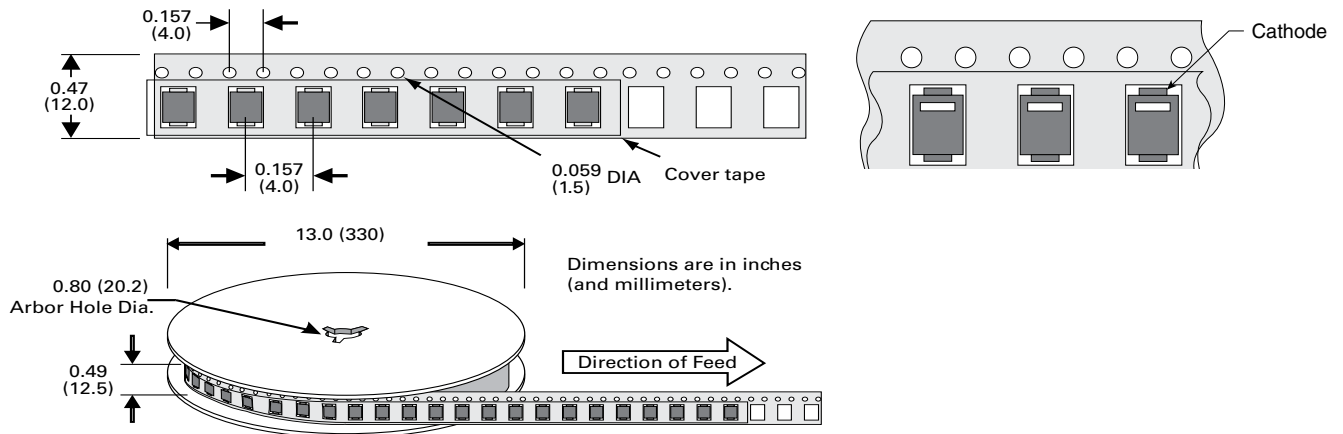

**Disclaimer Notice - Information furnished is believed to be accurate and reliable. However, users should independently evaluate the suitability of and test each product selected for their own applications. Littelfuse products are not designed for, and may not be used in, all applications. Read complete Disclaimer Notice at [www.littelfuse.com/disclaimer-electronics](http://www.littelfuse.com/disclaimer-electronics).**

## Looking for pricing, stock, or lifecycle information?

Click below to explore more details on WIN SOURCE:

 [View P4SMA440A on WIN SOURCE](#)

 [Littelfuse Inc. Information](#)

## Optimize Your Supply Chain with WIN SOURCE Solutions

-  Global Sourcing Solution
-  Obsolete Management
-  Cost Control Management
-  Shortage Management
-  Alternative Solution
-  Excess Inventory Management