



**THE DATASHEET OF
PA1314NLT**



SMT POWER INDUCTORS

Power Beads - PA131xNL Series Coupled Inductors

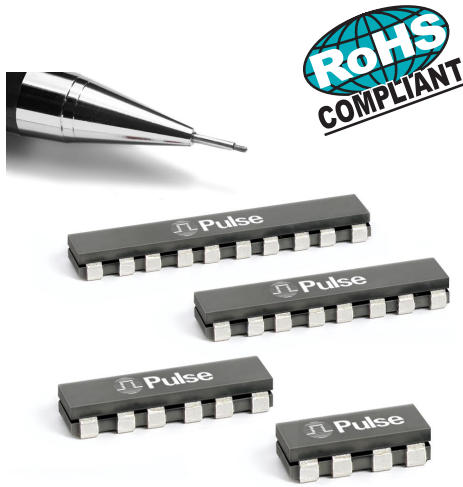
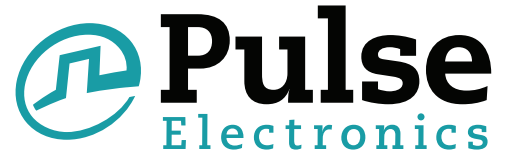

- Gen 1.0 Coupled Inductors (2,3,4 and 5 phases)
- For use only with Volterra chipsets
- Coupled Inductors enable:
 - Phase ripple current reduction due to AC magnetic field cancellation within the inductor core
 - Improved efficiency due to lower peak currents
 - Reduction in required output capacitance
- Halogen Free

Electrical Specifications @ 25°C — Operating Temperature -40°C to +130°C

Pulse Part No.	Number of Coupled Phases	Equivalent ¹ Transient Inductance per Phase (nH ±20%)	Rated ² per Phase (A _{dc})	Open Circuit Ind. per Phase ³ nH ±20%, 0A _{dc}					Open Circuit Ind. per Phase ³ nH Min, 5A _{dc}					DCR/Phase ⁴ (mΩ)	
				L1	L2	L3	L4	L5	L1	L2	L3	L4	L5	TYP	MAX
				(1-2)	(3-4)	(5-6)	(7-8)	(9-10)	(1-2)	(3-4)	(5-6)	(7-8)	(9-10)		
PA1312NL	2	50	40	310	310	-	-	-	240	240	-	-	-	0.425	0.5
PA1313NL	3	50	40	370	450	370	-	-	285	350	285	-	-		
PA1314NL	4	50	40	370	490	490	370	-	285	385	385	285	-		
PA1315NL	5	50	40	370	470	490	470	390	285	365	385	365	285		

Notes

1. In a non-coupled multi-phase topology, the power supply sees the same inductance during transient and steady-state conditions. As a result, any attempt to lower the inductance to improve transient response has the negative result of increasing ripple and peak currents throughout the system during steady-state operation. However, in a coupled inductor multi-phase topology, the interaction of magnetic fields from each phase enables an overall reduction in ripple current during steady-state operation and a lower equivalent inductance during transient operation. The equivalent transient inductance per phase, as listed, represents the actual value of inductance that would be required in a non-coupled topology to realize the same transient performance. This value is achieved by core and winding geometry and is not directly

measured by Pulse. For more information on the operation of the coupled inductor topology, please contact Volterra.

2. The rated current per phase is based on Volterra's testing of the Pulse coupled inductors.

3. The open-circuit inductance per phase is the measured inductance (at specified current) across each phase when all other phases are open-circuit. The open circuit inductance is equal to the magnetizing inductance per phase (L_m) plus the equivalent transient inductance (L_k).

4. The nominal value of DCR/phase is for reference only. For production testing, the maximum limit is used.

Mechanical

Schematic

PA1312NL

SUGGESTED PAD LAYOUT

Weight 3.0 grams
 Tape & Reel . . . 650/reel
 Tray 60/tray

Dimensions: $\frac{\text{Inches}}{\text{mm}}$

Unless otherwise specified, all tolerances are $\pm \frac{.010}{0.25}$

TAPE & REEL LAYOUT

USER DIRECTION OF FEED

SMT POWER INDUCTORS

Power Beads - PA131xNL Series Coupled Inductors

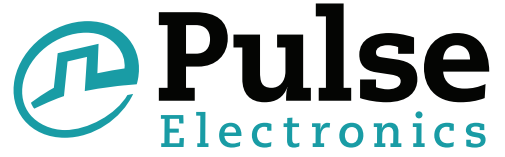

Mechanical

Schematic

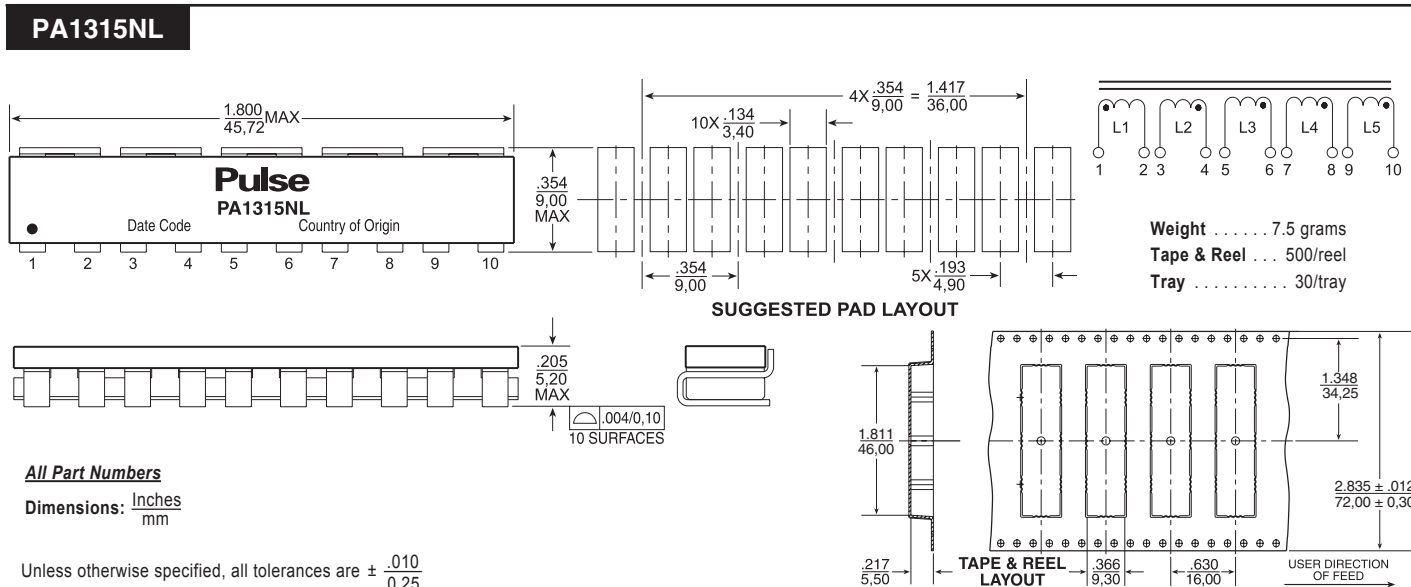
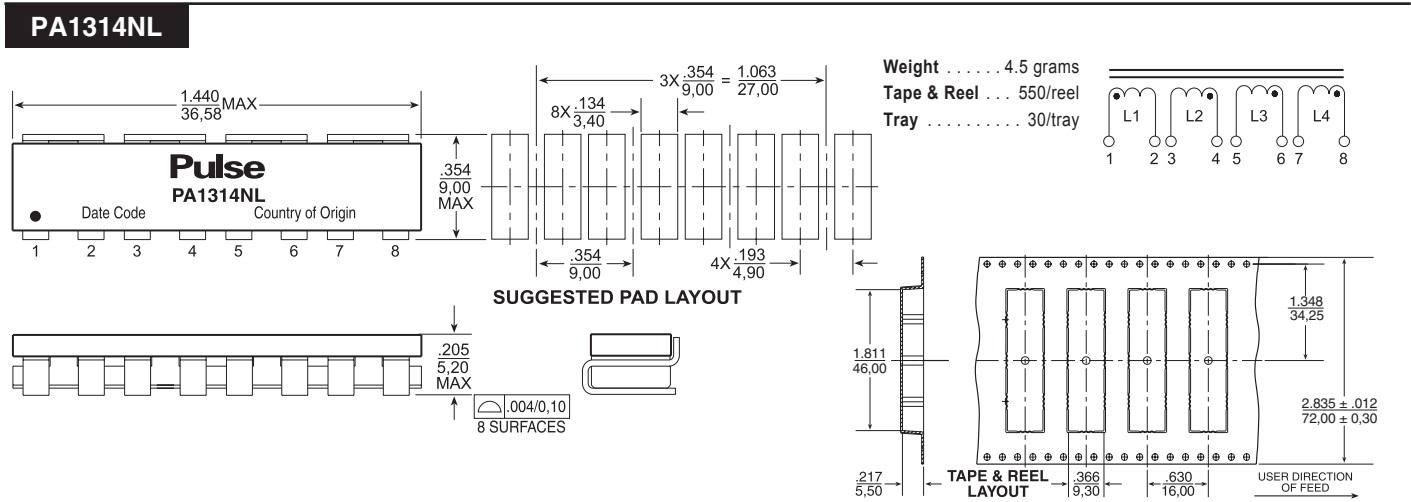
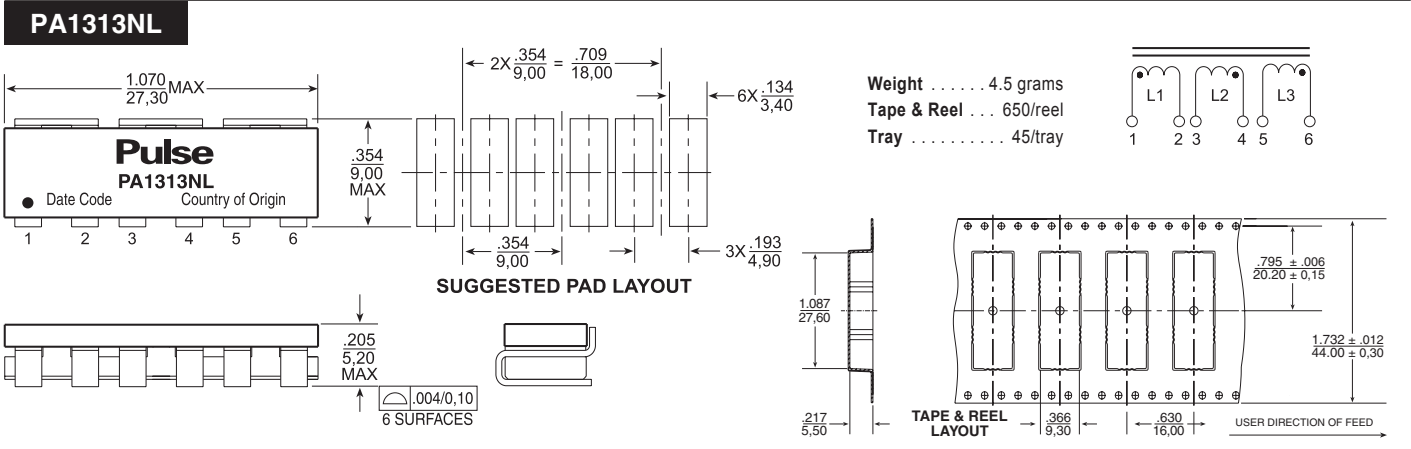

All Part Numbers

Dimensions: $\frac{\text{Inches}}{\text{mm}}$

Unless otherwise specified, all tolerances are $\pm \frac{.010}{0,25}$

Looking for pricing, stock, or lifecycle information?

Click below to explore more details on WIN SOURCE:

 [View PA1314NLT on WIN SOURCE](#)

 [Pulse Information](#)

Optimize Your Supply Chain with WIN SOURCE Solutions

-  Global Sourcing Solution
-  Obsolete Management
-  Cost Control Management
-  Shortage Management
-  Alternative Solution
-  Excess Inventory Management