



**THE DATASHEET OF
PAM3101HCA180**



Description

The PAM3101 series of positive voltage linear regulators feature low quiescent current (65µA typ.) and low dropout voltage, making them ideal for battery powered applications. Their high PSRR make them useful in applications where AC noise on the input power supply must be suppressed. Space-saving SOT-23, SOT-89, SC70 and DFN1.6x1.6-6L packages are attractive for portable and handheld applications. They have both thermal shutdown and current limit features to prevent device failure from extreme operating conditions. They are stable with an output capacitor of 2.2µF or greater.

Features

- Low Dropout Voltage: 180mV@300mA ($V_O = 3.3V$)
- Output Voltage Accuracy within $\pm 2\%$
- Supply Voltage Range: 2.5V to 5.5V
- Quiescent Current: 65µA typ.
- High PSRR: 70dB@1kHz
- Excellent Line and Regulation
- Fast Discharge
- Current Limiting
- Short Circuit Protection
- Low Temperature Coefficient
- Shutdown Current: 0.5µA
- Thermal Shutdown
- Space Saving Packages: SOT-23, SOT-89, SC70 and DFN1.6x1.6
- Pb-Free Packages

Applications

- Cellular Phones
- Bluetooth Earphones
- Digital Cameras
- Portable Electronics
- WLANs
- MP3 Players

Pin Assignments

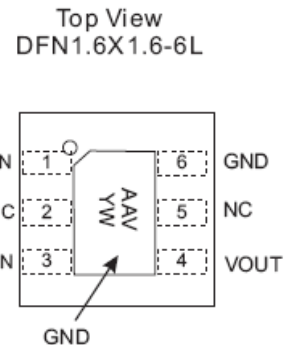
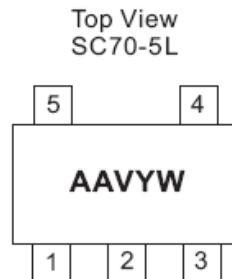
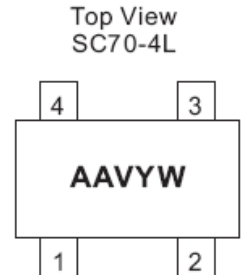
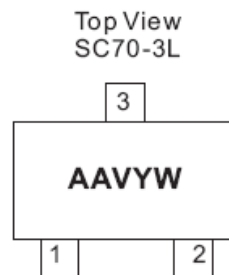
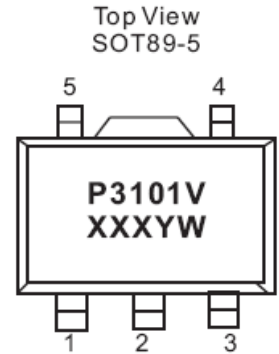
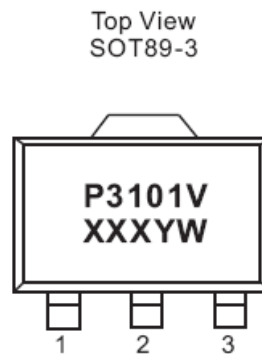
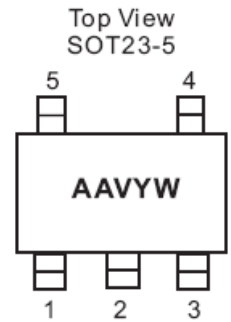
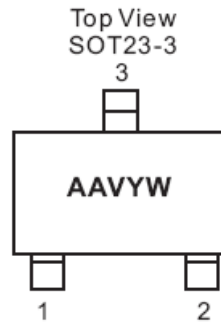

Typical Applications Circuit

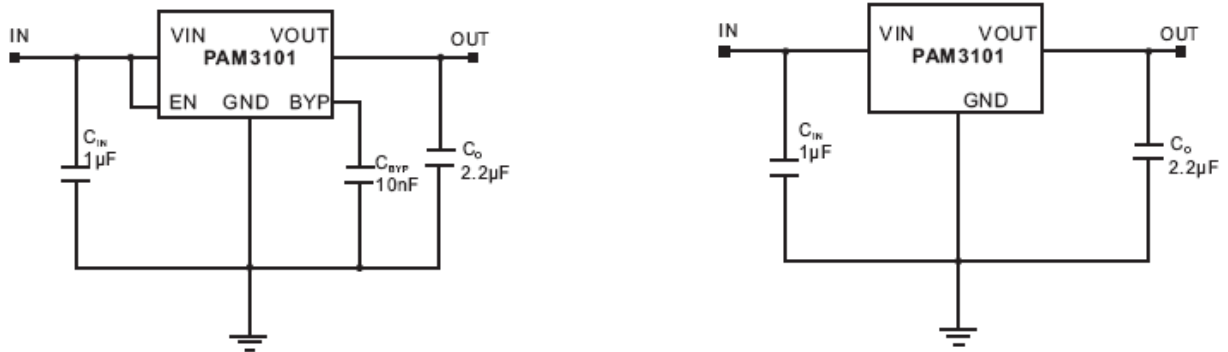

Pin Configuration and Description

| Package Type | Pin Number | | | | | |
|---------------|------------|------|------|------|------|-----|
| | 1 | 2 | 3 | 4 | 5 | 6 |
| SOT23-3 | GND | VOUT | VIN | — | — | — |
| | VIN | VOUT | GND | — | — | — |
| | VOUT | GND | VIN | — | — | — |
| SOT23-5 | VIN | GND | EN | BYP | VOUT | — |
| | VIN | GND | EN | NC | VOUT | — |
| SOT89-3 | GND | VIN | VOUT | — | — | — |
| | VOUT | GND | VIN | — | — | — |
| SOT89-5 | VOUT | GND | NC | EN | VIN | — |
| SC-70-3L | VIN | VOUT | GND | — | — | — |
| SC70-4L | EN | GND | VOUT | VIN | — | — |
| SC70-5L | VIN | GND | EN | BYP | VOUT | — |
| DFN1.6x1.6-6L | EN | NC | VIN | VOUT | NC | GND |

| Pin Name | Function |
|----------|---|
| VIN | Input |
| GND | Ground |
| VOUT | Output |
| EN | Chip Enable (active high) PAM3101BABXX---EN default floating Other part no---EN default pull high |
| BYP | Bypass Pin, need a 10nF capacitor connect to GND |
| NC | No Connection |

Functional Block Diagram



Absolute Maximum Ratings (@T_A = +25°C, unless otherwise specified.)

These are stress ratings only and functional operation is not implied. Exposure to absolute maximum ratings for prolonged time periods may affect device reliability. All voltages are with respect to ground.

| Parameter | Rating | Unit |
|----------------------------|-----------------------------------|------|
| Input Voltage | 6.0 | V |
| Output Current | 300 | mA |
| Output Pin Voltage | GND -0.3 to V _{IN} +0.3V | V |
| Lead Soldering Temperature | 300, (5sec) | °C |
| Storage Temperature | -65 to +150 | °C |
| ESD Rating | Class B | — |

Recommended Operating Conditions (@T_A = +25°C, unless otherwise specified.)

| Parameter | Rating | Unit |
|-----------------------|-------------|------|
| Supply Voltage Range | 2.5 to 5.5 | V |
| Junction Temperature | -40 to +125 | °C |
| Operation Temperature | -40 to +85 | |

Thermal Information

| Parameter | Symbol | Package | Max | Unit |
|---|---------------|------------|-----|------|
| Thermal Resistance Junction to Case) | θ_{JC} | SOT23 | 130 | °C/W |
| | | SOT-89 | 100 | |
| | | SC70 | 160 | |
| | | DFN1.6x1.6 | 65 | |
| Thermal Resistance (Junction to Ambient) | θ_{JA} | SOT23 | 250 | |
| | | SOT-89 | 180 | |
| | | SC70 | 300 | |
| | | DFN1.6x1.6 | 175 | |
| Internal Power Dissipation (@ $T_A = +25^\circ\text{C}$) | P_D | SOT23 | 400 | mW |
| | | SOT-89 | 550 | |
| | | SC70 | 300 | |
| | | DFN1.6x1.6 | 570 | |

Electrical Characteristics (@ $T_A = +25^\circ\text{C}$, $V_{CE1} = V_{CE2} = V_{IN} = V_O + 1V$, $C_{IN} = 2.2\mu\text{F}$, $C_O = 2.2\mu\text{F}$, unless otherwise specified.)

| Parameter | Symbol | Test Conditions | Min | Typ | Max | Units | |
|-------------------------------|------------|---|------------------------|------|--------|------------------|----|
| Input Voltage | V_{IN} | — | Note 1 | — | 5.5 | V | |
| Output Voltage | V_O | $I_O = 1\text{mA}$ | -2 | — | +2 | % | |
| Output Current | I_O | — | 300 | — | Note 2 | mA | |
| Dropout Voltage | V_{DROP} | $I_O = 300\text{mA}$ | $V_O = 1.5V$ | — | 1150 | 1400 | mV |
| | | | $V_O = 1.8V$ | — | 850 | 1100 | |
| | | | $2.5V \leq V_O < 3.3V$ | — | 370 | 450 | |
| | | | $V_O \geq 3.3V$ | — | 180 | 230 | |
| Ground Current | I_{GND} | $I_O = 1\text{mA}$ to 300mA | — | 70 | 90 | μA | |
| Quiescent Current | I_Q | $I_O = 0\text{mA}$ | — | 65 | 90 | μA | |
| Line Regulation | LNR | $I_O = 1\text{mA}$, $V_O < 2V$, $V_{IN} = 2.8V$ to $3.8V$ | -0.15 | 0.10 | 0.15 | %V | |
| | | $I_O = 1\text{mA}$, $2V \leq V_O < 3.3V$, $V_{IN} = V_O + 0.5V$ to $V_O + 1V$ | -0.10 | 0.03 | 0.10 | | |
| | | $I_O = 1\text{mA}$, $V_O \geq 3.3V$, $V_{IN} = V_O + 0.5V$ to $V_O + 1V$ | -0.4 | 0.2 | 0.4 | | |
| Load Regulation | LDR | $I_O = 1\text{mA}$ to 300mA , $V_O \geq 2V$ | -2 | 1 | +2 | % | |
| | | $I_O = 1\text{mA}$ to 300mA , $V_O < 2V$ | — | 30 | 60 | mV | |
| Temperature Coefficient | T_C | $I_O = 1\text{mA}$ | — | 40 | — | ppm/°C | |
| Over Temperature Shutdown | OTS | $I_O = 1\text{mA}$ | — | 150 | — | °C | |
| Over Temperature Hysteresis | OTH | $I_O = 1\text{mA}$ | — | 30 | — | °C | |
| Power Supply Ripple Rejection | PSRR | $I_O = 100\text{mA}$ $C_{BYP} = 10\text{nF}$ $V_O = 3.3V$ | $f = 100\text{Hz}$ | — | 70 | — | dB |
| | | | $f = 1\text{kHz}$ | — | 65 | — | |
| Output Noise | V_N | $f = 10\text{Hz}$ to 100kHz , $C_{BYP} = 10\text{nF}$ | — | 50 | — | μVRMS | |
| CE Input High Threshold | V_{TH} | $V_{IN} = 2.5V$ to $5V$ | 1.5 | — | — | V | |
| CE Input Low Threshold | V_{TL} | $V_{IN} = 2.5V$ to $5V$ | — | — | 0.3 | V | |
| Shutdown Current | I_{SD} | $V_{EN} = 0V$ | — | 0.01 | 1 | μA | |

Notes: 1. The minimum input voltage ($V_{IN(MIN)}$) of the PAM3101 is determined by output voltage and dropout voltage. The minimum input voltage is defined as:
 $V_{IN(MIN)} = V_O + V_{DROP}$
 2. Output current is limited by P_D , maximum $I_O = P_D / (V_{IN(MAX)} - V_O)$.

Typical Performance Characteristics

(@T_A = +25°C, V_{EN} = V_{IN}, C_{IN} = 1μF, C_O = 2.2μF, C_{BYP} = 10nF unless otherwise specified.)

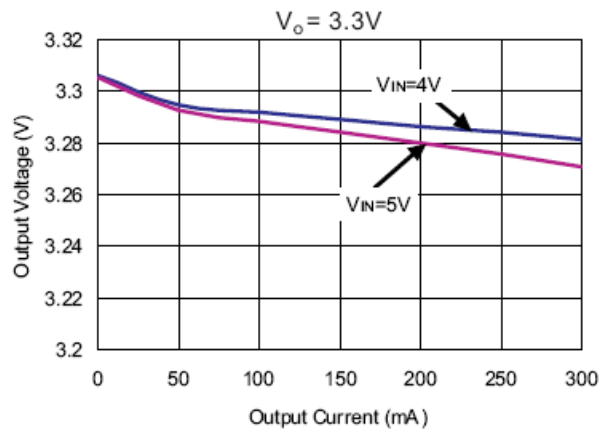
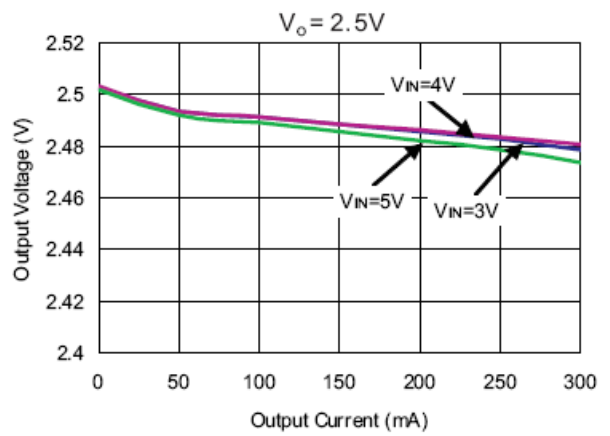
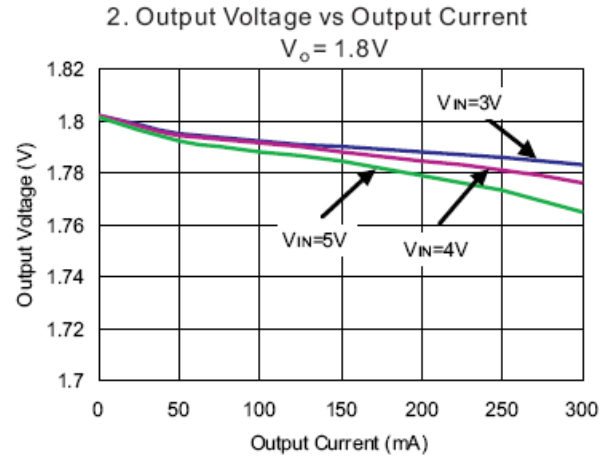

Typical Performance Characteristics (cont.)

(@ $T_A = +25^\circ\text{C}$, $V_{EN} = V_{IN}$, $C_{IN} = 1\mu\text{F}$, $C_O = 2.2\mu\text{F}$, $C_{BYP} = 10\text{nF}$ unless otherwise specified.)

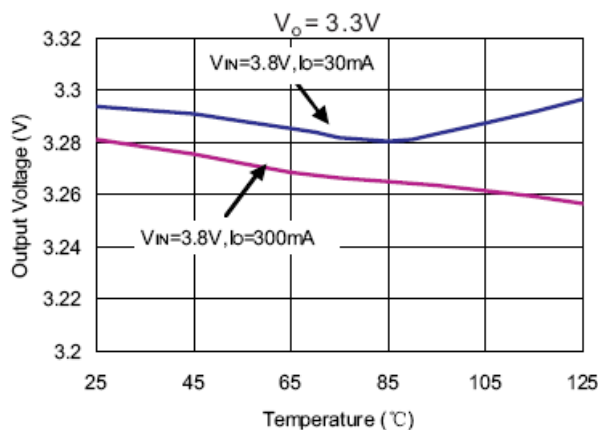
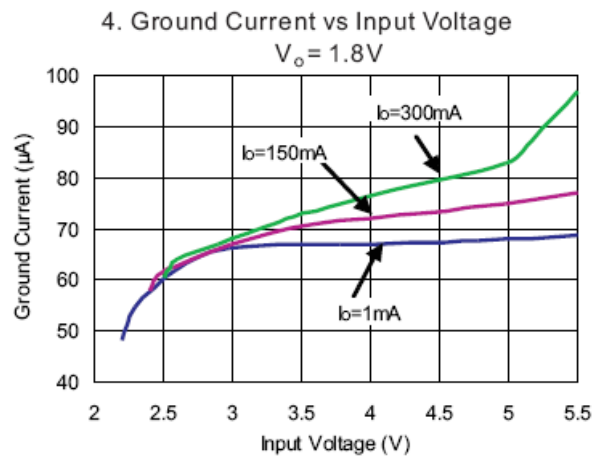

Typical Performance Characteristics (cont.)

(@T_A = +25°C, V_{EN} = V_{IN}, C_{IN} = 1μF, C_O = 2.2μF, C_{BYP} = 10nF unless otherwise specified.)

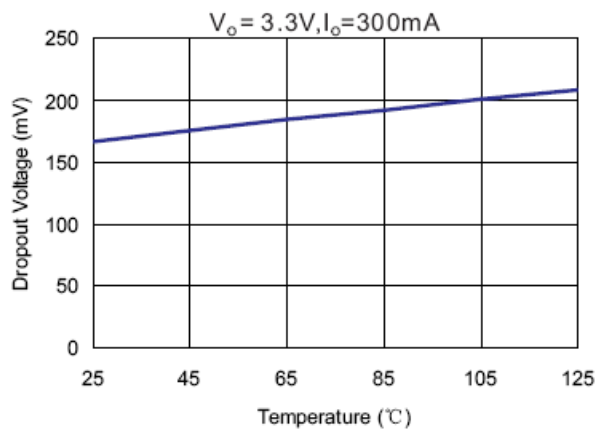
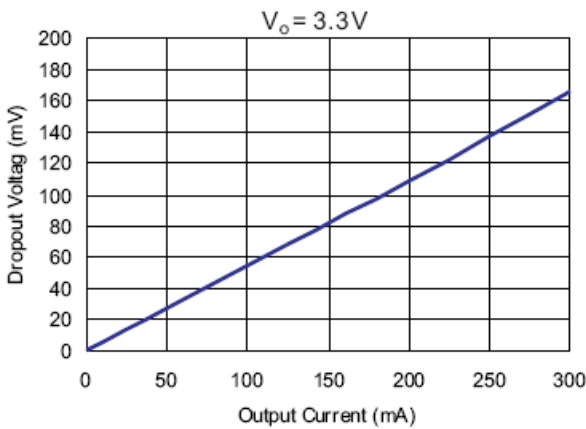

Typical Performance Characteristics (cont.)

(@T_A = +25°C, V_{EN} = V_{IN}, C_{IN} = 1μF, C_O = 2.2μF, C_{BYP} = 10nF unless otherwise specified.)

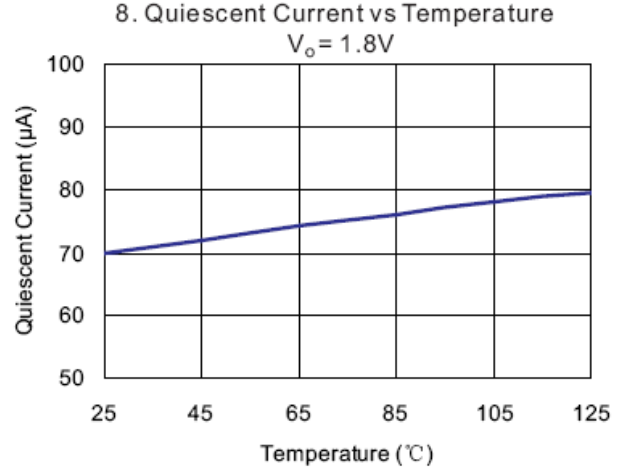
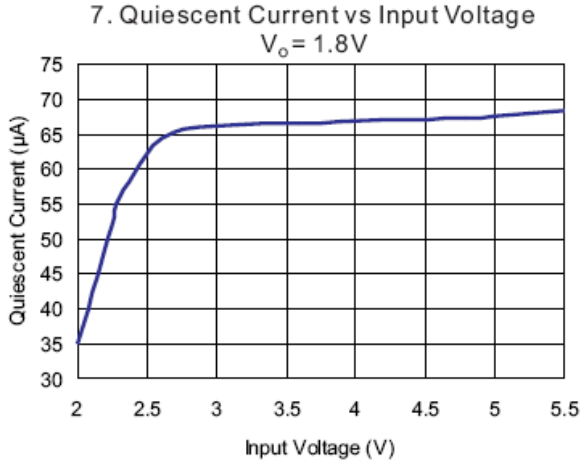

Typical Performance Characteristics (cont.)

(@T_A = +25°C, V_{EN} = V_{IN}, C_{IN} = 1μF, C_O = 2.2μF, C_{BYP} = 10nF unless otherwise specified.)

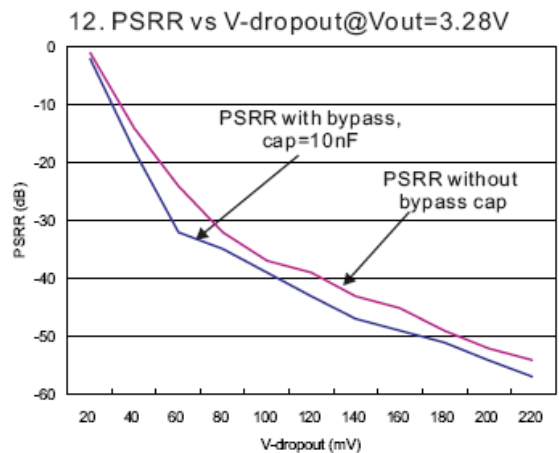
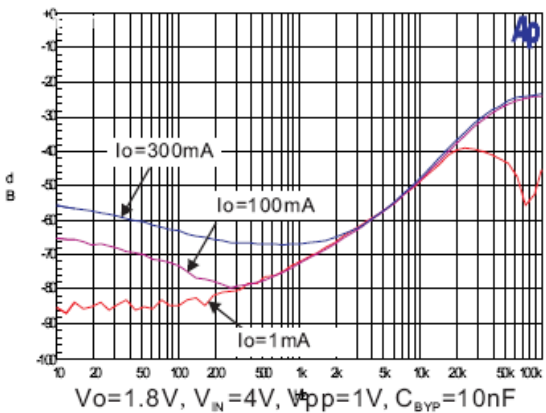
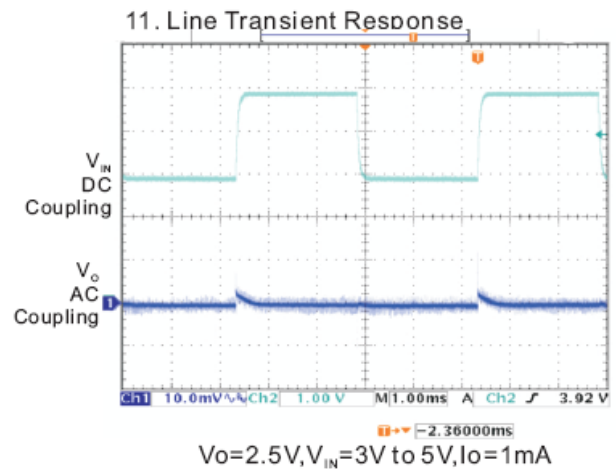
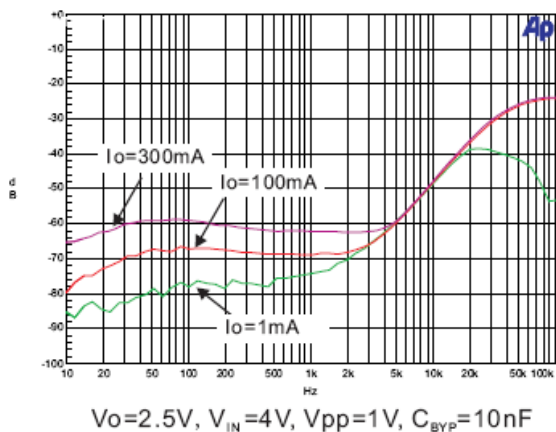
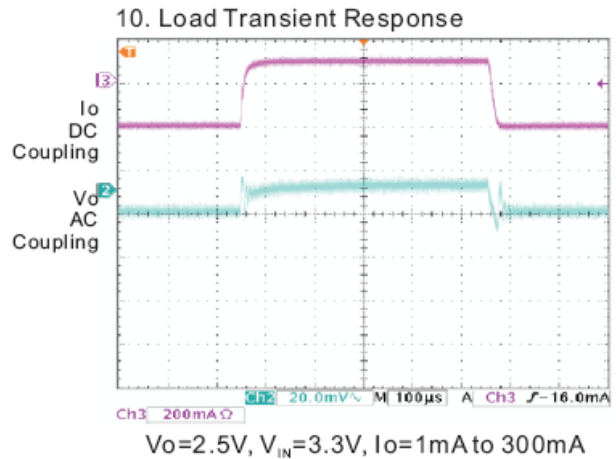
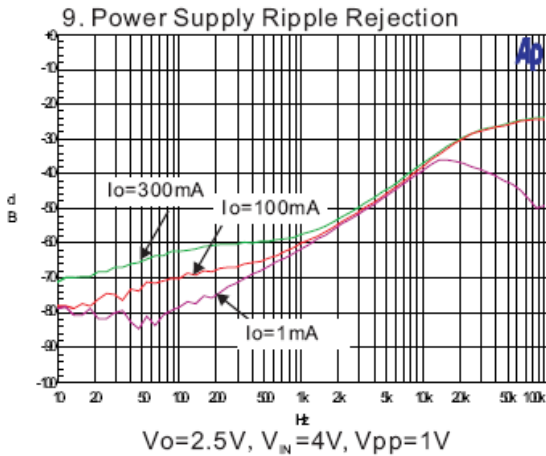

Typical Performance Characteristics (cont.)

(@T_A = +25°C, V_{EN} = V_{IN}, C_{IN} = 1μF, C_O = 2.2μF, C_{BYP} = 10nF unless otherwise specified.)

13. Turn-on Response

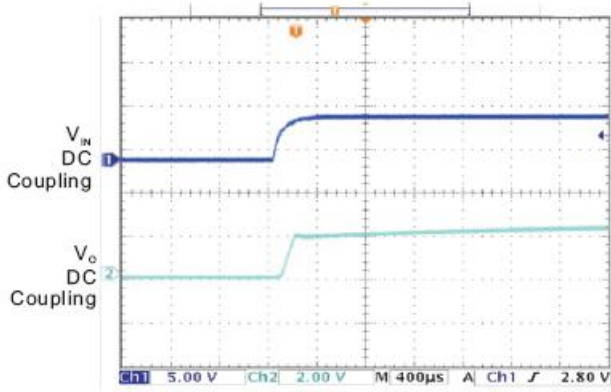

Application Information

Capacitor Selection and Regulator Stability

Similar to any low dropout regulator, the external capacitors used with the PAM3101 must be carefully selected for regulator stability and performance.

A capacitor C_{IN} of more than $1\mu\text{F}$ can be employed in the input pin, while there is no upper limit for the capacitance of C_{IN} . Please note that the distance between C_{IN} and the input pin of the PAM3101 should not exceed 0.5 inch. Ceramic capacitors are suitable for the PAM3101. Capacitors with larger values and lower ESR (equivalent series resistance) provide better PSRR and line-transient response.

The PAM3101 is designed specifically to work with low ESR ceramic output capacitors in order to save space and improve performance. Using an output ceramic capacitor whose value is $>2.2\mu\text{F}$ with $\text{ESR} > 5\text{m}\Omega$ ensures stability.

A 10nF bypass capacitor connected to BYP pin is suggested for suppressing output noise. The capacitor, in series connection with an internal 200k Ω resistor, forms a low-pass filter for noise reduction. Increasing the capacitance will slightly decrease the output noise, but increase the start-up time.

Load Transient Consideration

Curve 10 of the PAM3101 load-transient response on page 10 shows two components of the output response; a DC shift from the output impedance due to the load current change and transient response. The DC shift is quite small due to excellent load regulation of the PAM3101. The transient spike, resulting from a step change in the load current from 1mA to 300mA, is 20mV. The ESR of the output capacitor is critical to the transient spike. A larger capacitance with smaller ESR results in a smaller spike.

Shutdown Input Operation

The PAM3101 is shut down by pulling the EN input low, and is turned on by tying the EN input to V_{IN} .

Internal P-Channel Pass Transistor

The PAM3101 features a 0.75 Ω P-Channel MOSFET device as a pass transistor. The PMOS pass transistor enables the PAM3101 to consume only 65 μA of ground current during low dropout, light-load, or heavy-load operations. This feature increases the battery operation life time.

Input-Output (Dropout) Voltage

A regulator's minimum input-output voltage difference (or dropout voltage) determines the lowest usable supply voltage. The PAM3101 has a typical 300mV dropout voltage. In battery powered systems, this will determine the useful end-of-life battery voltage.

Current Limit and Short Circuit Protection

The PAM3101 features a current limit, which monitors and controls the gate voltage of the pass transistor. The output current can be limited to 400mA by regulating the gate voltage. The PAM3101 also has a built-in short circuit current limit.

Thermal Considerations

Thermal protection limits power dissipation in the PAM3101. When the junction temperature exceeds $+150^{\circ}\text{C}$, the OTP (Over Temperature Protection) starts the thermal shutdown and turns the pass transistor off. The pass transistor resumes operation after the junction temperature drops below $+120^{\circ}\text{C}$.

For continuous operation, the junction temperature should be maintained below $+125^{\circ}\text{C}$. The power dissipation is defined as:

$$P_D = (V_{IN} - V_{OUT}) \cdot I_O + V_{IN} \cdot I_{GND}$$

The maximum power dissipation depends on the thermal resistance of IC package, PCB layout, the rate of surrounding airflow and temperature difference between junction and ambient. The maximum power dissipation can be calculated by the following formula:

$$P_{D(MAX)} = (T_{J(MAX)} - T_A) / \theta_{JA}$$

Where $T_{J(MAX)}$ is the maximum allowable junction temperature $+125^{\circ}\text{C}$, T_A is the ambient temperature and θ_{JA} is the thermal resistance from the junction to the ambient.

Application Information (cont.)

For example, as θ_{JA} is 250°C/W for the SOT-23 package and 180°C/W for the SOT-89 package based on the standard JEDEC 51-3 for a single-layer thermal test board, the maximum power dissipation at $T_A + 25^\circ\text{C}$ can be calculated by following formula:

$$P_{D(\text{MAX})} = (125^\circ\text{C} - 25^\circ\text{C}) / 250 = 0.4\text{W SOT-23}$$

$$P_{D(\text{MAX})} = (125^\circ\text{C} - 25^\circ\text{C}) / 180 = 0.55\text{W SOT-89}$$

It is also useful to calculate the junction temperature of the PAM3101 under a set of specific conditions. Suppose the input voltage $V_{IN} = 3.3\text{V}$, the output current $I_O = 300\text{mA}$ and the case temperature $T_A = +40^\circ\text{C}$ measured by a thermocouple during operation, the power dissipation for the $V_O = 2.8\text{V}$ version of the PAM3101 can be calculated as:

$$P_D = (3.3\text{V} - 2.8\text{V}) * 300\text{mA} + 3.3\text{V} * 70\mu\text{A} \cong 150\text{mW}$$

And the junction temperature, T_J can be calculated as follows:

$$T_J = T_A + P_D * \theta_{JA}$$

$$T_J = 40^\circ\text{C} + 0.15\text{W} * 250^\circ\text{C/W}$$

$$= 40^\circ\text{C} + 37.5^\circ\text{C}$$

$$= 77.5^\circ\text{C} < T_{J(\text{MAX})} = +125^\circ\text{C}$$

For this application, T_J is lower than the absolute maximum operating junction temperature, $+125^\circ\text{C}$, so it is safe to use the PAM3101 in this configuration.

NOT RECOMMENDED
FOR NEW DESIGN

Ordering Information



| Pin Configuration | | Package Type | Number of Pins | Output Voltage |
|---|--|---|------------------------------|---|
| A Type: 1. GND 2. VOUT 3. VIN | E Type: 1. VOUT 2. GND 3. NC 4. EN (EN Default floating) 5. VIN | A: SOT23 C: SOT-89 U: SC70 K: DFN1.6x1.6 | A: 3 K: 4 B: 5 F: 6 | 475: 4.75V 400: 4.0V 380: 3.8V 330: 3.3 V 310: 3.1V 290: 2.9V 285: 2.85V 280: 2.8V 250: 2.5V 200: 2.0V 180: 1.8V 150: 1.5V |
| B Type: 1. VIN 2. GND 3. EN (EN Default floating) 4. NC 5. VOUT | F Type: 1. EN (EN Default floating) 2. NC 3. VIN 4. VOUT 5. NC 6. GND | | | |
| C Type: 1. VOUT 2. GND 3. VIN | G Type: 1. VIN 2. VOUT 3. GND | | | |
| D Type: 1. VIN 2. GND 3. EN (EN Default pull high) 4. BYP 5. VOUT | H Type: 1. GND 2. VIN 3. VOUT | | | |

NOT RECOMMENDED FOR NEW DESIGN

Ordering Information (cont.)

| Part Number | Output Voltage | Marking | Package Type | Shipping Package |
|---------------|----------------|---------|--------------|----------------------|
| PAM3101AAA475 | 4.75V | AATYW | SOT23-3 | 3,000Units/Tape&Reel |
| PAM3101AAA400 | 4.0V | AAMYW | SOT23-3 | 3,000Units/Tape&Reel |
| PAM3101AAA380 | 3.8V | AAOYW | SOT23-3 | 3,000Units/Tape&Reel |
| PAM3101AAA330 | 3.3V | AAKYW | SOT23-3 | 3,000Units/Tape&Reel |
| PAM3101AAA310 | 3.1V | AAPYW | SOT23-3 | 3,000Units/Tape&Reel |
| PAM3101AAA300 | 3.0V | AAJYW | SOT23-3 | 3,000Units/Tape&Reel |
| PAM3101AAA290 | 2.9V | AAQYW | SOT23-3 | 3,000Units/Tape&Reel |
| PAM3101AAA285 | 2.85V | AAIYW | SOT23-3 | 3,000Units/Tape&Reel |
| PAM3101AAA280 | 2.8V | AAHYW | SOT23-3 | 3,000Units/Tape&Reel |
| PAM3101AAA250 | 2.5V | AAGYW | SOT23-3 | 3,000Units/Tape&Reel |
| PAM3101AAA180 | 1.8V | AAEYW | SOT23-3 | 3,000Units/Tape&Reel |
| PAM3101AAA150 | 1.5V | AACYW | SOT23-3 | 3,000Units/Tape&Reel |
| PAM3101GAA475 | 4.75V | AATYW | SOT23-3 | 3,000Units/Tape&Reel |
| PAM3101GAA400 | 4.0V | AAMYW | SOT23-3 | 3,000Units/Tape&Reel |
| PAM3101GAA380 | 3.8V | AAOYW | SOT23-3 | 3,000Units/Tape&Reel |
| PAM3101GAA330 | 3.3V | AAKYW | SOT23-3 | 3,000Units/Tape&Reel |
| PAM3101GAA310 | 3.1V | AAPYW | SOT23-3 | 3,000Units/Tape&Reel |
| PAM3101GAA300 | 3.0V | AAJYW | SOT23-3 | 3,000Units/Tape&Reel |
| PAM3101GAA290 | 2.9V | AAQYW | SOT23-3 | 3,000Units/Tape&Reel |
| PAM3101GAA285 | 2.85V | AAIYW | SOT23-3 | 3,000Units/Tape&Reel |
| PAM3101GAA280 | 2.8V | AAHYW | SOT23-3 | 3,000Units/Tape&Reel |
| PAM3101GAA250 | 2.5V | AAGYW | SOT23-3 | 3,000Units/Tape&Reel |
| PAM3101GAA180 | 1.8V | AAEYW | SOT23-3 | 3,000Units/Tape&Reel |
| PAM3101GAA150 | 1.5V | AACYW | SOT23-3 | 3,000Units/Tape&Reel |
| PAM3101CAA475 | 4.75V | AATYW | SOT23-3 | 3,000Units/Tape&Reel |
| PAM3101CAA400 | 4.0V | AAMYW | SOT23-3 | 3,000Units/Tape&Reel |
| PAM3101CAA380 | 3.8V | AAOYW | SOT23-3 | 3,000Units/Tape&Reel |
| PAM3101CAA330 | 3.3V | AAKYW | SOT23-3 | 3,000Units/Tape&Reel |
| PAM3101CAA310 | 3.1V | AAPYW | SOT23-3 | 3,000Units/Tape&Reel |
| PAM3101CAA300 | 3.0V | AAJYW | SOT23-3 | 3,000Units/Tape&Reel |
| PAM3101CAA290 | 2.9V | AAQYW | SOT23-3 | 3,000Units/Tape&Reel |
| PAM3101CAA285 | 2.85V | AAIYW | SOT23-3 | 3,000Units/Tape&Reel |
| PAM3101CAA280 | 2.8V | AAHYW | SOT23-3 | 3,000Units/Tape&Reel |
| PAM3101CAA250 | 2.5V | AAGYW | SOT23-3 | 3,000Units/Tape&Reel |
| PAM3101CAA180 | 1.8V | AAEYW | SOT23-3 | 3,000Units/Tape&Reel |
| PAM3101CAA150 | 1.5V | AACYW | SOT23-3 | 3,000Units/Tape&Reel |

Ordering Information (cont.)

| Part Number | Output Voltage | Marking | Package Type | Shipping Package |
|---------------|----------------|-----------------|--------------|----------------------|
| PAM3101CCA475 | 4.75V | P3101T XXXYW | SOT89-3 | 1,000Units/Tape&Reel |
| PAM3101CCA400 | 4.0V | P3101M XXXYW | SOT89-3 | 1,000Units/Tape&Reel |
| PAM3101CCA380 | 3.8V | P3101O XXXYW | SOT89-3 | 1,000Units/Tape&Reel |
| PAM3101CCA330 | 3.3V | P3101K XXXYW | SOT89-3 | 1,000Units/Tape&Reel |
| PAM3101CCA310 | 3.1V | P3101P XXXYW | SOT89-3 | 1,000Units/Tape&Reel |
| PAM3101CCA300 | 3.0V | P3101J XXXYW | SOT89-3 | 1,000Units/Tape&Reel |
| PAM3101CCA290 | 2.9V | P3101Q XXXYW | SOT89-3 | 1,000Units/Tape&Reel |
| PAM3101CCA285 | 2.85V | P3101I XXXYW | SOT89-3 | 1,000Units/Tape&Reel |
| PAM3101CCA280 | 2.8V | P3101H XXXYW | SOT89-3 | 1,000Units/Tape&Reel |
| PAM3101CCA250 | 2.5V | P3101G XXXYW | SOT89-3 | 1,000Units/Tape&Reel |
| PAM3101CCA180 | 1.8V | P3101E XXXYW | SOT89-3 | 1,000Units/Tape&Reel |
| PAM3101CCA150 | 1.5V | P3101C XXXYW | SOT89-3 | 1,000Units/Tape&Reel |
| PAM3101HCA475 | 4.75V | P3101T XXXYW | SOT89-3 | 1,000Units/Tape&Reel |
| PAM3101HCA400 | 4.0V | P3101M XXXYW | SOT89-3 | 1,000Units/Tape&Reel |
| PAM3101HCA380 | 3.8V | P3101O XXXYW | SOT89-3 | 1,000Units/Tape&Reel |
| PAM3101HCA330 | 3.3V | P3101K XXXYW | SOT89-3 | 1,000Units/Tape&Reel |
| PAM3101HCA310 | 3.1V | P3101P XXXYW | SOT89-3 | 1,000Units/Tape&Reel |
| PAM3101HCA300 | 3.0V | P3101J XXXYW | SOT89-3 | 1,000Units/Tape&Reel |
| PAM3101HCA290 | 2.90V | P3101Q XXXYW | SOT89-3 | 1,000Units/Tape&Reel |
| PAM3101HCA285 | 2.85V | P3101I XXXYW | SOT89-3 | 1,000Units/Tape&Reel |
| PAM3101HCA280 | 2.8V | P3101H XXXYW | SOT89-3 | 1,000Units/Tape&Reel |

Ordering Information (cont.)

| Part Number | Output Voltage | Marking | Package Type | Shipping Package |
|---------------|----------------|-----------------|--------------|----------------------|
| PAM3101HCA250 | 2.5V | P3101G XXXYW | SOT89-3 | 1,000Units/Tape&Reel |
| PAM3101HCA180 | 1.8V | P3101E XXXYW | SOT89-3 | 1,000Units/Tape&Reel |
| PAM3101HCA150 | 1.5V | P3101C XXXYW | SOT89-3 | 1,000Units/Tape&Reel |
| PAM3101DAB475 | 4.75V | AATYW | SOT23-5 | 3,000Units/Tape&Reel |
| PAM3101DAB400 | 4.0V | AAMYW | SOT23-5 | 3,000Units/Tape&Reel |
| PAM3101DAB380 | 3.8V | AAOYW | SOT23-5 | 3,000Units/Tape&Reel |
| PAM3101DAB330 | 3.3V | AAKYW | SOT23-5 | 3,000Units/Tape&Reel |
| PAM3101DAB310 | 3.1V | AAPYW | SOT23-5 | 3,000Units/Tape&Reel |
| PAM3101DAB300 | 3.0V | AAJYW | SOT23-5 | 3,000Units/Tape&Reel |
| PAM3101DAB290 | 2.9V | AAQYW | SOT23-5 | 3,000Units/Tape&Reel |
| PAM3101DAB285 | 2.85V | AAIYW | SOT23-5 | 3,000Units/Tape&Reel |
| PAM3101DAB280 | 2.8V | AAHYW | SOT23-5 | 3,000Units/Tape&Reel |
| PAM3101DAB250 | 2.5V | AAGYW | SOT23-5 | 3,000Units/Tape&Reel |
| PAM3101DAB180 | 1.8V | AAEYW | SOT23-5 | 3,000Units/Tape&Reel |
| PAM3101DAB150 | 1.5V | AACYW | SOT23-5 | 3,000Units/Tape&Reel |
| PAM3101ECB475 | 4.75V | P3101T XXXYW | SOT89-5 | 1,000Units/Tape&Reel |
| PAM3101ECB400 | 4.0V | P3101M XXXYW | SOT89-5 | 1,000Units/Tape&Reel |
| PAM3101ECB380 | 3.8V | P3101O XXXYW | SOT89-5 | 1,000Units/Tape&Reel |
| PAM3101ECB330 | 3.3V | P3101K XXXYW | SOT89-5 | 1,000Units/Tape&Reel |
| PAM3101ECB310 | 3.1V | P3101P XXXYW | SOT89-5 | 1,000Units/Tape&Reel |
| PAM3101ECB300 | 3.0V | P3101J XXXYW | SOT89-5 | 1,000Units/Tape&Reel |
| PAM3101ECB290 | 2.9V | P3101Q XXXYW | SOT89-5 | 1,000Units/Tape&Reel |
| PAM3101ECB285 | 2.85V | P3101I XXXYW | SOT89-5 | 1,000Units/Tape&Reel |
| PAM3101ECB280 | 2.8V | P3101H XXXYW | SOT89-5 | 1,000Units/Tape&Reel |
| PAM3101ECB250 | 2.5V | P3101G XXXYW | SOT89-5 | 1,000Units/Tape&Reel |
| PAM3101ECB180 | 1.8V | P3101E XXXYW | SOT89-5 | 1,000Units/Tape&Reel |
| PAM3101ECB150 | 1.5V | P3101C XXXYW | SOT89-5 | 1,000Units/Tape&Reel |

Ordering Information (cont.)

| Part Number | Output Voltage | Marking | Package Type | Shipping Package |
|---------------|----------------|---------|--------------|----------------------|
| PAM3101GUA475 | 4.75V | AATYW | SC70-3L | 3,000Units/Tape&Reel |
| PAM3101GUA400 | 4.0V | AAMYW | SC70-3L | 3,000Units/Tape&Reel |
| PAM3101GUA380 | 3.8V | AAOYW | SC70-3L | 3,000Units/Tape&Reel |
| PAM3101GUA330 | 3.3V | AAKYW | SC70-3L | 3,000Units/Tape&Reel |
| PAM3101GUA310 | 3.1V | AAPYW | SC70-3L | 3,000Units/Tape&Reel |
| PAM3101GUA300 | 3.0V | AAJYW | SC70-3L | 3,000Units/Tape&Reel |
| PAM3101GUA290 | 2.9V | AAQYW | SC70-3L | 3,000Units/Tape&Reel |
| PAM3101GUA285 | 2.85V | AAIYW | SC70-3L | 3,000Units/Tape&Reel |
| PAM3101GUA280 | 2.8V | AAHYW | SC70-3L | 3,000Units/Tape&Reel |
| PAM3101GUA250 | 2.5V | AAGYW | SC70-3L | 3,000Units/Tape&Reel |
| PAM3101GUA180 | 1.8V | AAEYW | SC70-3L | 3,000Units/Tape&Reel |
| PAM3101GUA150 | 1.5V | AACYW | SC70-3L | 3,000Units/Tape&Reel |
| PAM3101DUB475 | 4.75V | AATYW | SC70-5L | 3,000Units/Tape&Reel |
| PAM3101DUB400 | 4.0V | AAMYW | SC70-5L | 3,000Units/Tape&Reel |
| PAM3101DUB380 | 3.8V | AAOYW | SC70-5L | 3,000Units/Tape&Reel |
| PAM3101DUB330 | 3.3V | AAKYW | SC70-5L | 3,000Units/Tape&Reel |
| PAM3101DUB310 | 3.1V | AAPYW | SC70-5L | 3,000Units/Tape&Reel |
| PAM3101DUB300 | 3.0V | AAJYW | SC70-5L | 3,000Units/Tape&Reel |
| PAM3101DUB290 | 2.9V | AAQYW | SC70-5L | 3,000Units/Tape&Reel |
| PAM3101DUB285 | 2.85V | AAIYW | SC70-5L | 3,000Units/Tape&Reel |
| PAM3101DUB280 | 2.8V | AAHYW | SC70-5L | 3,000Units/Tape&Reel |
| PAM3101DUB250 | 2.5V | AAGYW | SC70-5L | 3,000Units/Tape&Reel |
| PAM3101DUB180 | 1.8V | AAEYW | SC70-5L | 3,000Units/Tape&Reel |
| PAM3101DUB150 | 1.5V | AACYW | SC70-5L | 3,000Units/Tape&Reel |

NO FOR

Marking Information

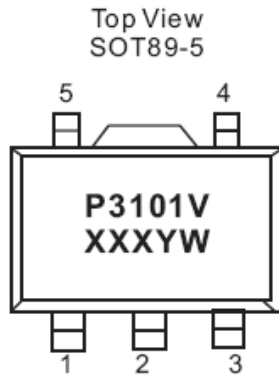
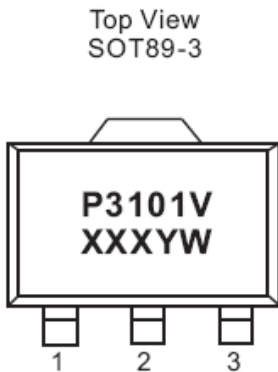

AA: Product Code of PAM3101
V: Voltage Code
X: Internal Code
Y: Year
W: Week

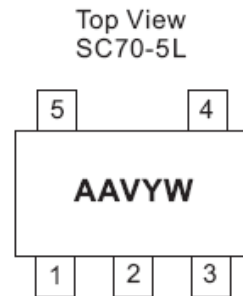
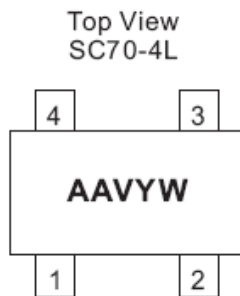
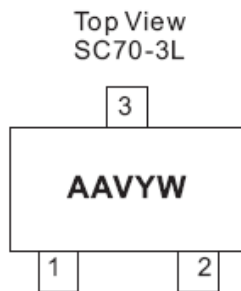

NOT RECOMMENDED

Package Outline Dimensions (All dimensions in mm.)

SOT23-3



| Dim | Millimeters | | |
|-----|-------------|-------|------|
| | Min. | Typ. | Max. |
| A | 1.00 | 1.15 | 1.30 |
| A1 | 0.00 | 0.05 | 0.10 |
| B | 0.35 | 0.43 | 0.51 |
| C | 0.10 | 0.175 | 0.25 |
| D | 2.70 | 2.90 | 3.10 |
| E | 1.40 | 1.60 | 1.80 |
| e | 1.90BSC | | |
| H | 2.40 | 2.70 | 3.00 |
| L | 0.37 | | |



NOT REC
FOR NEW

Package Outline Dimensions (cont.) (All dimensions in mm.)

SOT23-5



| REF. | Millimeter | |
|------|------------|------|
| | Min | Max |
| A | 1.10MAX | |
| A1 | 0 | 0.10 |
| A2 | 0.70 | 1 |
| c | 0.12REF. | |
| D | 2.70 | 3.10 |
| E | 2.60 | 3.00 |
| E1 | 1.40 | 1.80 |
| L | 0.45REF. | |
| L1 | 0.60REF. | |
| θ | 0° | 10° |
| b | 0.30 | 0.50 |
| e | 0.95REF. | |
| e1 | 1.90REF. | |

Package Outline Dimensions (cont.) (All dimensions in mm.)

SC70-3L



| REF. | Millimeter | | REF. | Millimeter | |
|------|------------|------|------|------------|------|
| | Min. | Max. | | Min. | Max. |
| A | 0.80 | 1.10 | L1 | 0.42 REF. | |
| A1 | 0 | 0.10 | L | 0.15 | 0.35 |
| A2 | 0.80 | 1.00 | b | 0.25 | 0.40 |
| D | 1.80 | 2.20 | c | 0.10 | 0.25 |
| E | 1.15 | 1.35 | e | | |
| HE | 1.80 | 2.40 | | | |

M
K

Package Outline Dimensions (All dimensions in mm.)

SC70-4L



| SYMBOL | MIN | MAX |
|--------|-------|-------|
| e | 0.65 | BSC |
| e1 | 0.50 | BSC |
| D | 1.80 | 2.20 |
| b | 0.15 | 0.30 |
| b1 | 0.575 | 0.700 |
| E | 1.15 | 1.35 |
| HE | 1.80 | 2.40 |
| Q1 | 0.10 | 0.40 |
| A2 | 0.80 | 1.00 |
| A1 | 0.00 | 0.10 |
| A | 0.80 | 1.10 |
| c | 0.10 | 0.18 |
| L | 0.10 | 0.30 |
| Lj | 0.26 | 0.46 |

- 1) ALL DIMENSIONS ARE IN MILLIMETERS
- 2) DIMENSIONS ARE INCLUSIVE OF PLATING
- 3) DIMENSIONS ARE EXCLUSIVE OF MOLD FLASH & METAL BURR
- 4) CUSTOM LEADCOUNT VARIATION OF JEITA SC70

Package Outline Dimensions (All dimensions in mm.)

DFN 1.6x1.6-6L

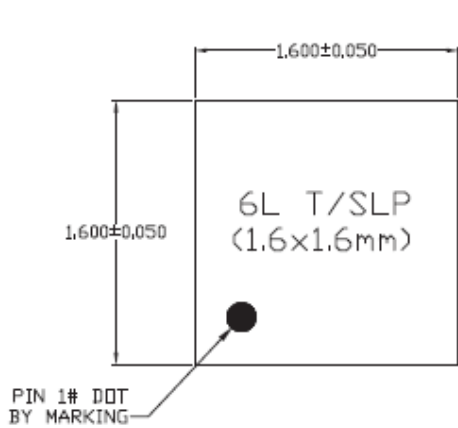

TOP VIEW

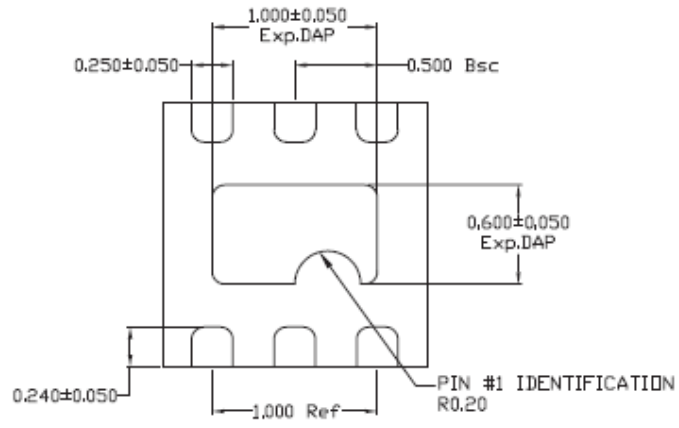

BOTTOM VIEW

| | | |
|---|------|-------|
| A | MAX. | 0.800 |
| | NDM. | 0.750 |
| | MIN. | 0.700 |

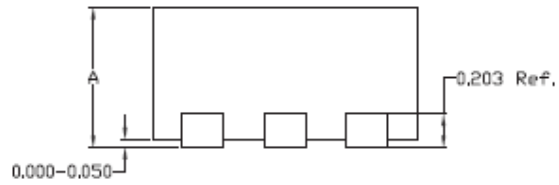

SIDE VIEW

Note: All dimensions are in Millimeters.

NOT RECOMMENDED FOR NEW DESIGN

IMPORTANT NOTICE

DIODES INCORPORATED MAKES NO WARRANTY OF ANY KIND, EXPRESS OR IMPLIED, WITH REGARDS TO THIS DOCUMENT, INCLUDING, BUT NOT LIMITED TO, THE IMPLIED WARRANTIES OF MERCHANTABILITY AND FITNESS FOR A PARTICULAR PURPOSE (AND THEIR EQUIVALENTS UNDER THE LAWS OF ANY JURISDICTION).

Diodes Incorporated and its subsidiaries reserve the right to make modifications, enhancements, improvements, corrections or other changes without further notice to this document and any product described herein. Diodes Incorporated does not assume any liability arising out of the application or use of this document or any product described herein; neither does Diodes Incorporated convey any license under its patent or trademark rights, nor the rights of others. Any Customer or user of this document or products described herein in such applications shall assume all risks of such use and will agree to hold Diodes Incorporated and all the companies whose products are represented on Diodes Incorporated website, harmless against all damages.

Diodes Incorporated does not warrant or accept any liability whatsoever in respect of any products purchased through unauthorized sales channel. Should Customers purchase or use Diodes Incorporated products for any unintended or unauthorized application, Customers shall indemnify and hold Diodes Incorporated and its representatives harmless against all claims, damages, expenses, and attorney fees arising out of, directly or indirectly, any claim of personal injury or death associated with such unintended or unauthorized application.

Products described herein may be covered by one or more United States, international or foreign patents pending. Product names and markings noted herein may also be covered by one or more United States, international or foreign trademarks.

This document is written in English but may be translated into multiple languages for reference. Only the English version of this document is the final and determinative format released by Diodes Incorporated.

LIFE SUPPORT

Diodes Incorporated products are specifically not authorized for use as critical components in life support devices or systems without the express written approval of the Chief Executive Officer of Diodes Incorporated. As used herein:

A. Life support devices or systems are devices or systems which:

1. are intended to implant into the body, or
2. support or sustain life and whose failure to perform when properly used in accordance with instructions for use provided in the labeling can be reasonably expected to result in significant injury to the user.

B. A critical component is any component in a life support device or system whose failure to perform can be reasonably expected to cause the failure of the life support device or to affect its safety or effectiveness.

Customers represent that they have all necessary expertise in the safety and regulatory ramifications of their life support devices or systems, and acknowledge and agree that they are solely responsible for all legal, regulatory and safety-related requirements concerning their products and any use of Diodes Incorporated products in such safety-critical, life support devices or systems, notwithstanding any devices- or systems-related information or support that may be provided by Diodes Incorporated. Further, Customers must fully indemnify Diodes Incorporated and its representatives against any damages arising out of the use of Diodes Incorporated products in such safety-critical, life support devices or systems.

Copyright © 2016, Diodes Incorporated

www.diodes.com

Looking for pricing, stock, or lifecycle information?

Click below to explore more details on WIN SOURCE:

- ⊖ [View PAM3101HCA180 on WIN SOURCE](#)
- ⊖ [Diodes Incorporated Information](#)

Optimize Your Supply Chain with WIN SOURCE Solutions

- ✓ Global Sourcing Solution
- ✓ Obsolete Management
- ✓ Cost Control Management
- ✓ Shortage Management
- ✓ Alternative Solution
- ✓ Excess Inventory Management