



**THE DATASHEET OF
PBL51504V,115**



Important notice

Dear Customer,

On 7 February 2017 the former NXP Standard Product business became a new company with the tradename **Nexperia**. Nexperia is an industry leading supplier of Discrete, Logic and PowerMOS semiconductors with its focus on the automotive, industrial, computing, consumer and wearable application markets

In data sheets and application notes which still contain NXP or Philips Semiconductors references, use the references to Nexperia, as shown below.

Instead of <http://www.nxp.com>, <http://www.philips.com/> or <http://www.semiconductors.philips.com/>, use <http://www.nexperia.com>

Instead of sales.addresses@www.nxp.com or sales.addresses@www.semiconductors.philips.com, use salesaddresses@nexperia.com (email)

Replace the copyright notice at the bottom of each page or elsewhere in the document, depending on the version, as shown below:

- © NXP N.V. (year). All rights reserved or © Koninklijke Philips Electronics N.V. (year). All rights reserved

Should be replaced with:

- © **Nexperia B.V. (year). All rights reserved.**

If you have any questions related to the data sheet, please contact our nearest sales office via e-mail or telephone (details via salesaddresses@nexperia.com). Thank you for your cooperation and understanding,

Kind regards,

Team Nexperia

PBLS1504Y; PBLS1504V

15 V PNP BISS loadswitch

Rev. 03 — 25 August 2009

Product data sheet

1. Product profile

1.1 General description

Low V_{CEsat} PNP transistor and NPN resistor-equipped transistor in one package.

Table 1. Product overview

Type number	Package	
	NXP	JEITA
PBLS1504Y	SOT363	SC-88
PBLS1504V	SOT666	-

1.2 Features

- Low V_{CEsat} (BISS) and resistor-equipped transistor in one package
- Low 'threshold' voltage (< 1 V) compared to MOSFET
- Low drive power required
- Space-saving solution
- Reduction of component count

1.3 Applications

- Supply line switches
- Battery charger switches
- High-side switches for LEDs, drivers and backlights
- Portable equipment

1.4 Quick reference data

Table 2. Quick reference data

Symbol	Parameter	Conditions	Min	Typ	Max	Unit
TR1; PNP; low V_{CEsat} transistor						
V_{CEO}	collector-emitter voltage	open base	-	-	-15	V
I_C	collector current (DC)		-	-	-500	mA
R_{CEsat}	equivalent on-resistance	$I_C = -500$ mA; $I_B = -50$ mA	-	300	500	m Ω
TR2; NPN; resistor-equipped transistor						
V_{CEO}	collector-emitter voltage	open base	-	-	50	V

Table 2. Quick reference data ...continued

Symbol	Parameter	Conditions	Min	Typ	Max	Unit
I_o	output current (DC)		-	-	100	mA
R1	bias resistor 1 (input)		15.4	22	28.6	k Ω
R2/R1	bias resistor ratio		0.8	1	1.2	

2. Pinning information

Table 3. Discrete pinning

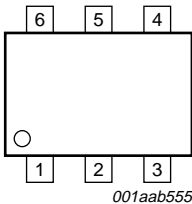
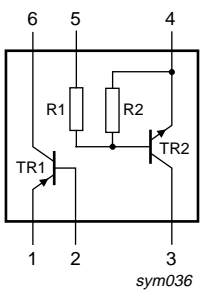
Pin	Description	Simplified outline	Symbol
1	emitter TR1	 <p>001aab555</p>	 <p>sym036</p>
2	base TR1		
3	output (collector) TR2		
4	GND (emitter) TR2		
5	input (base) TR2		
6	collector TR1		

3. Ordering information

Table 4. Ordering information

Type number	Package		Version
	Name	Description	
PBLS1504Y	SC-88	plastic surface mounted package; 6 leads	SOT363
PBLS1504V	-	plastic surface mounted package; 6 leads	SOT666

4. Marking

Table 5. Marking codes

Type number	Marking code ^[1]
PBLS1504Y	*C4
PBLS1504V	C4

[1] * = -: made in Hong Kong
 * = p: made in Hong Kong
 * = t: made in Malaysia
 * = W: made in China

5. Limiting values

Table 6. Limiting values

In accordance with the Absolute Maximum Rating System (IEC 60134).

Symbol	Parameter	Conditions	Min	Max	Unit
Transistor TR1: PNP					
V _{CBO}	collector-base voltage	open emitter	-	-15	V
V _{CEO}	collector-emitter voltage	open base	-	-15	V
V _{EBO}	emitter-base voltage	open collector	-	-6	V
I _C	collector current (DC)		-	-500	mA
I _{CM}	peak collector current	t _p ≤ 1 ms; δ ≤ 0.02	-	-1	A
I _B	base current (DC)		-	-50	mA
I _{BM}	peak base current	t _p ≤ 1 ms; δ ≤ 0.02	-	-100	mA
P _{tot}	total power dissipation	T _{amb} ≤ 25 °C	[1]	200	mW
Transistor TR2: NPN					
V _{CBO}	collector-base voltage	open emitter	-	50	V
V _{CEO}	collector-emitter voltage	open base	-	50	V
V _{EBO}	emitter-base voltage	open collector	-	10	V
V _I	input voltage		-		
	positive		-	+40	V
	negative		-	-10	V
I _O	output current (DC)		-	100	mA
I _{CM}	peak collector current		-	100	mA
P _{tot}	total power dissipation	T _{amb} ≤ 25 °C	[1]	200	mW
Per device					
P _{tot}	total power dissipation	T _{amb} ≤ 25 °C	-	300	mW
T _{stg}	storage temperature		-65	+150	°C
T _j	junction temperature		-	150	°C
T _{amb}	ambient temperature		-65	+150	°C

[1] Device mounted on a FR4 printed-circuit board, single-sided copper, tin-plated and standard footprint.

6. Thermal characteristics

Table 7. Thermal characteristics

Symbol	Parameter	Conditions	Min	Typ	Max	Unit
Per device						
R _{th(j-a)}	thermal resistance from junction to ambient	in free air				
			[1]	-	416	K/W
			[1][2]	-	416	K/W

[1] Device mounted on a FR4 printed-circuit board, single-sided copper, tin-plated and standard footprint.

[2] Reflow soldering is the only recommended soldering method.

7. Characteristics

Table 8. Characteristics
T_{amb} = 25 °C unless otherwise specified

Symbol	Parameter	Conditions	Min	Typ	Max	Unit
Transistor TR1: PNP						
I _{CBO}	collector-base cut-off current	V _{CB} = -15 V; I _E = 0 A	-	-	-100	nA
		V _{CB} = -15 V; I _E = 0 A; T _j = 150 °C	-	-	-50	μA
I _{CES}	collector-emitter cut-off current	V _{CE} = -15 V; V _{BE} = 0 V	-	-	-100	nA
I _{EBO}	emitter-base cut-off current	V _{EB} = -5 V; I _C = 0 A	-	-	-100	nA
h _{FE}	DC current gain	V _{CE} = -2 V; I _C = -10 mA	200	-	-	
		V _{CE} = -2 V; I _C = -100 mA	[1] 150	-	-	
		V _{CE} = -2 V; I _C = -500 mA	[1] 90	-	-	
V _{CEsat}	collector-emitter saturation voltage	I _C = -10 mA; I _B = -0.5 mA	-	-	-25	mV
		I _C = -200 mA; I _B = -10 mA	-	-	-150	mV
		I _C = -500 mA; I _B = -50 mA	[1] -	-	-250	mV
R _{CEsat}	equivalent on-resistance	I _C = -500 mA; I _B = -50 mA	[1] -	300	500	mΩ
V _{BEsat}	base-emitter saturation voltage	I _C = -500 mA; I _B = -50 mA	[1] -	-	-1.1	V
V _{BEon}	base-emitter turn-on voltage	V _{CE} = -2 V; I _C = -100 mA	[1] -	-	-0.9	V
f _T	transition frequency	V _{CE} = -5 V; I _C = -100 mA; f = 100 MHz	100	280	-	MHz
C _c	collector capacitance	V _{CB} = -10 V; I _E = I _e = 0 A; f = 1 MHz	-	-	10	pF
Transistor TR2: NPN						
I _{CBO}	collector-base cut-off current	V _{CB} = 50 V; I _E = 0 A	-	-	100	nA
I _{CEO}	collector-emitter cut-off current	V _{CE} = 30 V; I _B = 0 A	-	-	1	μA
		V _{CE} = 30 V; I _B = 0 A; T _j = 150 °C	-	-	50	μA
I _{EBO}	emitter-base cut-off current	V _{EB} = 5 V; I _C = 0 A	-	-	180	μA
h _{FE}	DC current gain	V _{CE} = 5 V; I _C = 5 mA	60	-	-	
V _{CEsat}	collector-emitter saturation voltage	I _C = 10 mA; I _B = 0.5 mA	-	-	150	mV
V _{I(off)}	off-state input voltage	V _{CE} = 5 V; I _C = 100 μA	-	1.1	0.8	V
V _{I(on)}	on-state input voltage	V _{CE} = 0.3 V; I _C = 5 mA	2.5	1.7	-	V
R1	bias resistor 1 (input)		15.4	22	28.6	kΩ
R2/R1	bias resistor ratio		0.8	1	1.2	
C _c	collector capacitance	V _{CB} = 10 V; I _E = I _e = 0 A; f = 1 MHz	-	-	2.5	pF

[1] Pulse test: t_p ≤ 300 μs; δ ≤ 0.02

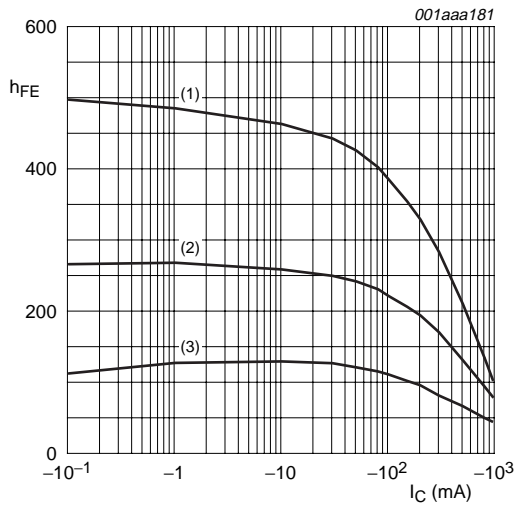

$V_{CE} = -2\text{ V}$
 (1) $T_{amb} = 150\text{ °C}$
 (2) $T_{amb} = 25\text{ °C}$
 (3) $T_{amb} = -55\text{ °C}$

Fig 1. TR1(PNP): DC current gain as a function of collector current; typical values

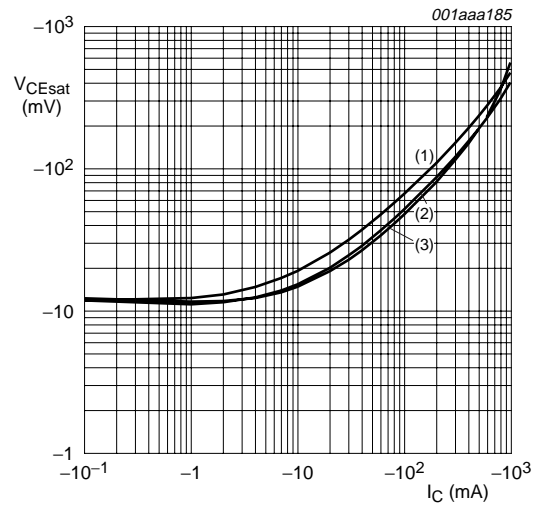

$I_C/I_B = 20$
 (1) $T_{amb} = 150\text{ °C}$
 (2) $T_{amb} = 25\text{ °C}$
 (3) $T_{amb} = -55\text{ °C}$

Fig 2. TR1(PNP): Collector-emitter saturation voltage as a function of collector current; typical values

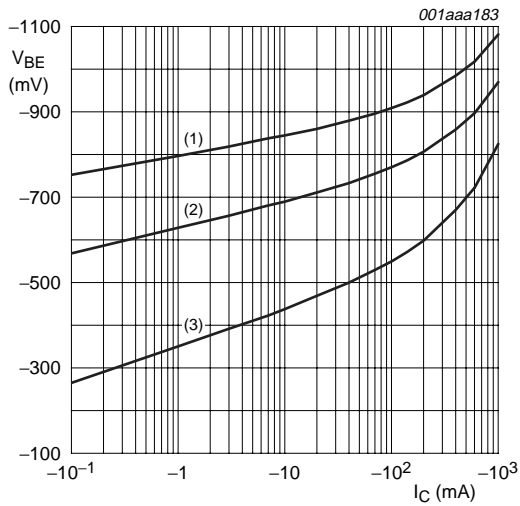

$V_{CE} = -2\text{ V}$
 (1) $T_{amb} = -55\text{ °C}$
 (2) $T_{amb} = 25\text{ °C}$
 (3) $T_{amb} = 150\text{ °C}$

Fig 3. TR1(PNP): Base-emitter voltage as a function of collector current; typical values

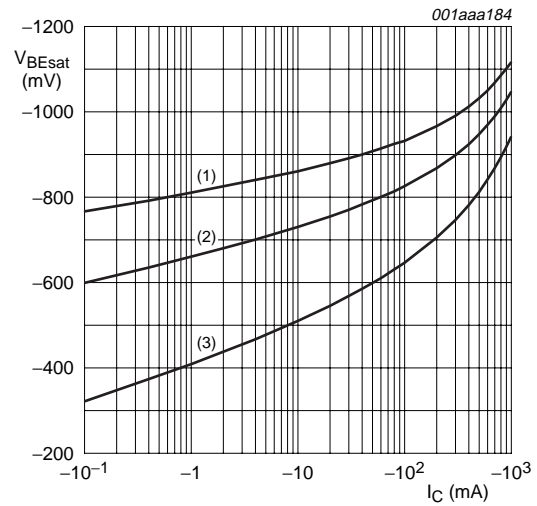

$I_C/I_B = 20$
 (1) $T_{amb} = 150\text{ °C}$
 (2) $T_{amb} = 25\text{ °C}$
 (3) $T_{amb} = -55\text{ °C}$

Fig 4. TR1(PNP): Base-emitter saturation voltage as a function of collector current; typical values

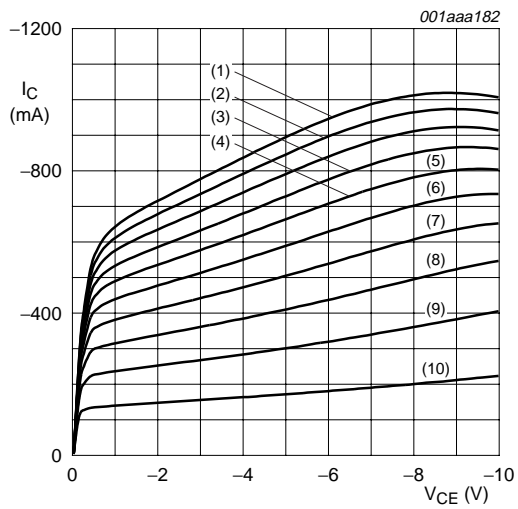

- $T_{amb} = 25\text{ }^{\circ}\text{C}$
- (1) $I_B = -7.0\text{ mA}$
 - (2) $I_B = -6.3\text{ mA}$
 - (3) $I_B = -5.6\text{ mA}$
 - (4) $I_B = -4.9\text{ mA}$
 - (5) $I_B = -4.2\text{ mA}$
 - (6) $I_B = -3.5\text{ mA}$
 - (7) $I_B = -2.8\text{ mA}$
 - (8) $I_B = -2.1\text{ mA}$
 - (9) $I_B = -1.4\text{ mA}$
 - (10) $I_B = -0.7\text{ mA}$

Fig 5. TR1(PNP): Collector current as a function of collector-emitter voltage; typical values

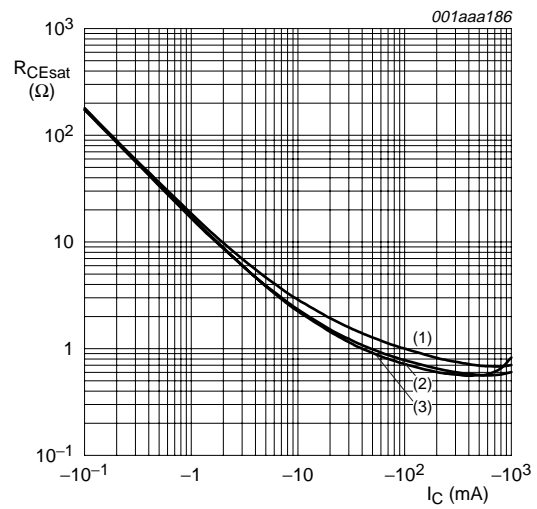

- $I_C/I_B = 20$
- (1) $T_{amb} = -55\text{ }^{\circ}\text{C}$
 - (2) $T_{amb} = 25\text{ }^{\circ}\text{C}$
 - (3) $T_{amb} = 150\text{ }^{\circ}\text{C}$

Fig 6. TR1(PNP): Equivalent on-resistance as a function of collector current; typical values

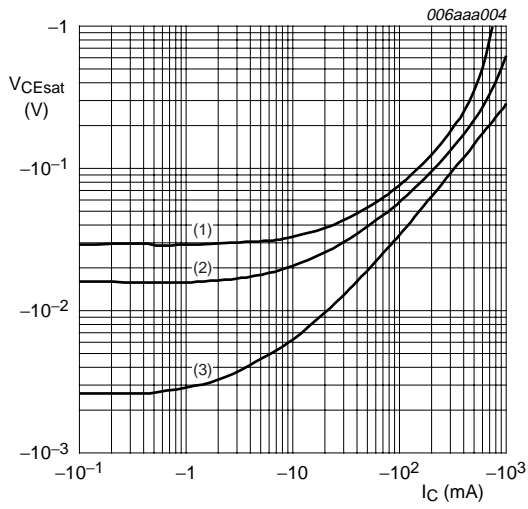

- $T_{amb} = 25\text{ }^\circ\text{C}$
- (1) $I_C/I_B = 100$
 - (2) $I_C/I_B = 50$
 - (3) $I_C/I_B = 10$

Fig 7. TR1(PNP): Collector-emitter saturation voltage as a function of collector current; typical values

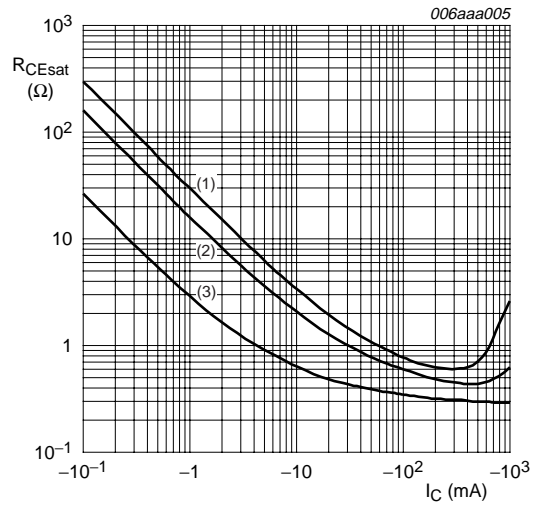

- $T_{amb} = 25\text{ }^\circ\text{C}$
- (1) $I_C/I_B = 100$
 - (2) $I_C/I_B = 50$
 - (3) $I_C/I_B = 10$

Fig 8. TR1(PNP): Equivalent-on resistance as a function of collector current; typical values

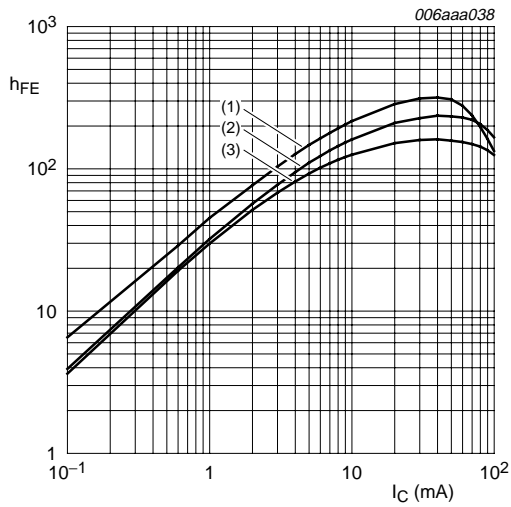

$V_{CE} = 5 \text{ V}$
 (1) $T_{amb} = 150 \text{ }^\circ\text{C}$
 (2) $T_{amb} = 25 \text{ }^\circ\text{C}$
 (3) $T_{amb} = -40 \text{ }^\circ\text{C}$

Fig 9. TR2(NPN): DC current gain as a function of collector current; typical values

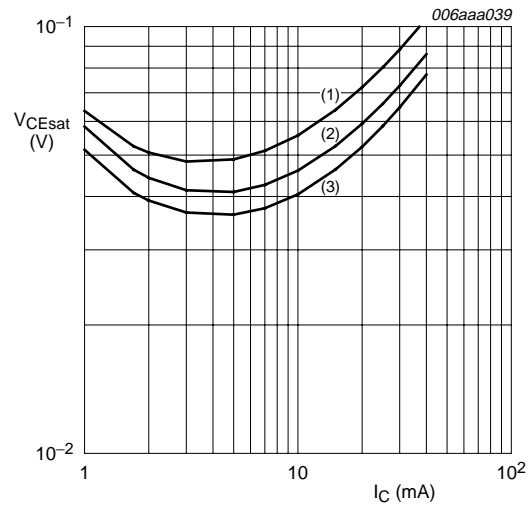

$I_C/I_B = 20$
 (1) $T_{amb} = 100 \text{ }^\circ\text{C}$
 (2) $T_{amb} = 25 \text{ }^\circ\text{C}$
 (3) $T_{amb} = -40 \text{ }^\circ\text{C}$

Fig 10. TR2(NPN): Collector-emitter saturation voltage as a function of collector current; typical values

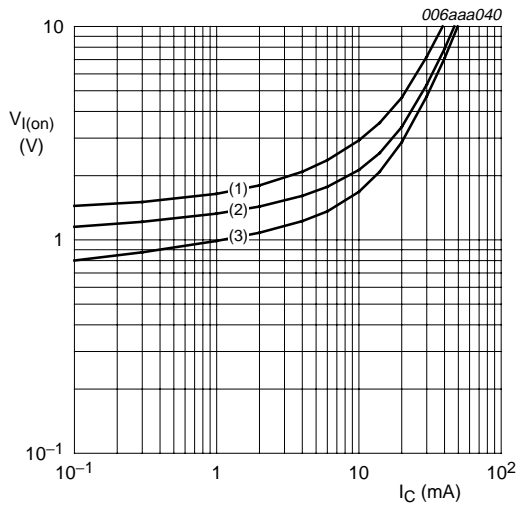

$V_{CE} = 0.3 \text{ V}$
 (1) $T_{amb} = -40 \text{ }^\circ\text{C}$
 (2) $T_{amb} = 25 \text{ }^\circ\text{C}$
 (3) $T_{amb} = 100 \text{ }^\circ\text{C}$

Fig 11. TR2(NPN): On-state input voltage as a function of collector current; typical values

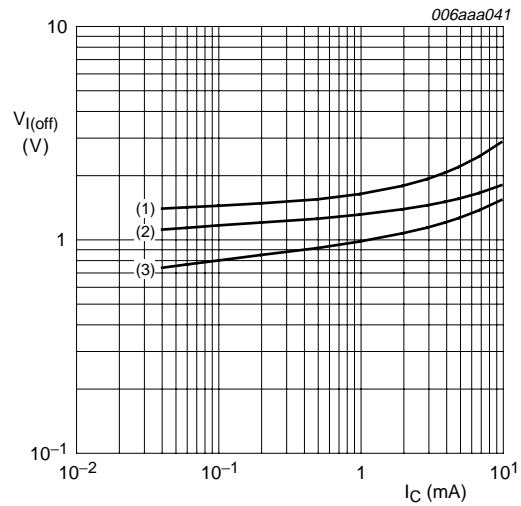

$V_{CE} = 5 \text{ V}$
 (1) $T_{amb} = -40 \text{ }^\circ\text{C}$
 (2) $T_{amb} = 25 \text{ }^\circ\text{C}$
 (3) $T_{amb} = 100 \text{ }^\circ\text{C}$

Fig 12. TR2(NPN): Off-state input voltage as a function of collector current; typical values

8. Package outline

Plastic surface-mounted package; 6 leads

SOT363

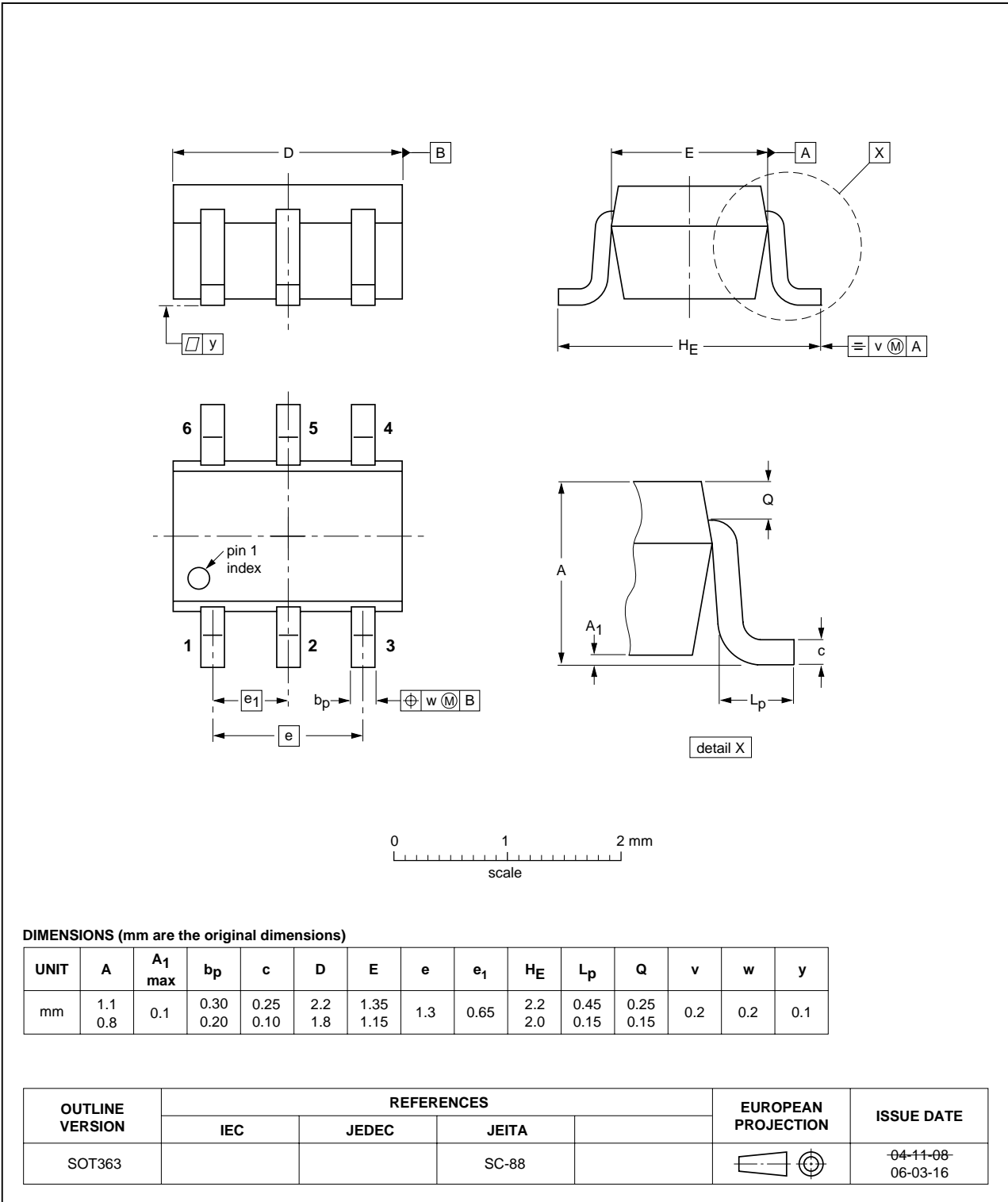

Fig 13. Package outline SOT363 (SC-88)

Plastic surface-mounted package; 6 leads

SOT666

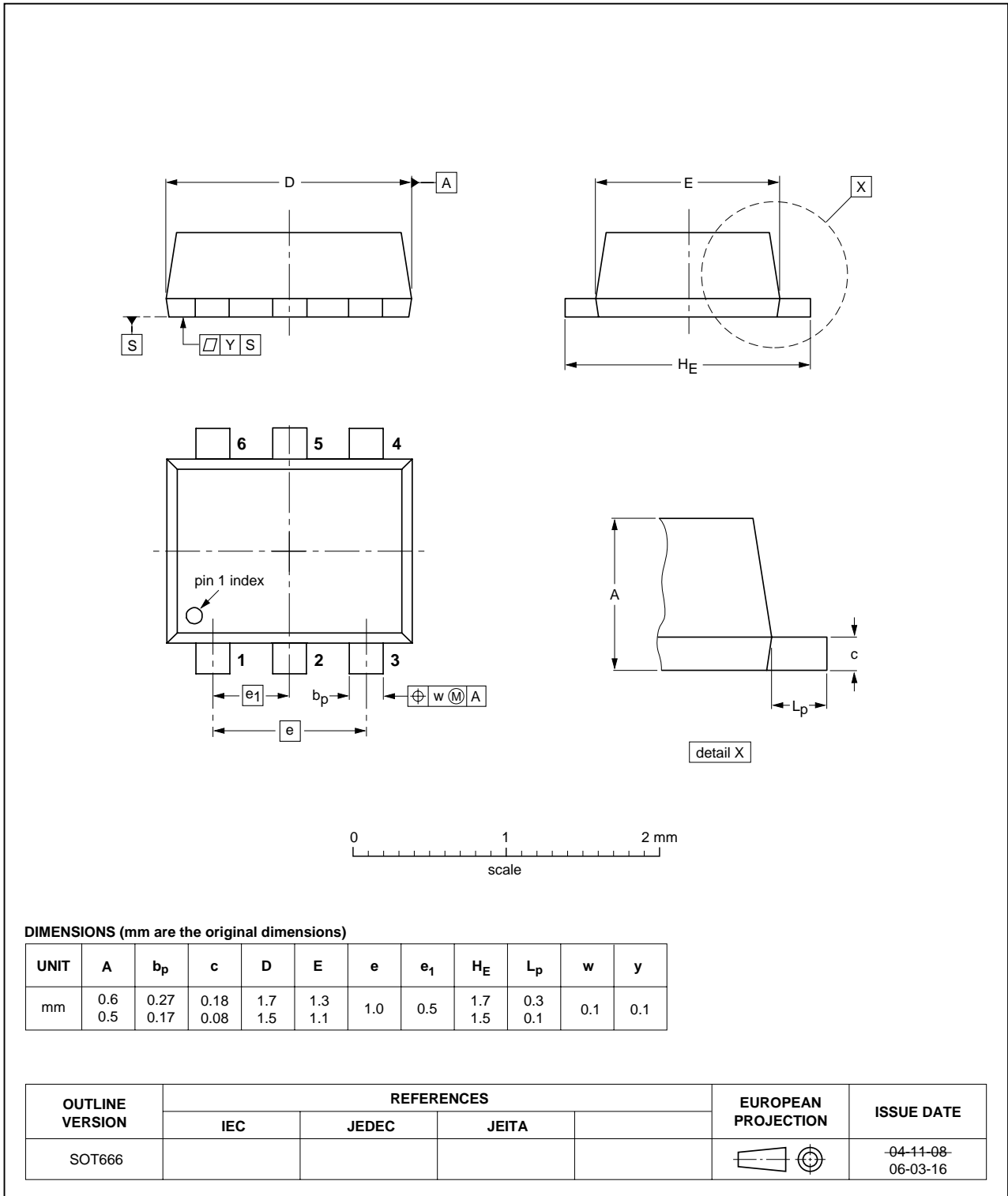

Fig 14. Package outline SOT666

9. Packing information

Table 9. Packing methods

The indicated -xxx are the last three digits of the 12NC ordering code.^[1]

Type number	Package	Description	Packing quantity		
			3000	4000	10000
PBLS1504Y	SOT363	4 mm pitch, 8 mm tape and reel; T1	^[2] -115	-	-135
		4 mm pitch, 8 mm tape and reel; T2	^[3] -125	-	-165
PBLS1504V	SOT666	4 mm pitch, 8 mm tape and reel	-	-115	-

[1] For further information and the availability of packing methods, see [Section 12](#).

[2] T1: normal taping

[3] T2: reverse taping

10. Revision history

Table 10. Revision history

Document ID	Release date	Data sheet status	Change notice	Supersedes
PBL1504Y_PBL1504V_3	20090825	Product data sheet	-	PBL1504Y_PBL1504V_2
Modifications:		<ul style="list-style-type: none">• This data sheet was changed to reflect the new company name NXP Semiconductors, including new legal definitions and disclaimers. No changes were made to the technical content.• Table 3 "Discrete pinning": amended• Figure 13 "Package outline SOT363 (SC-88)": updated• Figure 14 "Package outline SOT666": updated		
PBL1504Y_PBL1504V_2	20041125	Product data sheet	-	PBL1504V_1
PBL1504V_1	20031107	Product specification	-	-

11. Legal information

11.1 Data sheet status

Document status ^{[1][2]}	Product status ^[3]	Definition
Objective [short] data sheet	Development	This document contains data from the objective specification for product development.
Preliminary [short] data sheet	Qualification	This document contains data from the preliminary specification.
Product [short] data sheet	Production	This document contains the product specification.

[1] Please consult the most recently issued document before initiating or completing a design.

[2] The term 'short data sheet' is explained in section "Definitions".

[3] The product status of device(s) described in this document may have changed since this document was published and may differ in case of multiple devices. The latest product status information is available on the Internet at URL <http://www.nxp.com>.

11.2 Definitions

Draft — The document is a draft version only. The content is still under internal review and subject to formal approval, which may result in modifications or additions. NXP Semiconductors does not give any representations or warranties as to the accuracy or completeness of information included herein and shall have no liability for the consequences of use of such information.

Short data sheet — A short data sheet is an extract from a full data sheet with the same product type number(s) and title. A short data sheet is intended for quick reference only and should not be relied upon to contain detailed and full information. For detailed and full information see the relevant full data sheet, which is available on request via the local NXP Semiconductors sales office. In case of any inconsistency or conflict with the short data sheet, the full data sheet shall prevail.

11.3 Disclaimers

General — Information in this document is believed to be accurate and reliable. However, NXP Semiconductors does not give any representations or warranties, expressed or implied, as to the accuracy or completeness of such information and shall have no liability for the consequences of use of such information.

Right to make changes — NXP Semiconductors reserves the right to make changes to information published in this document, including without limitation specifications and product descriptions, at any time and without notice. This document supersedes and replaces all information supplied prior to the publication hereof.

Suitability for use — NXP Semiconductors products are not designed, authorized or warranted to be suitable for use in medical, military, aircraft, space or life support equipment, nor in applications where failure or malfunction of an NXP Semiconductors product can reasonably be expected to result in personal injury, death or severe property or environmental

damage. NXP Semiconductors accepts no liability for inclusion and/or use of NXP Semiconductors products in such equipment or applications and therefore such inclusion and/or use is at the customer's own risk.

Applications — Applications that are described herein for any of these products are for illustrative purposes only. NXP Semiconductors makes no representation or warranty that such applications will be suitable for the specified use without further testing or modification.

Limiting values — Stress above one or more limiting values (as defined in the Absolute Maximum Ratings System of IEC 60134) may cause permanent damage to the device. Limiting values are stress ratings only and operation of the device at these or any other conditions above those given in the Characteristics sections of this document is not implied. Exposure to limiting values for extended periods may affect device reliability.

Terms and conditions of sale — NXP Semiconductors products are sold subject to the general terms and conditions of commercial sale, as published at <http://www.nxp.com/profile/terms>, including those pertaining to warranty, intellectual property rights infringement and limitation of liability, unless explicitly otherwise agreed to in writing by NXP Semiconductors. In case of any inconsistency or conflict between information in this document and such terms and conditions, the latter will prevail.

No offer to sell or license — Nothing in this document may be interpreted or construed as an offer to sell products that is open for acceptance or the grant, conveyance or implication of any license under any copyrights, patents or other industrial or intellectual property rights.

Export control — This document as well as the item(s) described herein may be subject to export control regulations. Export might require a prior authorization from national authorities.

Quick reference data — The Quick reference data is an extract of the product data given in the Limiting values and Characteristics sections of this document, and as such is not complete, exhaustive or legally binding.

11.4 Trademarks

Notice: All referenced brands, product names, service names and trademarks are the property of their respective owners.

12. Contact information

For more information, please visit: <http://www.nxp.com>

For sales office addresses, please send an email to: salesaddresses@nxp.com

13. Contents

1	Product profile	1
1.1	General description	1
1.2	Features	1
1.3	Applications	1
1.4	Quick reference data	1
2	Pinning information	2
3	Ordering information	2
4	Marking	2
5	Limiting values	3
6	Thermal characteristics	3
7	Characteristics	4
8	Package outline	9
9	Packing information	11
10	Revision history	12
11	Legal information	13
11.1	Data sheet status	13
11.2	Definitions	13
11.3	Disclaimers	13
11.4	Trademarks	13
12	Contact information	13
13	Contents	14

Please be aware that important notices concerning this document and the product(s) described herein, have been included in section 'Legal information'.



© NXP B.V. 2009.

All rights reserved.

For more information, please visit: <http://www.nxp.com>



For sales office addresses, please send an email to: salesaddresses@nxp.com

Date of release: 25 August 2009

Document identifier: PBLS1504Y_PBL1504V_3

Looking for pricing, stock, or lifecycle information?

Click below to explore more details on WIN SOURCE:

-  [View PBL51504V,115 on WIN SOURCE](#)
-  [NXP / Nexperia Information](#)

Optimize Your Supply Chain with WIN SOURCE Solutions

-  Global Sourcing Solution
-  Obsolete Management
-  Cost Control Management
-  Shortage Management
-  Alternative Solution
-  Excess Inventory Management