



THE DATASHEET OF
3N163



3N163/3N164

P-Channel Enhancement-Mode MOSFET Transistors

Product Summary

Part Number	$V_{(BR)DSS}$ Min (V)	$V_{GS(th)}$ (V)	$r_{DS(on)}$ Max (Ω)	$I_{D(on)}$ Min (mA)	C_{rss} Max (pF)	t_{ON} Typ (ns)
3N163	-40	-2 to -5	250	-5	0.7	18
3N164	-30	-2 to -5	300	-3	0.7	18

Features

- Ultra-Low Input Leakage: 0.02 pA Typ.
- High Gate Breakdown Voltage: ± 125 V
- Normally Off

Benefits

- High Input Impedance Isolation
- Minimize Handling ESD Problems
- High Off Isolation without Power

Applications

- Ultra-High Input Impedance Amplifier
- Smoke Detectors
- Electrometers
- Analog Switching
- Digital Switching

Description

The 3N163/164 are lateral p-channel MOSFETs designed for analog switch and preamplifier applications where high speed and low parasitic capacitances are required.

The hermetic TO-206AF package is compatible with military processing per military standards (see Military information).

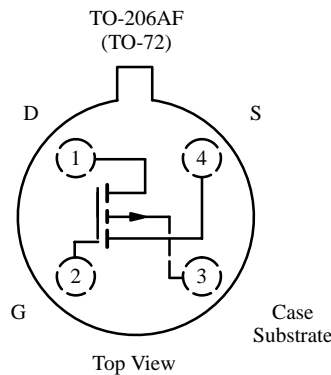

Absolute Maximum Ratings ($T_A = 25^\circ\text{C}$ Unless Otherwise Noted)

Drain-Source Voltage (3N163)	-40 V	Storage Temperature	-65 to 200°C
(3N164)	-30 V	Operating Junction Temperature	-55 to 150°C
Gate-Source Voltage	± 30 V	Power Dissipation ^a	375 mW
Continuous Drain Current	-50 mA	Notes:	
Lead Temperature ($1/16$ " from case for 10 seconds)	300°C	a. Derate 3 mW/°C above 25°C	

Updates to this data sheet may be obtained via facsimile by calling Siliconix FaxBack, 1-408-970-5600. Please request FaxBack document #70228.

3N163/3N164

Specifications^a

Parameter	Symbol	Test Conditions	Typ ^b	Limits				Unit
				3N163		3N164		
				Min	Max	Min	Max	
Static								
Drain-Source Breakdown Voltage	$V_{(BR)DSS}$	$I_D = -10 \mu A, V_{DS} = 0 V$	-70	-40		-30		V
Source-Drain Breakdown Voltage	$V_{(BR)SDS}$	$I_S = -10 \mu A, V_{GD} = V_{BD} = 0 V$	-70	-40		-30		
Gate-Threshold Voltage	$V_{GS(th)}$	$I_D = -10 \mu A, V_{GS} = V_{DS}$	-2.5	-2	-5	-2	-5	
Gate-Source Voltage	V_{GS}	$I_D = -0.5 mA, V_{DS} = -15 V$	-3.5	-3	-6.5	-2.5	-6.5	
Gate-Body Leakage	I_{GSS}	$V_{GS} = -40 V, V_{DS} = 0 V$	<-1		-10			pA
		$T_A = 125^\circ C^d$	-1					
		$V_{GS} = -30 V, V_{DS} = 0 V$	<-1				-10	
Zero-Gate Voltage Drain Current	I_{DSS}	$V_{DS} = -15 V, V_{GS} = 0 V$	-8		-200		-400	nA
		$T_A = 125^\circ C^d$	-20					
Zero-Gate Voltage Source Current	I_{SDS}	$V_{GD} = V_{BD} = 0 V, V_{SD} = -20 V$	-10		-400		-800	pA
		$T_A = 125^\circ C^d$	-25					nA
On-State Drain Current ^c	$I_{D(on)}$	$V_{DS} = -15 V, V_{GS} = -10 V$	-10	-5	-30	-3	-30	mA
Drain-Source On-Resistance	$r_{DS(on)}$	$V_{GS} = -20 V, I_D = -100 \mu A$	180		250		300	Ω
		$T_A = 125^\circ C^d$	270					
Dynamic								
Forward Transconductance ^c	g_{fs}	$V_{DS} = -15 V, I_D = -10 mA$ $f = 1 kHz$	2.7	2	4	1	4	mS
Common-Source Output Conductance ^c	g_{os}		150		250		250	μS
Input Capacitance	C_{iss}	$V_{DS} = -15 V, I_D = -10 mA$ $f = 1 MHz$	2.4		3.5		3.5	pF
Output Capacitance	C_{oss}		2.5		3		3	
Reverse Transfer Capacitance	C_{rss}		0.5		0.7		0.7	
Switching^e								
Turn-On Time	$t_{d(on)}$	$V_{DD} = -15 V, R_L = 1500 \Omega$ $I_D \cong -10 mA, V_{GEN} = -12 V$ $R_G = 50 \Omega$	5		12		12	ns
	t_r		13		24		24	
Turn-Off Time	$t_{d(off)}$		25		50		50	

Notes:

- $T_A = 25^\circ C$ unless otherwise noted.
- Typical values are for DESIGN AID ONLY, not guaranteed nor subject to production testing.
- Pulse test: $PW \leq 300 \mu s$ duty cycle $\leq 3\%$.
- This parameter not registered with JEDEC.
- Switching time is essentially independent of operating temperature.

MRA

Typical Characteristics

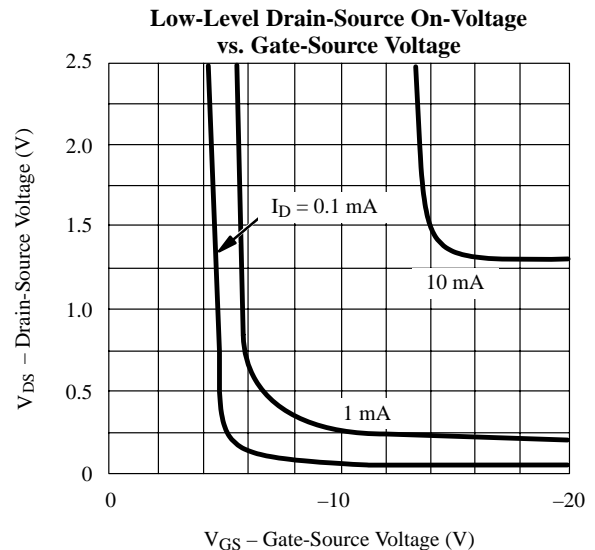
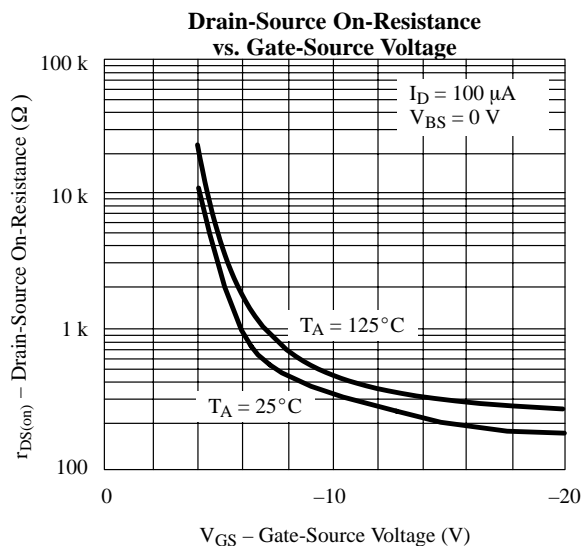
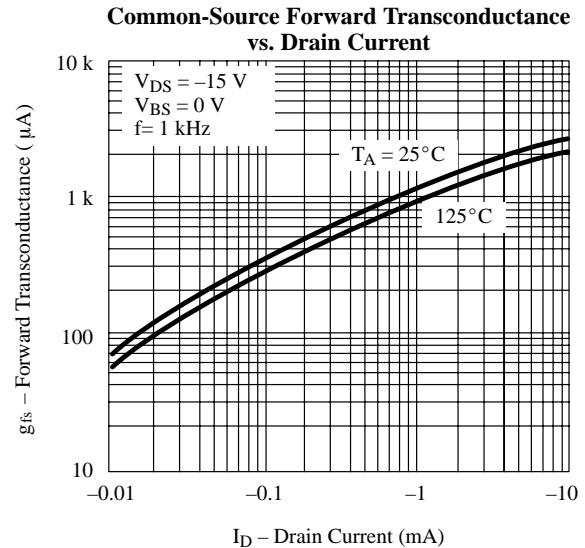
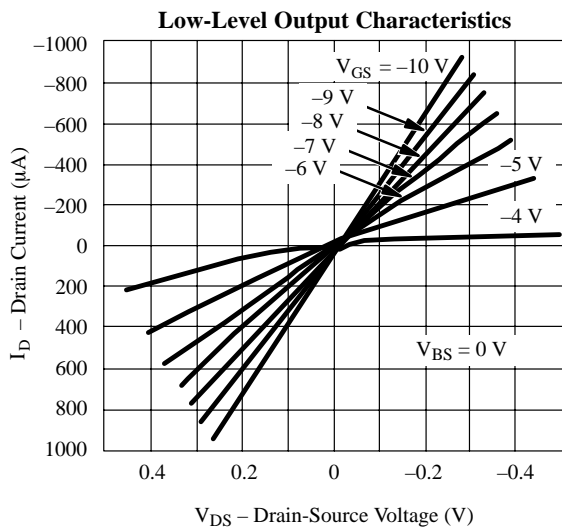
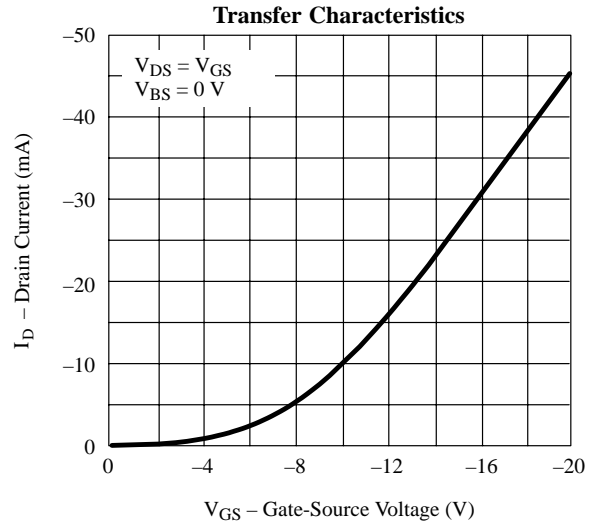
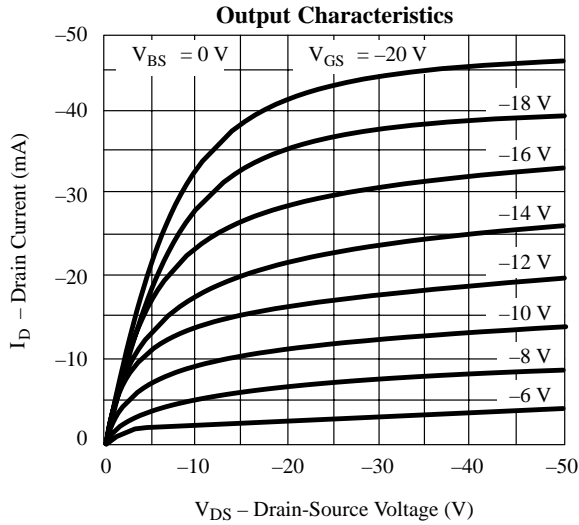

3N163/3N164

Typical Characteristics (Cont'd)

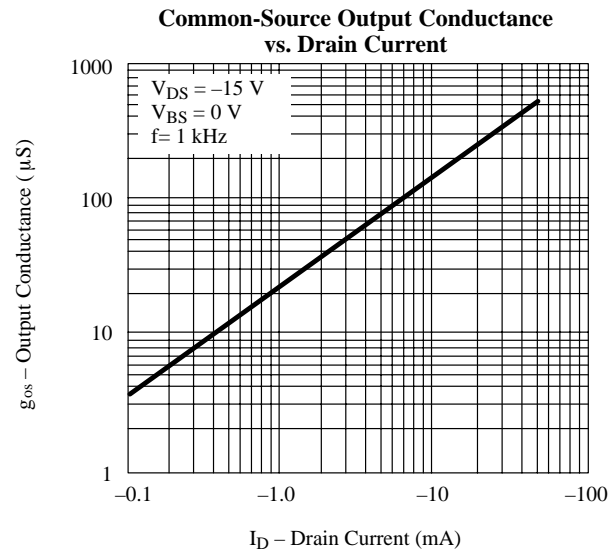
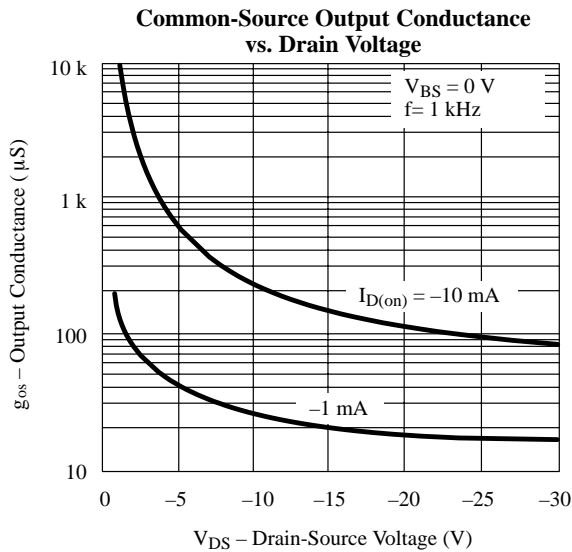
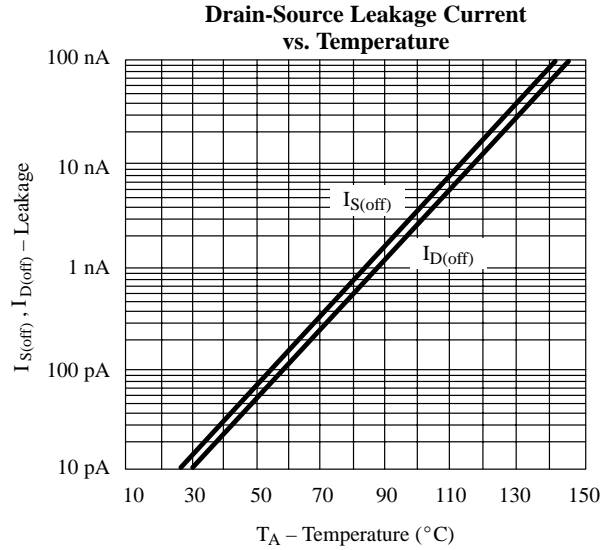
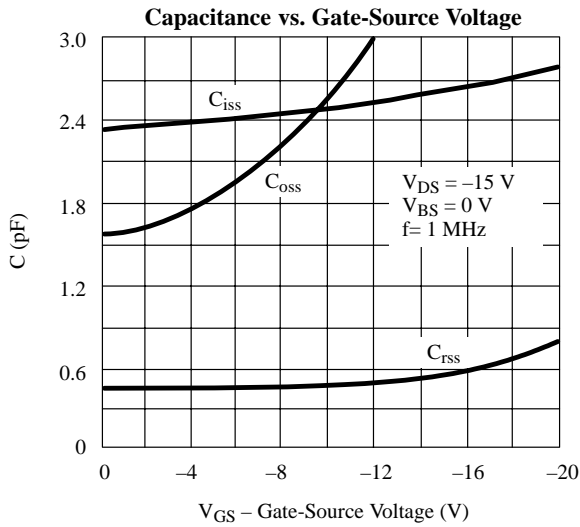

Switching Time Test Circuit

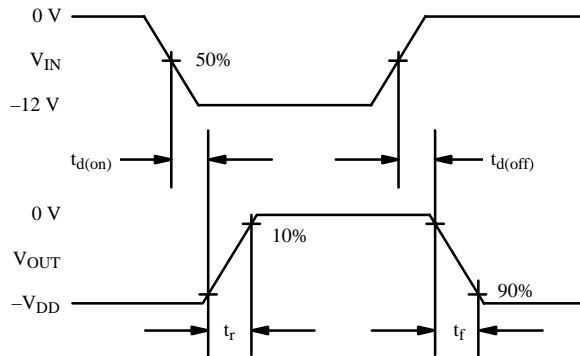
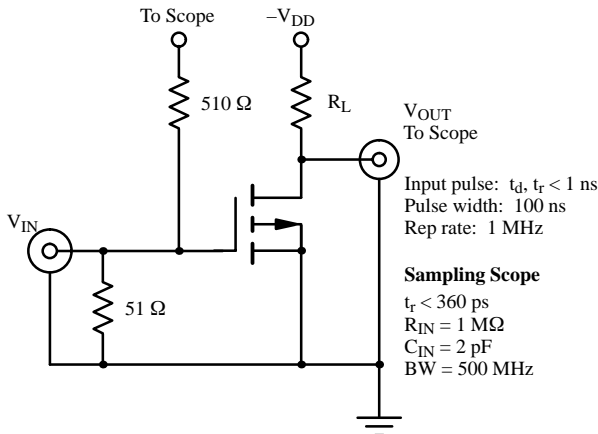



Disclaimer

All product specifications and data are subject to change without notice.

Vishay Intertechnology, Inc., its affiliates, agents, and employees, and all persons acting on its or their behalf (collectively, "Vishay"), disclaim any and all liability for any errors, inaccuracies or incompleteness contained herein or in any other disclosure relating to any product.

Vishay disclaims any and all liability arising out of the use or application of any product described herein or of any information provided herein to the maximum extent permitted by law. The product specifications do not expand or otherwise modify Vishay's terms and conditions of purchase, including but not limited to the warranty expressed therein, which apply to these products.

No license, express or implied, by estoppel or otherwise, to any intellectual property rights is granted by this document or by any conduct of Vishay.

The products shown herein are not designed for use in medical, life-saving, or life-sustaining applications unless otherwise expressly indicated. Customers using or selling Vishay products not expressly indicated for use in such applications do so entirely at their own risk and agree to fully indemnify Vishay for any damages arising or resulting from such use or sale. Please contact authorized Vishay personnel to obtain written terms and conditions regarding products designed for such applications.

Product names and markings noted herein may be trademarks of their respective owners.

Looking for pricing, stock, or lifecycle information?

Click below to explore more details on WIN SOURCE:

 [View 3N163 on WIN SOURCE](#)

 [Vishay Information](#)

Optimize Your Supply Chain with WIN SOURCE Solutions

-  Global Sourcing Solution
-  Obsolete Management
-  Cost Control Management
-  Shortage Management
-  Alternative Solution
-  Excess Inventory Management