



THE DATASHEET OF PD438B



4.8mm Semi-Lens Silicon PIN Photodiode PD438B

Features

- Fast response times
- High photo sensitivity
- Small junction capacitance
- Pb free
- The product itself will remain within RoHS compliant version.
- Compliance with EU REACH

Description

- PD438B is a high speed and sensitive PIN photodiode in a cylindrical side view plastic package. The epoxy package itself is an IR filter , spectrally matched to IR emitter.

Applications

- High speed photo detector
- Camera
- Optoelectronic switch
- VCRs , Video camera

Device Selection Guide

Chip Materials	Lens Color
Silicon	Black

Absolute Maximum Ratings (Ta=25°C)

Parameter	Symbol	Rating	Unit
Reverse Voltage	V_R	32	mA
Power Dissipation	P_d	150	mW
Operating Temperature	T_{opr}	-40 ~ +85	°C
Storage Temperature	T_{stg}	-40 ~ +100	°C
Soldering Temperature(*1)	T_{sol}	260	°C

Notes: *1: Soldering time \leq 5 seconds.

:

Electro-Optical Characteristics (Ta=25°C)

Parameter	Symbol	Min.	Typ.	Max.	Unit	Condition
Rang of Spectral Bandwidth	$\lambda_{0.5}$	400	-----	1100	nm	-----
Wavelength of Peak Sensitivity	λ_p	-----	940	-----	nm	-----
Open-Circuit Voltage	VOC	-----	0.35	-----	V	Ee=5m W/cm2 $\lambda_p=940\text{nm}$
Short- Circuit Current	ISC	-----	18	-----	μA	Ee=1m W/cm2 $\lambda_p=940\text{nm}$
Reverse Light Current	I_L	10.2	18	-----	μA	Ee=1m W/cm2 $\lambda_p=940\text{nm}$ VR=5V
Dark Current	I_d	----	5	30	nA	Ee=0m W/cm2 VR=10V
Reverse Breakdown	BVR	32	170	-----	V	Ee=0m W/cm2 IR=100 μA
Total Capacitance	Ct	----	25	----	pF	Ee=0m W/cm2 VR=3V f=1MHZ
Rise/Fall Time	tr/tf	----	50/50	----	nS	VR=10V RL=1K Ω

Note:

Tolerance of Luminous Intensity: $\pm 10\%$
Tolerance of Dominant Wavelength: $\pm 1\text{nm}$
Tolerance of Forward Voltage: $\pm 0.1\text{V}$

Typical Electro-Optical Characteristics Curves

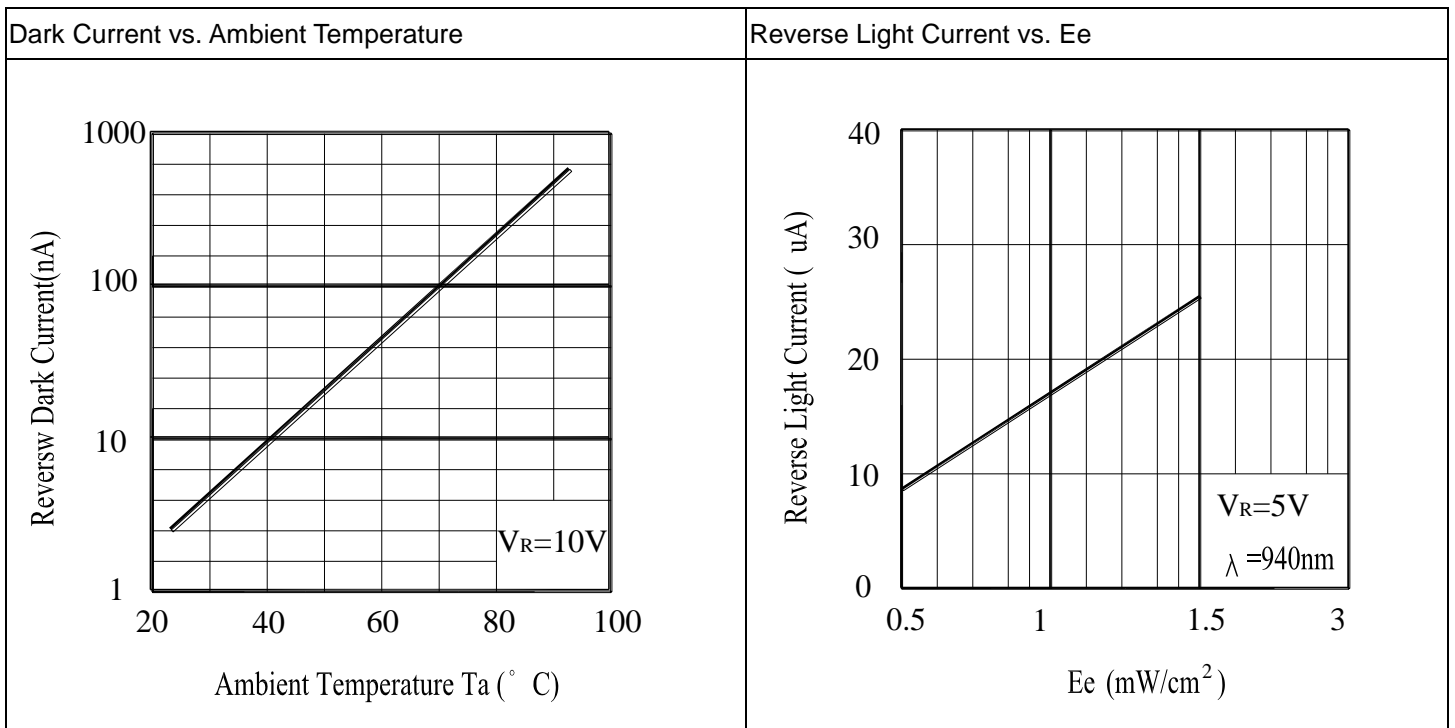
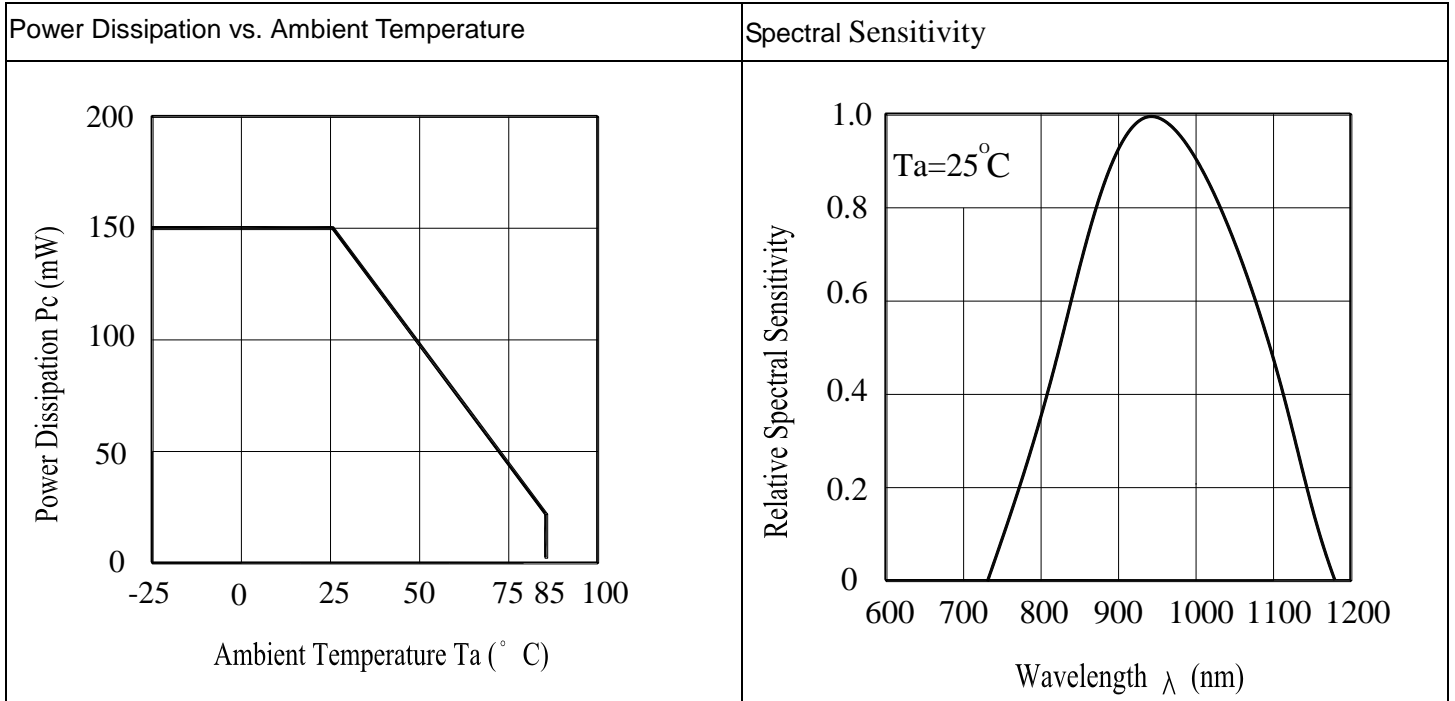

Terminal Capacitance vs. Reverse Voltage

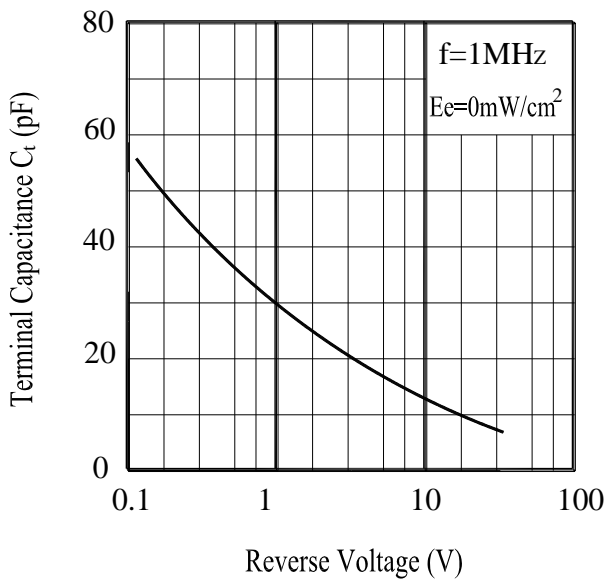

Response Time vs. Load Resistance

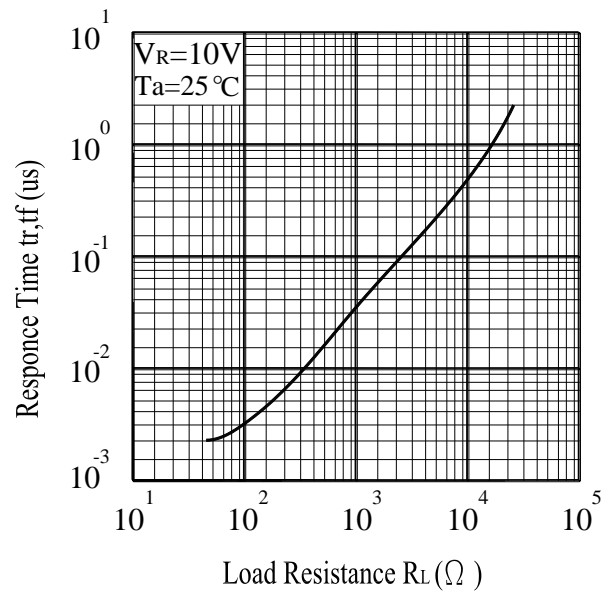

Package Dimension

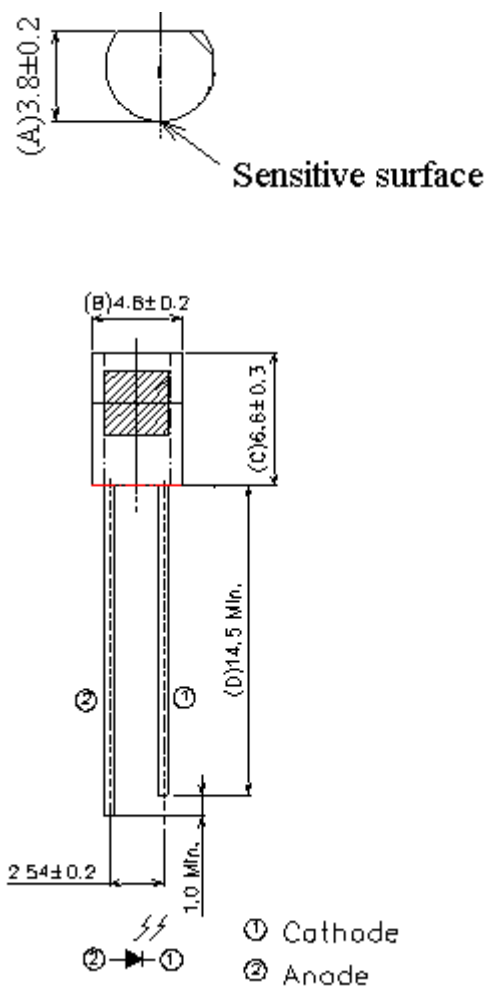

Note: Tolerances unless dimensions ± 0.25 mm

Packing Specification

- Packing Quantity
- 1. 500 PCS/1 Bag, 6Bags/1 Inner Carton
- 2. 10Inner Cartons/1 Outside Carton

Label Form Specification



- CPN: Customer's Product Number
- P/N: Product Number
- QTY: Packing Quantity
- CAT: Luminous Intensity Rank
- HUE: Dom. Wavelength Rank
- REF: Forward Voltage Rank
- LOT No: Lot Number
- Reference: Identify Label Number

Notes:



1. Above specification may be changed without notice. EVERLIGHT will reserve authority on material change for above specification.
2. When using this product, please observe the absolute maximum ratings and the instructions for using outlined in these specification sheets. EVERLIGHT assumes no responsibility for any damage resulting from use of the product which does not comply with the absolute maximum ratings and the instructions included in these specification sheets.
3. These specification sheets include materials protected under copyright of EVERLIGHT corporation. Please don't reproduce or cause anyone to reproduce them without EVERLIGHT's consent.

DISCLAIMER

1. EVERLIGHT reserves the right(s) on the adjustment of product material mix for the specification.
2. The product meets EVERLIGHT published specification for a period of twelve (12) months from date of shipment.
3. The graphs shown in this datasheet are representing typical data only and do not show guaranteed values.
4. When using this product, please observe the absolute maximum ratings and the instructions for using outlined in these specification sheets. EVERLIGHT assumes no responsibility for any damage resulting from the use of the product which does not comply with the absolute maximum ratings and the instructions included in these specification sheets.
5. These specification sheets include materials protected under copyright of EVERLIGHT. Reproduction in any form is prohibited without obtaining EVERLIGHT's prior consent.
6. This product is not intended to be used for military, aircraft, automotive, medical, life sustaining or life saving applications or any other application which can result in human injury or death. Please contact authorized Everlight sales agent for special application request.

Looking for pricing, stock, or lifecycle information?

Click below to explore more details on WIN SOURCE:

-  [View PD438B on WIN SOURCE](#)
-  [Everlight Electronics Co Ltd Information](#)

Optimize Your Supply Chain with WIN SOURCE Solutions

-  Global Sourcing Solution
-  Obsolete Management
-  Cost Control Management
-  Shortage Management
-  Alternative Solution
-  Excess Inventory Management