



THE DATASHEET OF PDTC124XE



Important notice

Dear Customer,

On 7 February 2017 the former NXP Standard Product business became a new company with the tradename **Nexperia**. Nexperia is an industry leading supplier of Discrete, Logic and PowerMOS semiconductors with its focus on the automotive, industrial, computing, consumer and wearable application markets

In data sheets and application notes which still contain NXP or Philips Semiconductors references, use the references to Nexperia, as shown below.

Instead of <http://www.nxp.com>, <http://www.philips.com/> or <http://www.semiconductors.philips.com/>, use <http://www.nexperia.com>

Instead of sales.addresses@www.nxp.com or sales.addresses@www.semiconductors.philips.com, use salesaddresses@nexperia.com (email)

Replace the copyright notice at the bottom of each page or elsewhere in the document, depending on the version, as shown below:

- © NXP N.V. (year). All rights reserved or © Koninklijke Philips Electronics N.V. (year). All rights reserved

Should be replaced with:

- © **Nexperia B.V. (year). All rights reserved.**

If you have any questions related to the data sheet, please contact our nearest sales office via e-mail or telephone (details via salesaddresses@nexperia.com). Thank you for your cooperation and understanding,

Kind regards,

Team Nexperia

PDTC124X series

NPN resistor-equipped transistors; R1 = 22 k Ω , R2 = 47 k Ω

Rev. 07 — 16 November 2009

Product data sheet

1. Product profile

1.1 General description

NPN Resistor-Equipped Transistors (RET) family.

Table 1. Product overview

Type number	Package			PNP complement
	NXP	JEITA	JEDEC	
PDTC124XE	SOT416	SC-75	-	PDTA124XE
PDTC124XEF	SOT490	SC-89	-	PDTA124XEF
PDTC124XK	SOT346	SC-59A	TO-236	PDTA124XK
PDTC124XM	SOT883	SC-101	-	PDTA124XM
PDTC124XS ^[1]	SOT54	SC-43A	TO-92	PDTA124XS
PDTC124XT	SOT23	-	TO-236AB	PDTA124XT
PDTC124XU	SOT323	SC-70	-	PDTA124XU

[1] Also available in SOT54A and SOT54 variant packages (see [Section 2](#)).

1.2 Features

- Built-in bias resistors
- Simplifies circuit design
- Reduces component count
- Reduces pick and place costs

1.3 Applications

- General-purpose switching and amplification
- Inverter and interface circuits
- Circuit drivers

1.4 Quick reference data

Table 2. Quick reference data

Symbol	Parameter	Conditions	Min	Typ	Max	Unit
V _{CEO}	collector-emitter voltage	open base	-	-	50	V
I _O	output current		-	-	100	mA
R1	bias resistor 1 (input)		15.4	22	28.6	k Ω
R2/R1	bias resistor ratio		1.7	2.1	2.6	

2. Pinning information

Table 3. Pinning

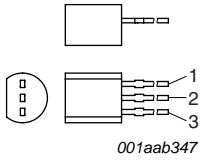
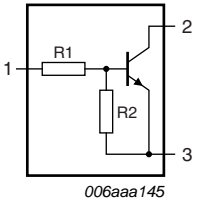
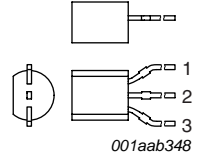
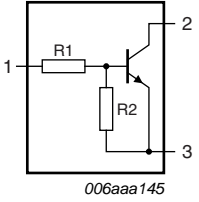
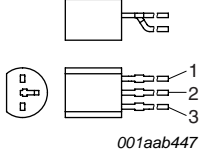
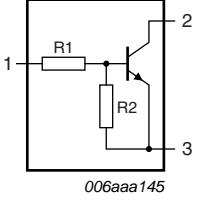
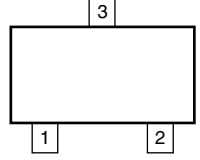
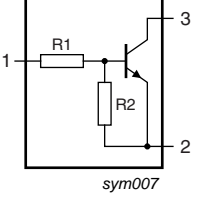
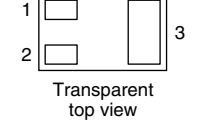
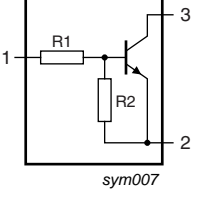
Pin	Description	Simplified outline	Symbol
SOT54			
1	input (base)	 <p>001aab347</p>	 <p>006aaa145</p>
2	output (collector)		
3	GND (emitter)		
SOT54A			
1	input (base)	 <p>001aab348</p>	 <p>006aaa145</p>
2	output (collector)		
3	GND (emitter)		
SOT54 variant			
1	input (base)	 <p>001aab447</p>	 <p>006aaa145</p>
2	output (collector)		
3	GND (emitter)		
SOT23; SOT323; SOT346; SOT416; SOT490			
1	input (base)	 <p>006aaa144</p>	 <p>sym007</p>
2	GND (emitter)		
3	output (collector)		
SOT883			
1	input (base)	 <p>Transparent top view</p>	 <p>sym007</p>
2	GND (emitter)		
3	output (collector)		

3. Ordering information

Table 4. Ordering information

Type number	Package		Version
	Name	Description	
PDTC124XE	SC-75	plastic surface mounted package; 3 leads	SOT416
PDTC124XEF	SC-89	plastic surface mounted package; 3 leads	SOT490
PDTC124XK	SC-59A	plastic surface mounted package; 3 leads	SOT346
PDTC124XM	SC-101	leadless ultra small plastic package; 3 solder lands; body 1.0 × 0.6 × 0.5 mm	SOT883
PDTC124XS ^[1]	SC-43A	plastic single-ended leaded (through hole) package; 3 leads	SOT54
PDTC124XT	-	plastic surface mounted package; 3 leads	SOT23
PDTC124XU	SC-70	plastic surface mounted package; 3 leads	SOT323

[1] Also available in SOT54A and SOT54 variant packages (see [Section 2](#) and [Section 9](#)).

4. Marking

Table 5. Marking codes

Type number	Marking code ^[1]
PDTC124XE	32
PDTC124XEF	32
PDTC124XK	51
PDTC124XM	DZ
PDTC124XS	TC124X
PDTC124XT	*46
PDTC124XU	*51

[1] * = -: made in Hong Kong
 * = p: made in Hong Kong
 * = t: made in Malaysia
 * = W: made in China

5. Limiting values

Table 6. Limiting values

In accordance with the Absolute Maximum Rating System (IEC 60134).

Symbol	Parameter	Conditions	Min	Max	Unit	
V _{CBO}	collector-base voltage	open emitter	-	50	V	
V _{CEO}	collector-emitter voltage	open base	-	50	V	
V _{EBO}	emitter-base voltage	open collector	-	7	V	
V _I	input voltage					
	positive		-	+40	V	
	negative		-	-7	V	
I _O	output current		-	100	mA	
I _{CM}	peak collector current	single pulse; t _p ≤ 1 ms	-	100	mA	
P _{tot}	total power dissipation	T _{amb} ≤ 25 °C				
	SOT416		[1]	-	150	mW
	SOT490		[1][2]	-	250	mW
	SOT346		[1]	-	250	mW
	SOT883		[2][3]	-	250	mW
	SOT54		[1]	-	500	mW
	SOT23		[1]	-	250	mW
	SOT323		[1]	-	200	mW
T _{stg}	storage temperature		-65	+150	°C	
T _j	junction temperature		-	150	°C	
T _{amb}	ambient temperature		-65	+150	°C	

[1] Device mounted on an FR4 Printed-Circuit Board (PCB), single-sided copper, tin-plated and standard footprint.

[2] Reflow soldering is the only recommended soldering method.

[3] Device mounted on an FR4 PCB with 60 μ m copper strip line, standard footprint.

6. Thermal characteristics

Table 7. Thermal characteristics

Symbol	Parameter	Conditions	Min	Typ	Max	Unit
$R_{th(j-a)}$	thermal resistance from junction to ambient	in free air				
	SOT416		[1]	-	833	K/W
	SOT490		[1][2]	-	500	K/W
	SOT346		[1]	-	500	K/W
	SOT883		[2][3]	-	500	K/W
	SOT54		[1]	-	250	K/W
	SOT23		[1]	-	500	K/W
	SOT323		[1]	-	625	K/W

[1] Device mounted on an FR4 PCB, single-sided copper, tin-plated and standard footprint.

[2] Reflow soldering is the only recommended soldering method.

[3] Device mounted on an FR4 PCB with 60 μ m copper strip line, standard footprint.

7. Characteristics

Table 8. Characteristics

$T_{amb} = 25$ °C unless otherwise specified.

Symbol	Parameter	Conditions	Min	Typ	Max	Unit
I_{CBO}	collector-base cut-off current	$V_{CB} = 50$ V; $I_E = 0$ A	-	-	100	nA
I_{CEO}	collector-emitter cut-off current	$V_{CE} = 30$ V; $I_B = 0$ A	-	-	1	μ A
		$V_{CE} = 30$ V; $I_B = 0$ A; $T_j = 150$ °C	-	-	50	μ A
I_{EBO}	emitter-base cut-off current	$V_{EB} = 5$ V; $I_C = 0$ A	-	-	120	μ A
h_{FE}	DC current gain	$V_{CE} = 5$ V; $I_C = 5$ mA	80	-	-	
V_{CEsat}	collector-emitter saturation voltage	$I_C = 10$ mA; $I_B = 0.5$ mA	-	-	150	mV
$V_{I(off)}$	off-state input voltage	$V_{CE} = 5$ V; $I_C = 100$ μ A	-	0.8	0.5	V
$V_{I(on)}$	on-state input voltage	$V_{CE} = 300$ mV; $I_C = 2$ mA	2	1.1	-	V
R1	bias resistor 1 (input)		15.4	22	28.6	k Ω
R2/R1	bias resistor ratio		1.7	2.1	2.6	
C_c	collector capacitance	$V_{CB} = 10$ V; $I_E = i_e = 0$ A; $f = 1$ MHz	-	-	2.5	pF

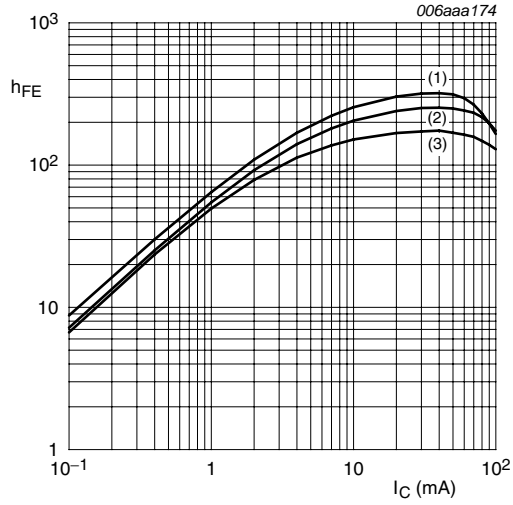

$V_{CE} = 5\text{ V}$
 (1) $T_{amb} = 100\text{ °C}$
 (2) $T_{amb} = 25\text{ °C}$
 (3) $T_{amb} = -40\text{ °C}$

Fig 1. DC current gain as a function of collector current; typical values

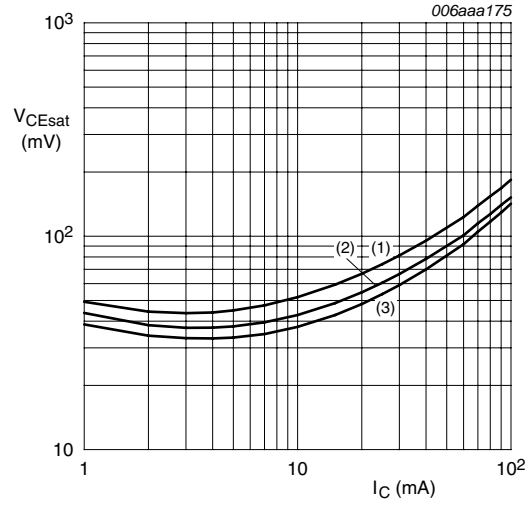

$I_C/I_B = 20$
 (1) $T_{amb} = 100\text{ °C}$
 (2) $T_{amb} = 25\text{ °C}$
 (3) $T_{amb} = -40\text{ °C}$

Fig 2. Collector-emitter saturation voltage as a function of collector current; typical values

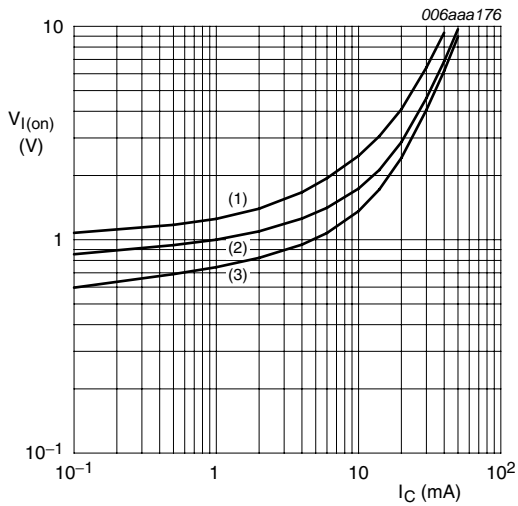

$V_{CE} = 0.3\text{ V}$
 (1) $T_{amb} = -40\text{ °C}$
 (2) $T_{amb} = 25\text{ °C}$
 (3) $T_{amb} = 100\text{ °C}$

Fig 3. On-state input voltage as a function of collector current; typical values

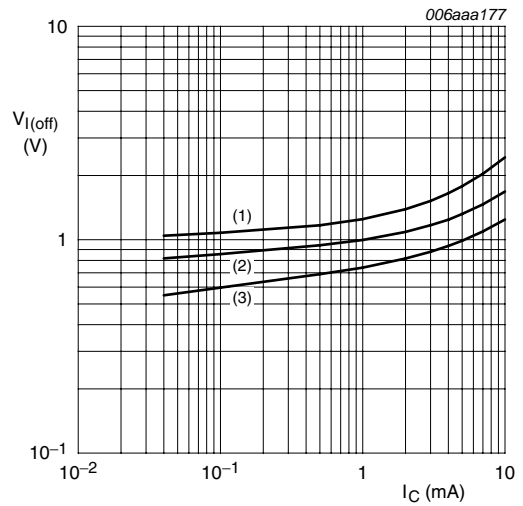

$V_{CE} = 5\text{ V}$
 (1) $T_{amb} = -40\text{ °C}$
 (2) $T_{amb} = 25\text{ °C}$
 (3) $T_{amb} = 100\text{ °C}$

Fig 4. Off-state input voltage as a function of collector current; typical values

8. Package outline

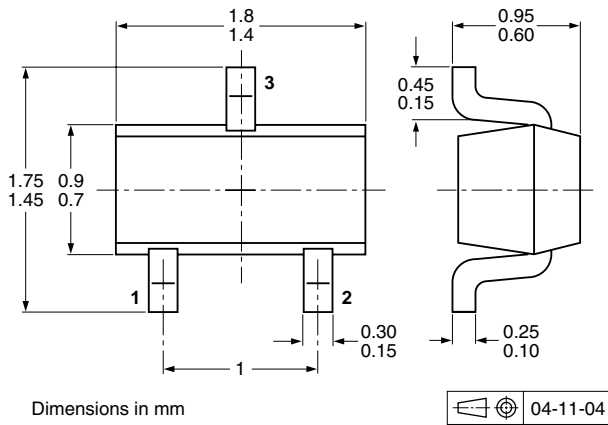

Fig 5. Package outline SOT416 (SC-75)

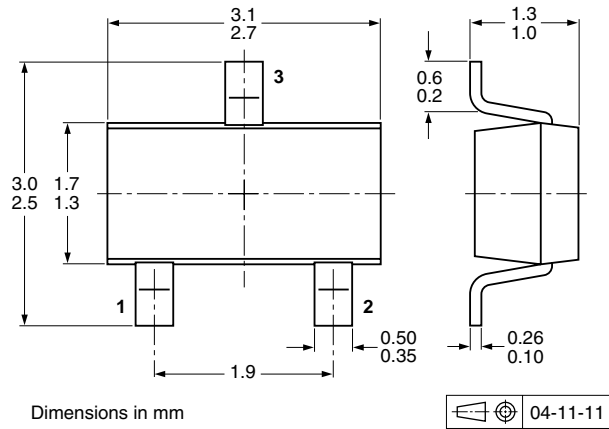

Fig 6. Package outline SOT346 (SC-59A/TO-236)

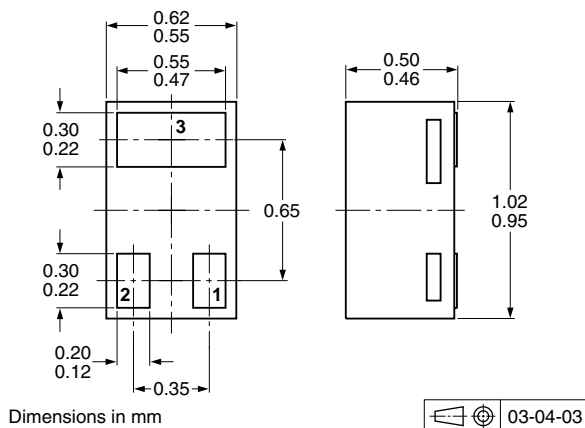

Fig 7. Package outline SOT883 (SC-101)

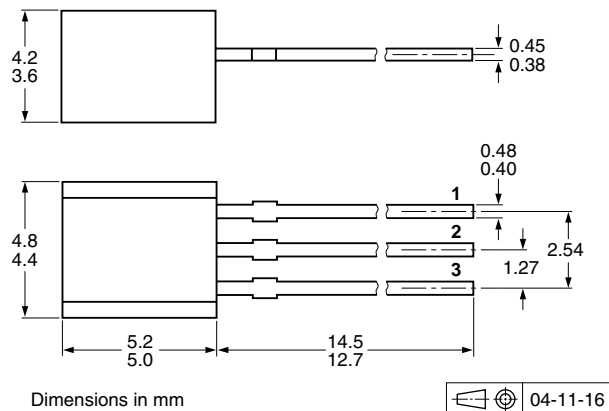

Fig 8. Package outline SOT54 (SC-43A/TO-92)

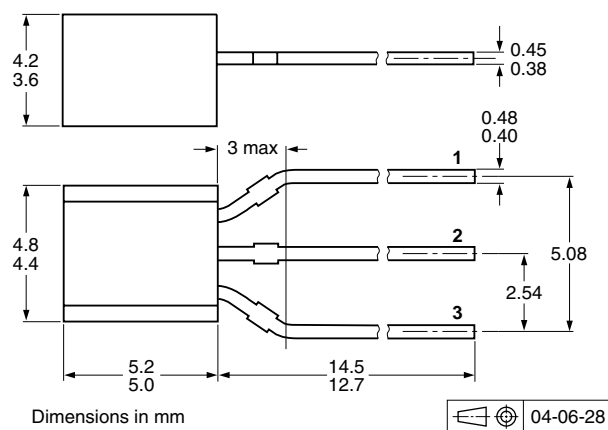

Fig 9. Package outline SOT54A

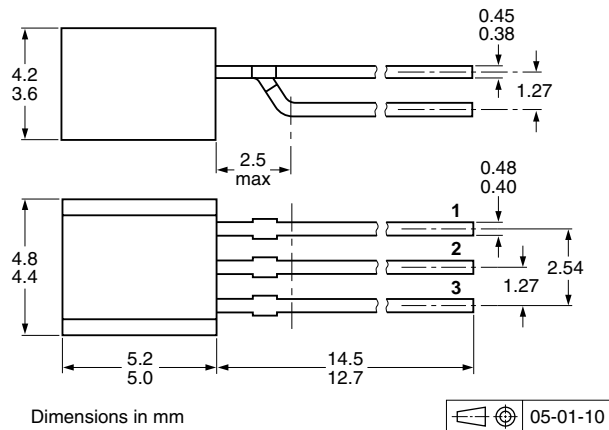

Fig 10. Package outline SOT54 variant

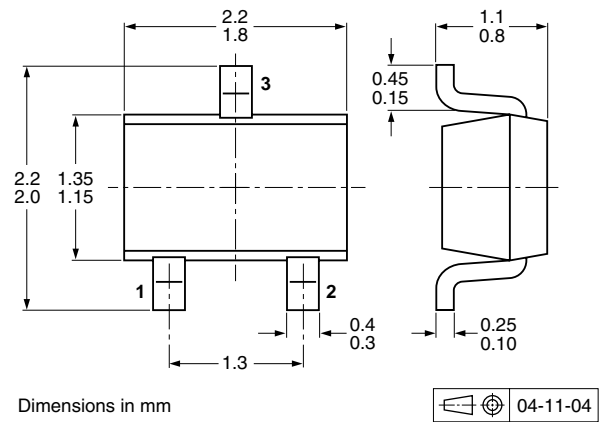
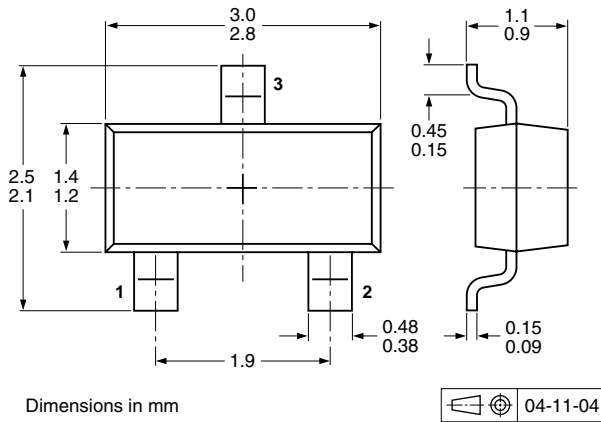

Fig 11. Package outline SOT23 (TO-236AB)

Fig 12. Package outline SOT323 (SC-70)

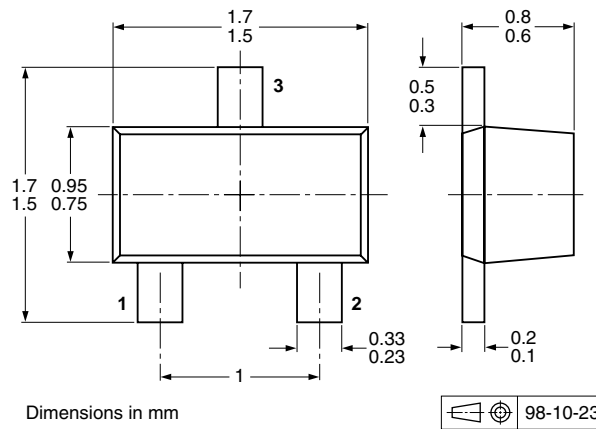

Fig 13. Package outline SOT490 (SC-89)

9. Packing information

Table 9. Packing methods

The indicated -xxx are the last three digits of the 12NC ordering code.^[1]

Type number	Package	Description	Packing quantity			
			3000	4000	5000	10000
PDTC124XE	SOT416	4 mm pitch, 8 mm tape and reel	-115	-	-	-135
PDTC124XEF	SOT490	4 mm pitch, 8 mm tape and reel	-	-115	-	-
PDTC124XK	SOT346	4 mm pitch, 8 mm tape and reel	-115	-	-	-135
PDTC124XM	SOT883	2 mm pitch, 8 mm tape and reel	-	-	-	-315
PDTC124XS	SOT54	bulk, straight leads	-	-	-412	-
	SOT54A	tape and reel, wide pitch	-	-	-	-116
		tape ammopack, wide pitch	-	-	-	-126
	SOT54 variant	bulk, delta pinning	-	-	-112	-
PDTC124XT	SOT23	4 mm pitch, 8 mm tape and reel	-215	-	-	-235
PDTC124XU	SOT323	4 mm pitch, 8 mm tape and reel	-115	-	-	-135

[1] For further information and the availability of packing methods, see [Section 12](#).

10. Revision history

Table 10. Revision history

Document ID	Release date	Data sheet status	Change notice	Supersedes
PDTC124X_SER_7	20091116	Product data sheet	-	PDTC124X_SER_6
Modifications:	<ul style="list-style-type: none"> This data sheet was changed to reflect the new company name NXP Semiconductors, including new legal definitions and disclaimers. No changes were made to the technical content. 			
PDTC124X_SER_6	20050714	Product data sheet	-	PDTC124X_SERIES_5
PDTC124X_SERIES_5	20040813	Product specification	-	PDTC124X_SERIES_4
PDTC124X_SERIES_4	20030410	Product specification	-	PDTC124XEF_2 PDTC124XE_3
PDTC124XE_3	19990518	Product specification	-	PDTC124XE_2
PDTC124XE_2	19980921	Product specification	-	PDTC124XE_1
PDTC124XE_1	19971215	Product specification	-	-
PDTC124XEF_2	19990518	Preliminary specification	-	PDTC124XEF_1
PDTC124XEF_1	19981111	Preliminary specification	-	-

11. Legal information

11.1 Data sheet status

Document status ^{[1][2]}	Product status ^[3]	Definition
Objective [short] data sheet	Development	This document contains data from the objective specification for product development.
Preliminary [short] data sheet	Qualification	This document contains data from the preliminary specification.
Product [short] data sheet	Production	This document contains the product specification.

[1] Please consult the most recently issued document before initiating or completing a design.

[2] The term 'short data sheet' is explained in section "Definitions".

[3] The product status of device(s) described in this document may have changed since this document was published and may differ in case of multiple devices. The latest product status information is available on the Internet at URL <http://www.nxp.com>.

11.2 Definitions

Draft — The document is a draft version only. The content is still under internal review and subject to formal approval, which may result in modifications or additions. NXP Semiconductors does not give any representations or warranties as to the accuracy or completeness of information included herein and shall have no liability for the consequences of use of such information.

Short data sheet — A short data sheet is an extract from a full data sheet with the same product type number(s) and title. A short data sheet is intended for quick reference only and should not be relied upon to contain detailed and full information. For detailed and full information see the relevant full data sheet, which is available on request via the local NXP Semiconductors sales office. In case of any inconsistency or conflict with the short data sheet, the full data sheet shall prevail.

11.3 Disclaimers

General — Information in this document is believed to be accurate and reliable. However, NXP Semiconductors does not give any representations or warranties, expressed or implied, as to the accuracy or completeness of such information and shall have no liability for the consequences of use of such information.

Right to make changes — NXP Semiconductors reserves the right to make changes to information published in this document, including without limitation specifications and product descriptions, at any time and without notice. This document supersedes and replaces all information supplied prior to the publication hereof.

Suitability for use — NXP Semiconductors products are not designed, authorized or warranted to be suitable for use in medical, military, aircraft, space or life support equipment, nor in applications where failure or malfunction of an NXP Semiconductors product can reasonably be expected to result in personal injury, death or severe property or environmental

damage. NXP Semiconductors accepts no liability for inclusion and/or use of NXP Semiconductors products in such equipment or applications and therefore such inclusion and/or use is at the customer's own risk.

Applications — Applications that are described herein for any of these products are for illustrative purposes only. NXP Semiconductors makes no representation or warranty that such applications will be suitable for the specified use without further testing or modification.

Limiting values — Stress above one or more limiting values (as defined in the Absolute Maximum Ratings System of IEC 60134) may cause permanent damage to the device. Limiting values are stress ratings only and operation of the device at these or any other conditions above those given in the Characteristics sections of this document is not implied. Exposure to limiting values for extended periods may affect device reliability.

Terms and conditions of sale — NXP Semiconductors products are sold subject to the general terms and conditions of commercial sale, as published at <http://www.nxp.com/profile/terms>, including those pertaining to warranty, intellectual property rights infringement and limitation of liability, unless explicitly otherwise agreed to in writing by NXP Semiconductors. In case of any inconsistency or conflict between information in this document and such terms and conditions, the latter will prevail.

No offer to sell or license — Nothing in this document may be interpreted or construed as an offer to sell products that is open for acceptance or the grant, conveyance or implication of any license under any copyrights, patents or other industrial or intellectual property rights.

Export control — This document as well as the item(s) described herein may be subject to export control regulations. Export might require a prior authorization from national authorities.

Quick reference data — The Quick reference data is an extract of the product data given in the Limiting values and Characteristics sections of this document, and as such is not complete, exhaustive or legally binding.

11.4 Trademarks

Notice: All referenced brands, product names, service names and trademarks are the property of their respective owners.

12. Contact information

For more information, please visit: <http://www.nxp.com>

For sales office addresses, please send an email to: salesaddresses@nxp.com

13. Contents

1 Product profile 1

1.1 General description 1

1.2 Features 1

1.3 Applications 1

1.4 Quick reference data 1

2 Pinning information 2

3 Ordering information 3

4 Marking 3

5 Limiting values 4

6 Thermal characteristics 5

7 Characteristics 5

8 Package outline 7

9 Packing information 9

10 Revision history 10

11 Legal information 11

11.1 Data sheet status 11

11.2 Definitions 11

11.3 Disclaimers 11

11.4 Trademarks 11

12 Contact information 11

13 Contents 12

Please be aware that important notices concerning this document and the product(s) described herein, have been included in section 'Legal information'.



© NXP B.V. 2009.

All rights reserved.

For more information, please visit: <http://www.nxp.com>



For sales office addresses, please send an email to: salesaddresses@nxp.com

Date of release: 16 November 2009

Document identifier: PDTC124X_SER_7

Looking for pricing, stock, or lifecycle information?

Click below to explore more details on WIN SOURCE:

-  [View PDTC124XE on WIN SOURCE](#)
-  [NXP / Nexperia Information](#)

Optimize Your Supply Chain with WIN SOURCE Solutions

-  Global Sourcing Solution
-  Obsolete Management
-  Cost Control Management
-  Shortage Management
-  Alternative Solution
-  Excess Inventory Management