



THE DATASHEET OF PDTC144VK



Important notice

Dear Customer,

On 7 February 2017 the former NXP Standard Product business became a new company with the tradename **Nexperia**. Nexperia is an industry leading supplier of Discrete, Logic and PowerMOS semiconductors with its focus on the automotive, industrial, computing, consumer and wearable application markets

In data sheets and application notes which still contain NXP or Philips Semiconductors references, use the references to Nexperia, as shown below.

Instead of <http://www.nxp.com>, <http://www.philips.com/> or <http://www.semiconductors.philips.com/>, use <http://www.nexperia.com>

Instead of sales.addresses@www.nxp.com or sales.addresses@www.semiconductors.philips.com, use salesaddresses@nexperia.com (email)

Replace the copyright notice at the bottom of each page or elsewhere in the document, depending on the version, as shown below:

- © NXP N.V. (year). All rights reserved or © Koninklijke Philips Electronics N.V. (year). All rights reserved

Should be replaced with:

- © **Nexperia B.V. (year). All rights reserved.**

If you have any questions related to the data sheet, please contact our nearest sales office via e-mail or telephone (details via salesaddresses@nexperia.com). Thank you for your cooperation and understanding,

Kind regards,

Team Nexperia

PDTC144V series

NPN resistor-equipped transistors; R1 = 47 k Ω , R2 = 10 k Ω

Rev. 04 — 16 November 2009

Product data sheet

1. Product profile

1.1 General description

NPN resistor-equipped transistors.

Table 1. Product overview

| Type number | Package | | PNP complement |
|--------------------------|---------------|--------|----------------|
| | NXP | JEITA | |
| PDTC144VE | SOT416 | SC-75 | PDTA144VE |
| PDTC144VK | SOT346 | SC-59A | PDTA144VK |
| PDTC144VM | SOT883 | SC-101 | PDTA144VM |
| PDTC144VS ^[1] | SOT54 (TO-92) | SC-43A | PDTA144VS |
| PDTC144VT | SOT23 | - | PDTA144VT |
| PDTC144VU | SOT323 | SC-70 | PDTA144VU |

[1] Also available in SOT54A and SOT54 variant packages (see [Section 2](#)).

1.2 Features

- Built-in bias resistors
- Reduces component count
- Simplifies circuit design
- Reduces pick and place costs

1.3 Applications

- General-purpose switching and amplification
- Circuit drivers
- Inverter and interface circuits

1.4 Quick reference data

Table 2. Quick reference data

| Symbol | Parameter | Conditions | Min | Typ | Max | Unit |
|------------------|---------------------------|------------|------|------|------|------------|
| V _{CEO} | collector-emitter voltage | open base | - | - | 50 | V |
| I _O | output current (DC) | | - | - | 100 | mA |
| R1 | bias resistor 1 (input) | | 33 | 47 | 61 | k Ω |
| R2/R1 | bias resistor ratio | | 0.17 | 0.21 | 0.26 | |

2. Pinning information

Table 3. Pinning

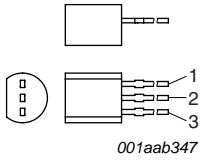
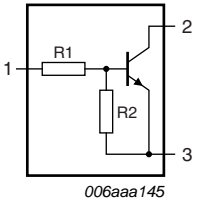
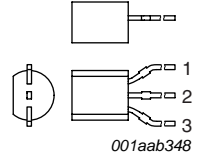
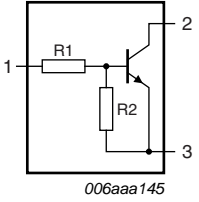
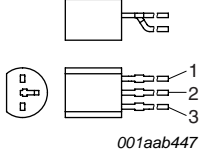
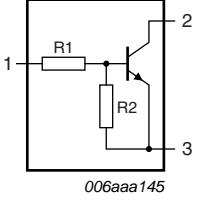
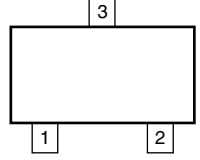
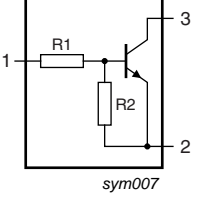
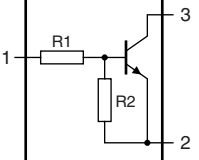
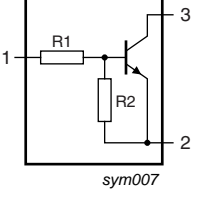
| Pin | Description | Simplified outline | Symbol |
|--------------------------------------|--------------------|---|--|
| SOT54 | | | |
| 1 | input (base) |  <p>001aab347</p> |  <p>006aaa145</p> |
| 2 | output (collector) | | |
| 3 | GND (emitter) | | |
| SOT54A | | | |
| 1 | input (base) |  <p>001aab348</p> |  <p>006aaa145</p> |
| 2 | output (collector) | | |
| 3 | GND (emitter) | | |
| SOT54 variant | | | |
| 1 | input (base) |  <p>001aab447</p> |  <p>006aaa145</p> |
| 2 | output (collector) | | |
| 3 | GND (emitter) | | |
| SOT23, SOT323, SOT346, SOT416 | | | |
| 1 | input (base) |  <p>006aaa144</p> |  <p>sym007</p> |
| 2 | GND (emitter) | | |
| 3 | output (collector) | | |
| SOT883 | | | |
| 1 | input (base) |  <p>sym007</p> |  <p>sym007</p> |
| 2 | GND (emitter) | | |
| 3 | output (collector) | | |

3. Ordering information

Table 4. Ordering information

| Type number | Package | | |
|--------------------------|---------|---|---------|
| | Name | Description | Version |
| PDTC144VE | SC-75 | plastic surface mounted package; 3 leads | SOT416 |
| PDTC144VK | SC-59A | plastic surface mounted package; 3 leads | SOT346 |
| PDTC144VM | SC-101 | leadless ultra small plastic package; 3 solder lands; body 1.0 × 0.6 × 0.5 mm | SOT883 |
| PDTC144VS ^[1] | SC-43A | plastic single-ended leaded (through hole) package; 3 leads | SOT54 |
| PDTC144VT | - | plastic surface mounted package; 3 leads | SOT23 |
| PDTC144VU | SC-70 | plastic surface mounted package; 3 leads | SOT323 |

[1] Also available in SOT54A and SOT54 variant packages (see [Section 2](#) and [Section 9](#)).

4. Marking

Table 5. Marking codes

| Type number | Marking code ^[1] |
|-------------|-----------------------------|
| PDTC144VE | 18 |
| PDTC144VK | 29 |
| PDTC144VM | G6 |
| PDTC144VS | TC144V |
| PDTC144VT | *AA |
| PDTC144VU | *18 |

[1] * = -: made in Hong Kong
 * = p: made in Hong Kong
 * = t: made in Malaysia
 * = W: made in China

5. Limiting values

Table 6. Limiting values

In accordance with the Absolute Maximum Rating System (IEC 60134).

| Symbol | Parameter | Conditions | Min | Max | Unit |
|------------------|---------------------------|--------------------------|----------|------|------|
| V _{CBO} | collector-base voltage | open emitter | - | 50 | V |
| V _{CEO} | collector-emitter voltage | open base | - | 50 | V |
| V _{EBO} | emitter-base voltage | open collector | - | 15 | V |
| V _I | input voltage | | | | |
| | positive | | - | +40 | V |
| | negative | | - | -15 | V |
| I _O | output current (DC) | | - | 100 | mA |
| I _{CM} | peak collector current | | - | 100 | mA |
| P _{tot} | total power dissipation | | | | |
| | SOT416 | T _{amb} ≤ 25 °C | [1] - | 150 | mW |
| | SOT346 | T _{amb} ≤ 25 °C | [1] - | 250 | mW |
| | SOT883 | T _{amb} ≤ 25 °C | [2][3] - | 250 | mW |
| | SOT54 | T _{amb} ≤ 25 °C | [1] - | 500 | mW |
| | SOT23 | T _{amb} ≤ 25 °C | [1] - | 250 | mW |
| | SOT323 | T _{amb} ≤ 25 °C | [1] - | 200 | mW |
| | T _{stg} | storage temperature | | -65 | +150 |
| T _j | junction temperature | | - | 150 | °C |
| T _{amb} | ambient temperature | | -65 | +150 | °C |

[1] Refer to standard mounting conditions.

[2] Reflow soldering is the only recommended soldering method.

[3] Refer to SOT883 standard mounting conditions; FR4 printed-circuit board with 60 μ m copper strip line.

6. Thermal characteristics

Table 7. Thermal characteristics

| Symbol | Parameter | Conditions | Min | Typ | Max | Unit |
|----------------------|---|-------------|----------|-----|-----|------|
| R _{th(j-a)} | thermal resistance from junction to ambient | in free air | | | | |
| | SOT416 | | [1] - | - | 833 | K/W |
| | SOT346 | | [1] - | - | 500 | K/W |
| | SOT883 | | [2][3] - | - | 500 | K/W |
| | SOT54 | | [1] - | - | 250 | K/W |
| | SOT23 | | [1] - | - | 500 | K/W |
| | SOT323 | | [1] - | - | 625 | K/W |

[1] Refer to standard mounting conditions.

[2] Reflow soldering is the only recommended soldering method.

[3] Refer to SOT883 standard mounting conditions; FR4 printed-circuit board with 60 μ m copper strip line.

7. Characteristics

Table 8. Characteristics

$T_{amb} = 25\text{ }^{\circ}\text{C}$ unless otherwise specified.

| Symbol | Parameter | Conditions | Min | Typ | Max | Unit |
|--------------|--------------------------------------|---|------|------|------|---------------|
| I_{CBO} | collector-base cut-off current | $V_{CB} = 50\text{ V}; I_E = 0\text{ A}$ | - | - | 100 | nA |
| I_{CEO} | collector-emitter cut-off current | $V_{CE} = 30\text{ V}; I_B = 0\text{ A}$ | - | - | 1 | μA |
| | | $V_{CE} = 30\text{ V}; I_B = 0\text{ A}; T_j = 150\text{ }^{\circ}\text{C}$ | - | - | 50 | μA |
| I_{EBO} | emitter-base cut-off current | $V_{EB} = 5\text{ V}; I_C = 0\text{ A}$ | - | - | 150 | μA |
| h_{FE} | DC current gain | $V_{CE} = 5\text{ V}; I_C = 5\text{ mA}$ | 40 | - | - | |
| V_{CEsat} | collector-emitter saturation voltage | $I_C = 10\text{ mA}; I_B = 0.5\text{ mA}$ | - | - | 150 | mV |
| $V_{I(off)}$ | off-state input voltage | $V_{CE} = 5\text{ V}; I_C = 100\text{ }\mu\text{A}$ | - | 3.1 | 1 | V |
| $V_{I(on)}$ | on-state input voltage | $V_{CE} = 300\text{ mV}; I_C = 2\text{ mA}$ | 6 | 3.8 | - | V |
| R1 | bias resistor 1 (input) | | 33 | 47 | 61 | k Ω |
| R2/R1 | bias resistor ratio | | 0.17 | 0.21 | 0.26 | |
| C_c | collector capacitance | $V_{CB} = 10\text{ V}; I_E = i_e = 0\text{ A}; f = 1\text{ MHz}$ | - | - | 2 | pF |

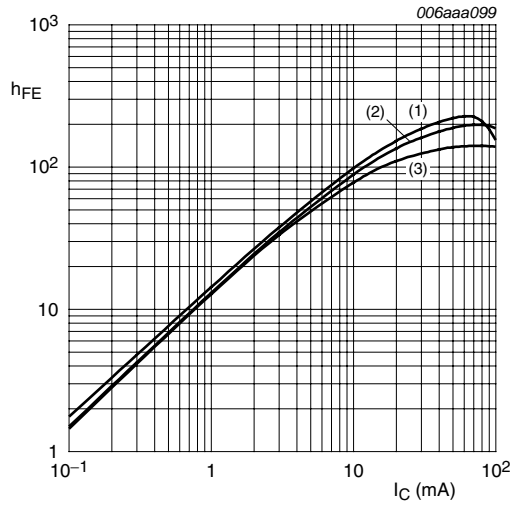

$V_{CE} = 5\text{ V}$
 (1) $T_{amb} = 100\text{ °C}$
 (2) $T_{amb} = 25\text{ °C}$
 (3) $T_{amb} = -40\text{ °C}$

Fig 1. DC current gain as a function of collector current; typical values

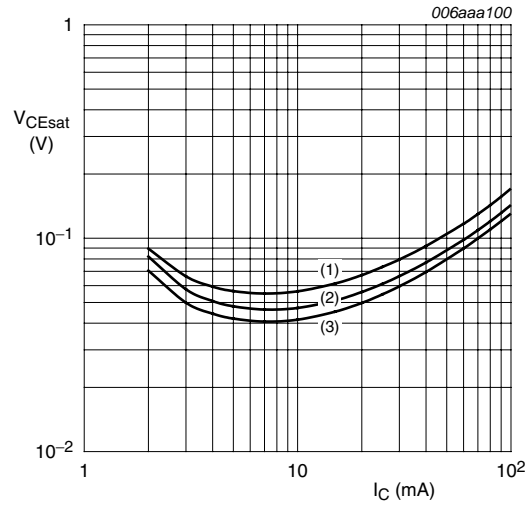

$I_C/I_B = 20$
 (1) $T_{amb} = 100\text{ °C}$
 (2) $T_{amb} = 25\text{ °C}$
 (3) $T_{amb} = -40\text{ °C}$

Fig 2. Collector-emitter saturation voltage as a function of collector current; typical values

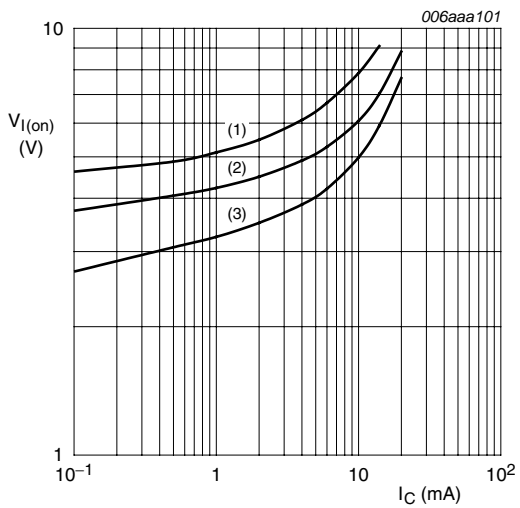

$V_{CE} = 0.3\text{ V}$
 (1) $T_{amb} = -40\text{ °C}$
 (2) $T_{amb} = 25\text{ °C}$
 (3) $T_{amb} = 100\text{ °C}$

Fig 3. On-state input voltage as a function of collector current; typical values

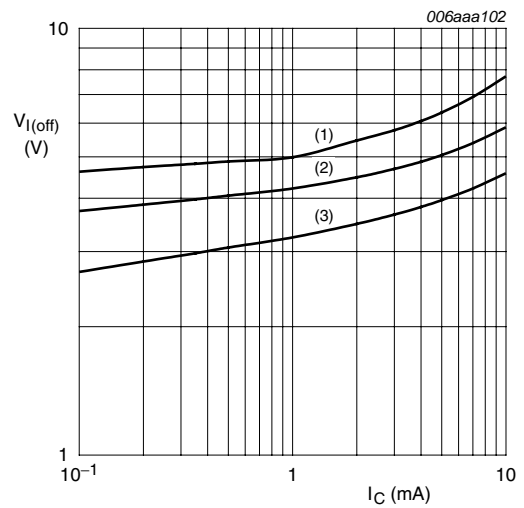

$V_{CE} = 5\text{ V}$
 (1) $T_{amb} = -40\text{ °C}$
 (2) $T_{amb} = 25\text{ °C}$
 (3) $T_{amb} = 100\text{ °C}$

Fig 4. Off-state input voltage as a function of collector current; typical values

8. Package outline

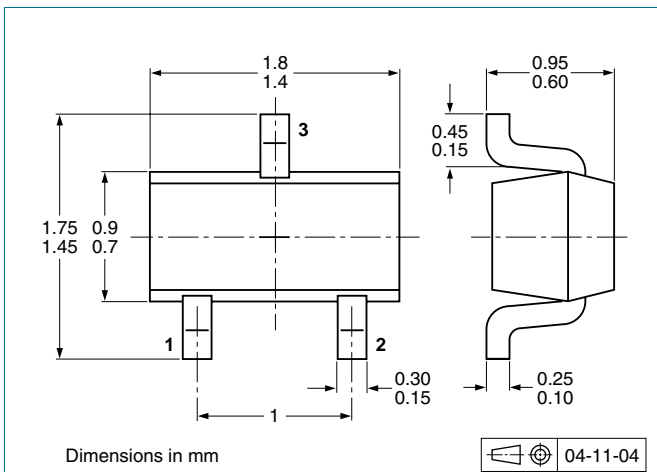

Fig 5. Package outline SOT416 (SC-75)

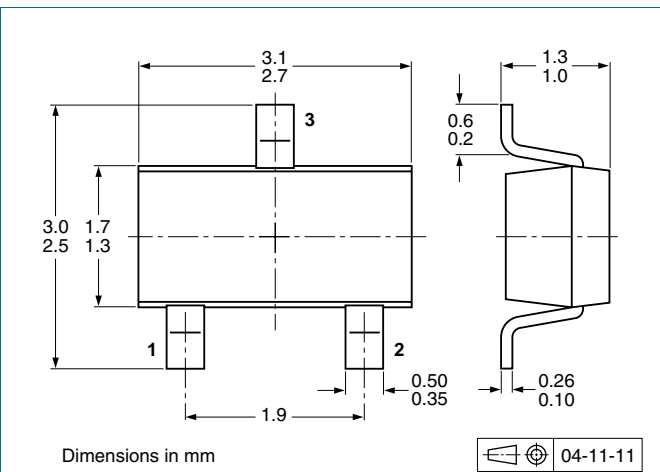

Fig 6. Package outline SOT346 (SC-59A/TO-236)

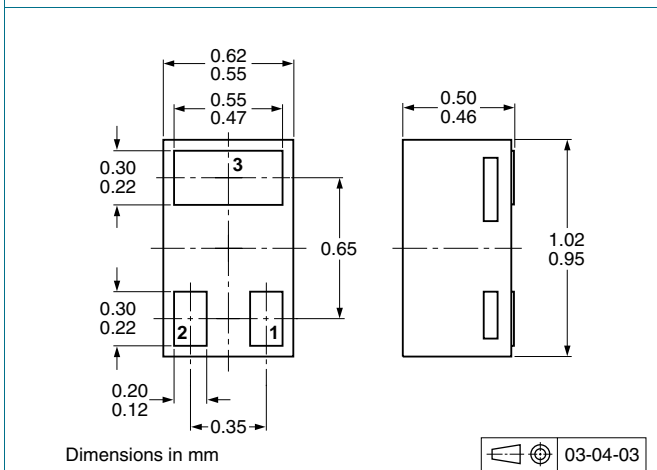

Fig 7. Package outline SOT883 (SC-101)

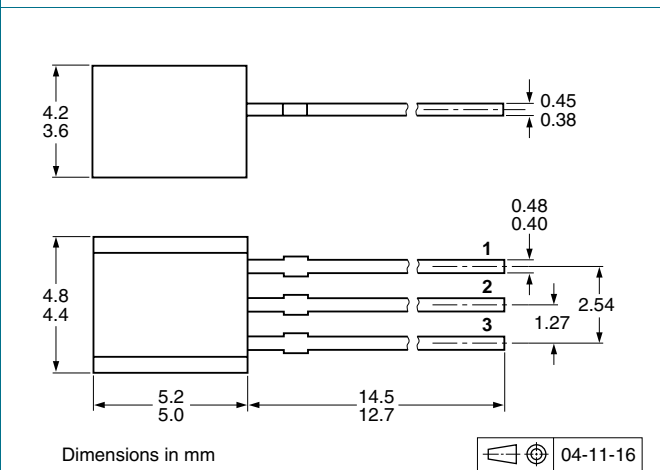

Fig 8. Package outline SOT54 (SC-43A/TO-92)

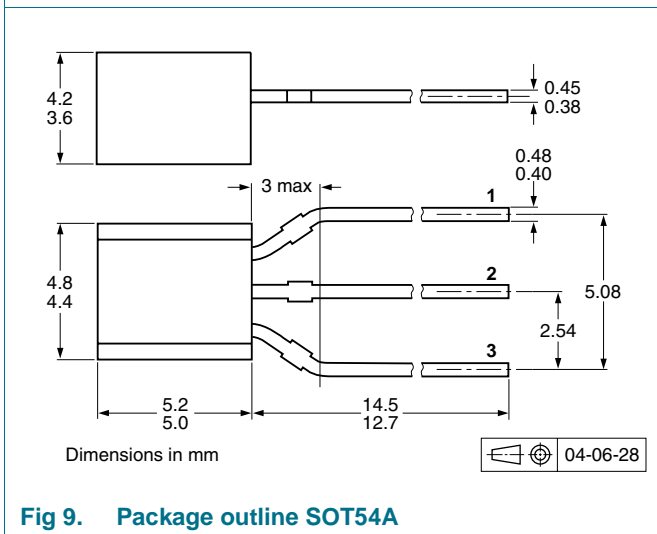

Fig 9. Package outline SOT54A

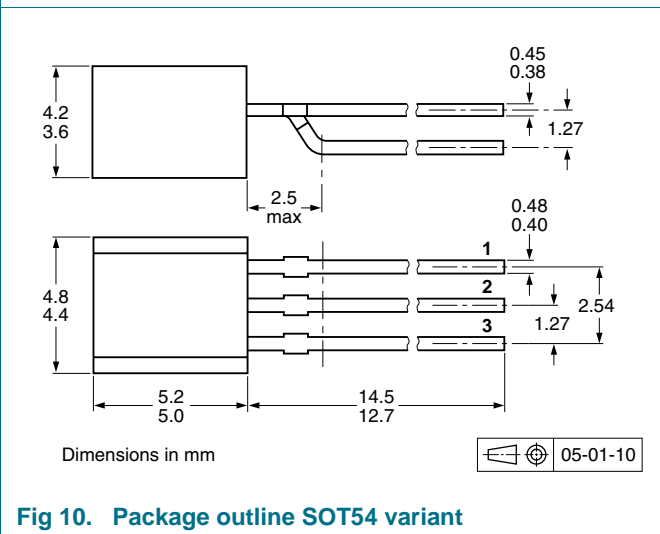
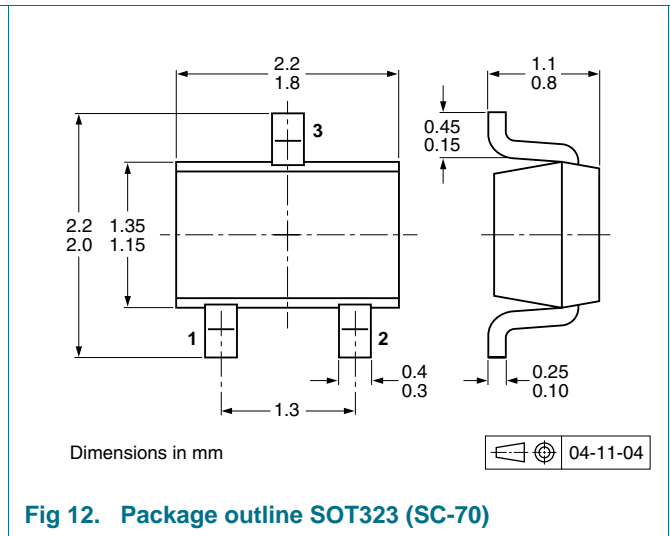
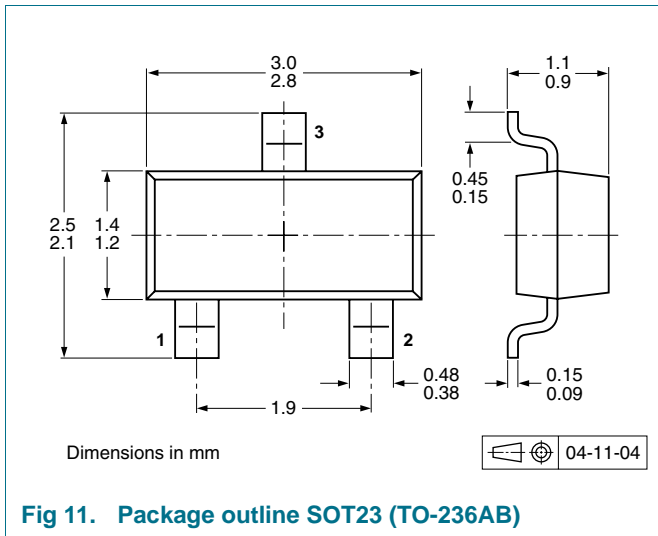

Fig 10. Package outline SOT54 variant



9. Packing information

Table 9. Packing methods

The indicated -xxx are the last three digits of the 12NC ordering code.^[1]

| Type number | Package | Description | Packing quantity | | |
|-------------|---------------|--------------------------------|------------------|------|-------|
| | | | 3000 | 5000 | 10000 |
| PDTC144VE | SOT416 | 4 mm pitch, 8 mm tape and reel | -115 | - | -135 |
| PDTC144VK | SOT346 | 4 mm pitch, 8 mm tape and reel | -115 | - | -135 |
| PDTC144VM | SOT883 | 2 mm pitch, 8 mm tape and reel | - | - | -315 |
| PDTC144VS | SOT54 | bulk, straight leads | - | -412 | - |
| | SOT54A | tape and reel, wide pitch | - | - | -116 |
| | | tape ammopack, wide pitch | - | - | -126 |
| | SOT54 variant | bulk, delta pinning | - | -112 | - |
| PDTC144VT | SOT23 | 4 mm pitch, 8 mm tape and reel | -215 | - | -235 |
| PDTC144VU | SOT323 | 4 mm pitch, 8 mm tape and reel | -115 | - | -135 |

[1] For further information and the availability of packing methods, see [Section 12](#).

10. Revision history

Table 10. Revision history

| Document ID | Release date | Data sheet status | Change notice | Supersedes |
|----------------|---|----------------------|---------------|----------------|
| PDTC144V_SER_4 | 20091116 | Product data sheet | - | PDTC144V_SER_3 |
| Modifications: | <ul style="list-style-type: none">This data sheet was changed to reflect the new company name NXP Semiconductors, including new legal definitions and disclaimers. No changes were made to the technical content. | | | |
| PDTC144V_SER_3 | 20050215 | Product data sheet | - | PDTC144VT_2 |
| PDTC144VT_2 | 20040511 | Objective data sheet | - | PDTC144VT_1 |
| PDTC144VT_1 | 20040305 | Objective data sheet | - | - |

11. Legal information

11.1 Data sheet status

| Document status ^{[1][2]} | Product status ^[3] | Definition |
|-----------------------------------|-------------------------------|---|
| Objective [short] data sheet | Development | This document contains data from the objective specification for product development. |
| Preliminary [short] data sheet | Qualification | This document contains data from the preliminary specification. |
| Product [short] data sheet | Production | This document contains the product specification. |

[1] Please consult the most recently issued document before initiating or completing a design.

[2] The term 'short data sheet' is explained in section "Definitions".

[3] The product status of device(s) described in this document may have changed since this document was published and may differ in case of multiple devices. The latest product status information is available on the Internet at URL <http://www.nxp.com>.

11.2 Definitions

Draft — The document is a draft version only. The content is still under internal review and subject to formal approval, which may result in modifications or additions. NXP Semiconductors does not give any representations or warranties as to the accuracy or completeness of information included herein and shall have no liability for the consequences of use of such information.

Short data sheet — A short data sheet is an extract from a full data sheet with the same product type number(s) and title. A short data sheet is intended for quick reference only and should not be relied upon to contain detailed and full information. For detailed and full information see the relevant full data sheet, which is available on request via the local NXP Semiconductors sales office. In case of any inconsistency or conflict with the short data sheet, the full data sheet shall prevail.

11.3 Disclaimers

General — Information in this document is believed to be accurate and reliable. However, NXP Semiconductors does not give any representations or warranties, expressed or implied, as to the accuracy or completeness of such information and shall have no liability for the consequences of use of such information.

Right to make changes — NXP Semiconductors reserves the right to make changes to information published in this document, including without limitation specifications and product descriptions, at any time and without notice. This document supersedes and replaces all information supplied prior to the publication hereof.

Suitability for use — NXP Semiconductors products are not designed, authorized or warranted to be suitable for use in medical, military, aircraft, space or life support equipment, nor in applications where failure or malfunction of an NXP Semiconductors product can reasonably be expected to result in personal injury, death or severe property or environmental

damage. NXP Semiconductors accepts no liability for inclusion and/or use of NXP Semiconductors products in such equipment or applications and therefore such inclusion and/or use is at the customer's own risk.

Applications — Applications that are described herein for any of these products are for illustrative purposes only. NXP Semiconductors makes no representation or warranty that such applications will be suitable for the specified use without further testing or modification.

Limiting values — Stress above one or more limiting values (as defined in the Absolute Maximum Ratings System of IEC 60134) may cause permanent damage to the device. Limiting values are stress ratings only and operation of the device at these or any other conditions above those given in the Characteristics sections of this document is not implied. Exposure to limiting values for extended periods may affect device reliability.

Terms and conditions of sale — NXP Semiconductors products are sold subject to the general terms and conditions of commercial sale, as published at <http://www.nxp.com/profile/terms>, including those pertaining to warranty, intellectual property rights infringement and limitation of liability, unless explicitly otherwise agreed to in writing by NXP Semiconductors. In case of any inconsistency or conflict between information in this document and such terms and conditions, the latter will prevail.

No offer to sell or license — Nothing in this document may be interpreted or construed as an offer to sell products that is open for acceptance or the grant, conveyance or implication of any license under any copyrights, patents or other industrial or intellectual property rights.

Export control — This document as well as the item(s) described herein may be subject to export control regulations. Export might require a prior authorization from national authorities.

Quick reference data — The Quick reference data is an extract of the product data given in the Limiting values and Characteristics sections of this document, and as such is not complete, exhaustive or legally binding.

11.4 Trademarks

Notice: All referenced brands, product names, service names and trademarks are the property of their respective owners.

12. Contact information

For more information, please visit: <http://www.nxp.com>

For sales office addresses, please send an email to: salesaddresses@nxp.com

13. Contents

1 Product profile 1

1.1 General description 1

1.2 Features 1

1.3 Applications 1

1.4 Quick reference data 1

2 Pinning information 2

3 Ordering information 3

4 Marking 3

5 Limiting values 4

6 Thermal characteristics 4

7 Characteristics 5

8 Package outline 7

9 Packing information 8

10 Revision history 9

11 Legal information 10

11.1 Data sheet status 10

11.2 Definitions 10

11.3 Disclaimers 10

11.4 Trademarks 10

12 Contact information 10

13 Contents 11

Please be aware that important notices concerning this document and the product(s) described herein, have been included in section 'Legal information'.



© NXP B.V. 2009.

All rights reserved.

For more information, please visit: <http://www.nxp.com>



For sales office addresses, please send an email to: salesaddresses@nxp.com

Date of release: 16 November 2009

Document identifier: PDTC144V_SER_4

Looking for pricing, stock, or lifecycle information?

Click below to explore more details on WIN SOURCE:

-  [View PDTC144VK on WIN SOURCE](#)
-  [NXP / Nexperia Information](#)

Optimize Your Supply Chain with WIN SOURCE Solutions

-  Global Sourcing Solution
-  Obsolete Management
-  Cost Control Management
-  Shortage Management
-  Alternative Solution
-  Excess Inventory Management