

16-Bit Bus Transceiver and Register with 3-STATE Outputs
Product Features

- PI74ALVCH16646 is designed for low voltage operation
- $V_{CC} = 2.3V$ to $3.6V$
- Hysteresis on all inputs
- Typical V_{OLP} (Output Ground Bounce) $< 0.8V$ at $V_{CC} = 3.3V, T_A = 25^\circ C$
- Typical V_{OHV} (Output V_{OH} Undershoot) $< 2.0V$ at $V_{CC} = 3.3V, T_A = 25^\circ C$
- Bus Hold retains last active bus state during 3-STATE, eliminating the need for external pullup resistors
- Industrial operation at $-40^\circ C$ to $+85^\circ C$
- Packages available:
 - 56-pin 240 mil wide plastic TSSOP (A)
 - 56-pin 300 mil wide plastic SSOP (V)

Product Description

Pericom Semiconductor's PI74ALVCH series of logic circuits are produced in the Company's advanced 0.5 micron CMOS technology, achieving industry leading speed.

The PI74ALVCH16646 is a 16-bit bus transceiver and register designed for 2.3V to 3.6V V_{CC} operation. It can be used as two 8-bit transceivers or one 16-bit transceiver. Data on the A or B bus is clocked into the registers on the low-to-high transition of the appropriate Clock (CLKAB or CLKBA) input. Four fundamental bus-management functions can be performed.

Output Enable (\overline{OE}) and Direction Control (DIR) inputs are provided to control the transceiver functions. In the transceiver mode, data present at the high-impedance port may be stored in either register or in both. The Select Control (SAB and SBA) inputs can multiplex stored and real-time (transparent mode) data. Circuitry used for Select Control eliminates the typical decoding glitch that occurs in a multiplexer during the transition between stored and real-time data. DIR determines which bus receives data when \overline{OE} is LOW. In the isolation mode (\overline{OE} HIGH), A data may be stored in one register and/or B data may be stored in the other register.

When an output function is disabled, the input function is still enabled and may be used to store and transmit data. Only one of the two buses, A or B, can be driven at a time.

To ensure the high-impedance state during power up or power down, \overline{OE} should be tied to V_{CC} through a pullup resistor; the minimum value of the resistor is determined by the current-sinking capability of the driver.

Active bus-hold circuitry is provided to hold unused or floating data inputs at a valid logic level.

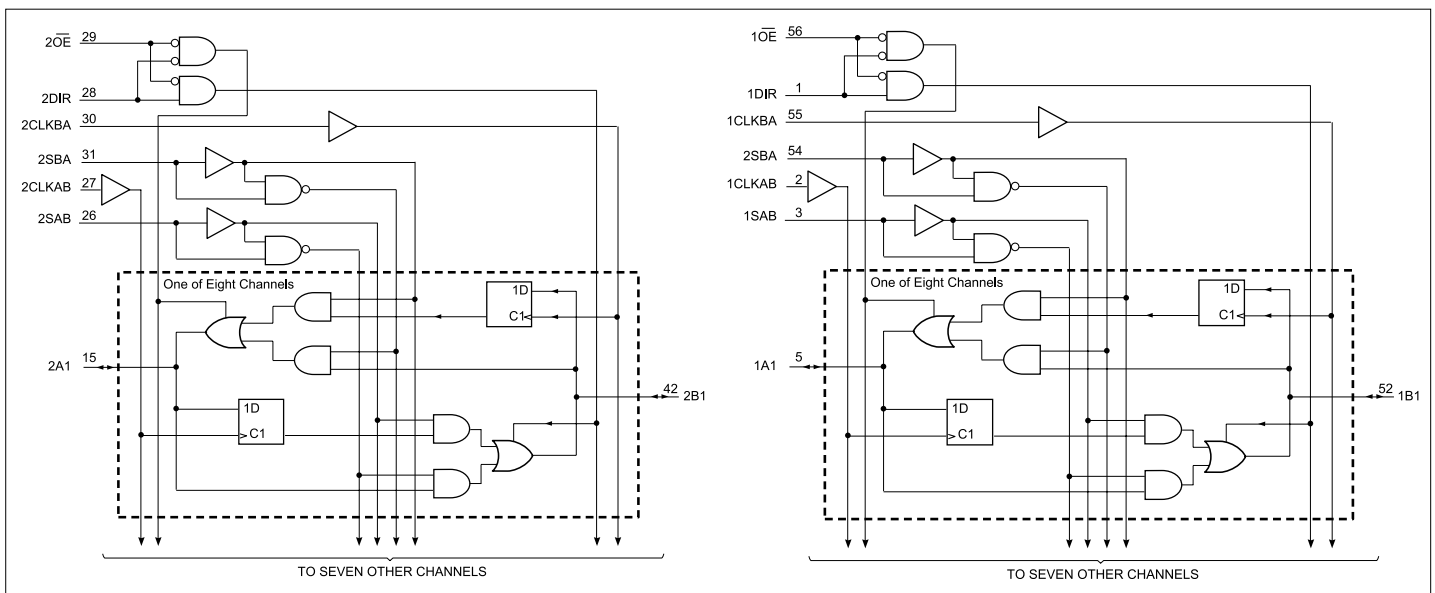
Logic Block Diagram

Product Pin Configuration

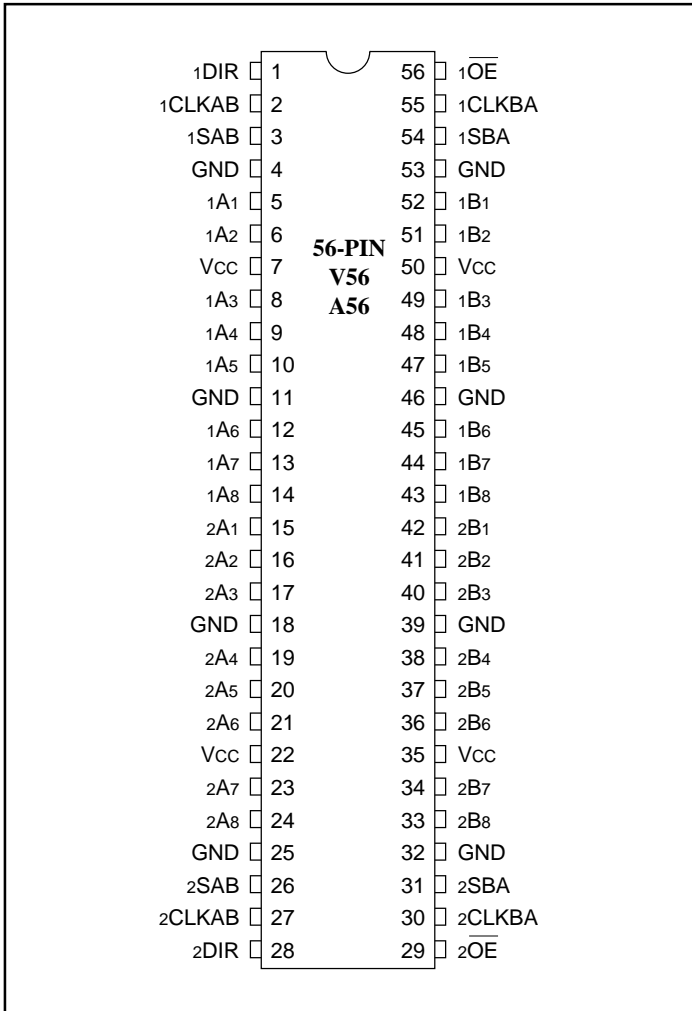

Product Pin Description

Pin Name	Description
\overline{xOE}	Output Enable Inputs (Active LOW)
xDIR	Direction Control
xCLKAB, xCLKBA	Clock Pulse Inputs
xSAB, xSBA	Select Control Inputs
xAx	Data Register A Inputs Data Register B Outputs
xBx	Data Register B Inputs Data Register A Outputs
GND	Ground
VCC	Power

Truth Table⁽²⁾

Function	Inputs						Data I/O	
	\overline{xOE}	xDIR	xCLKAB	xCLKBA	xSAB	xSBA	xAx	xBx
Store A, B Unspecified ⁽¹⁾	X	X	↑	X	X	X	Input	Unspecified ⁽¹⁾
Store B, A Unspecified ⁽¹⁾	X	X	X	↑	X	X	Unspecified ⁽¹⁾	Input
Isolation	H	X	H or L	H or L	X	X	Input Disable	Input Disable
Store A and B Data	H	X	↑	↑	X	X	Input	Input
Real Time A Data to B Bus	L	H	X	X	L	X	Input	Output
Stored A Data to B Bus	L	H	H or L	X	H	X	Input	Output
Real Time B Data to A Bus	L	L	X	X	X	L	Output	Input
Stored B Data to A Bus	L	L	X	H or L	X	H	Output	Input

Note:

1. The data output functions may be enabled or disabled by various signals at the \overline{xOE} or xDIR inputs. Data input functions are always enabled, i.e., data at the bus pins will be stored on every LOW-to-HIGH transition on the clock inputs.
2. H = High Voltage Level
X = Don't Care
L = Low Voltage Level
↑ = LOW-to-HIGH Transition

**REAL-TIME TRANSFER
BUS B TO A**

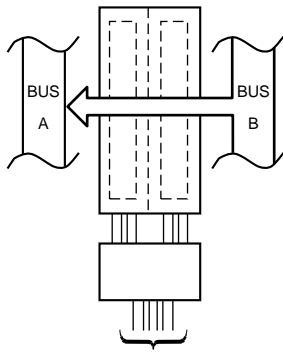

xDIR	$\overline{\text{xOE}}$	xCLKAB	xCLKBA	xSAB	xSBA
L	L	X	X	X	L

**REAL-TIME TRANSFER
BUS A TO B**

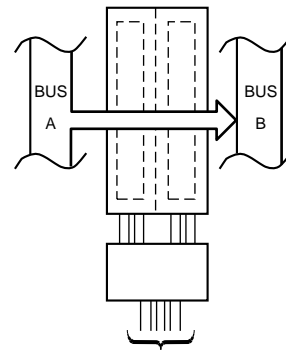

xDIR	$\overline{\text{xOE}}$	xCLKAB	xCLKBA	xSAB	xSBA
H	L	X	X	L	X

**STORAGE FROM
A AND/OR B**

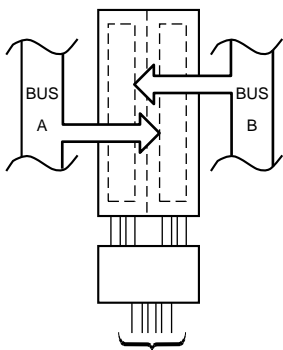

xDIR	$\overline{\text{xOE}}$	xCLKAB	xCLKBA	xSAB	xSBA
X	X	↑	X	X	X
X	X	X	↑	X	X
X	H	↑	↑	X	X

**TRANSFER STORES
DATA TO A AND/OR B**

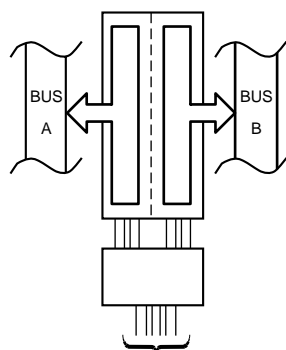

xDIR ⁽¹⁾	$\overline{\text{xOE}}$	xCLKAB	xCLKBA	xSAB	xSBA
L	L	X	H or L	X	H
H	L	H or L	X	H	X

Note:

1. Cannot transfer data to A bus and B bus simultaneously.

Maximum Ratings

(Above which the useful life may be impaired. For user guidelines, not tested.)

Storage Temperature	-65°C to +150°C
Ambient Temperature with Power Applied	-40°C to +85°C
Input Voltage Range, V_{IN}	-0.5V to $V_{CC} + 4.6V$
Output Voltage Range, V_{OUT}	-0.5V to $V_{CC} + 0.5V$
DC Input Voltage	-0.5V to +5.0V
DC Output Current	50 mA
Power Dissipation	1.0W

Note:

Stresses greater than those listed under MAXIMUM RATINGS may cause permanent damage to the device. This is a stress rating only and functional operation of the device at these or any other conditions above those indicated in the operational sections of this specification is not implied. Exposure to absolute maximum rating conditions for extended periods may affect reliability.

DC Electrical Characteristics (Over the Operating Range, $T_A = -40^\circ\text{C}$ to $+85^\circ\text{C}$, $V_{CC} = 3.3V \pm 10\%$)

Parameters	Description	Test Conditions ⁽¹⁾	Min.	Typ. ⁽²⁾	Max.	Units
V_{CC}	Supply Voltage		2.3		3.6	V
$V_{IH}^{(3)}$	Input HIGH Voltage	$V_{CC} = 2.3V$ to $2.7V$	1.7			
		$V_{CC} = 2.7V$ to $3.6V$	2.0			
$V_{IL}^{(3)}$	Input LOW Voltage	$V_{CC} = 2.3V$ to $2.7V$			0.7	
		$V_{CC} = 2.7V$ to $3.6V$			0.8	
$V_{IN}^{(3)}$	Input Voltage		0		V_{CC}	
$V_{OUT}^{(3)}$	Output Voltage		0		V_{CC}	
V_{OH}	Output HIGH Voltage	$I_{OH} = -100\mu\text{A}$, $V_{CC} = \text{Min. to Max.}$	$V_{CC} - 0.2$			
		$V_{IH} = 1.7V$, $I_{OH} = -6\text{mA}$, $V_{CC} = 2.3V$	2.0			
		$V_{IH} = 1.7V$, $I_{OH} = -12\text{mA}$, $V_{CC} = 2.3V$	1.7			
		$V_{IH} = 2.0V$, $I_{OH} = -12\text{mA}$, $V_{CC} = 2.7V$	2.2			
		$V_{IH} = 2.0V$, $I_{OH} = -12\text{mA}$, $V_{CC} = 3.0V$	2.4			
		$V_{IH} = 2.0V$, $I_{OH} = -24\text{mA}$, $V_{CC} = 3.0V$	2.0			
V_{OL}	Output LOW Voltage	$I_{OL} = 100\mu\text{A}$, $V_{IL} = \text{Min. to Max.}$			0.2	
		$V_{IL} = 0.7V$, $I_{OL} = 6\text{mA}$, $V_{CC} = 2.3V$			0.4	
		$V_{IL} = 0.7V$, $I_{OL} = 12\text{mA}$, $V_{CC} = 2.3V$			0.7	
		$V_{IL} = 0.8V$, $I_{OL} = 12\text{mA}$, $V_{CC} = 2.7V$			0.4	
		$V_{IL} = 0.8V$, $I_{OL} = 24\text{mA}$, $V_{CC} = 3.0V$			0.55	
$I_{OH}^{(3)}$	Output HIGH Current	$V_{CC} = 2.3V$			-12	mA
		$V_{CC} = 2.7V$			-12	
		$V_{CC} = 3.0V$			-24	
$I_{OL}^{(3)}$	Output LOW Current	$V_{CC} = 2.3V$			12	
		$V_{CC} = 2.7V$			12	
		$V_{CC} = 3.0V$			24	

DC Electrical Characteristics-Continued (Over the Operating Range, $T_A = -40^{\circ}\text{C}$ to $+85^{\circ}\text{C}$, $V_{CC} = 3.3\text{V} \pm 10\%$)

Parameters	Description	Test Conditions ⁽¹⁾	Min.	Typ. ⁽²⁾	Max.	Units
I_{IN}	Input Current	$V_{IN} = V_{CC}$ or GND, $V_{CC} = 3.6\text{V}$			± 5	μA
$I_{IN (HOLD)}$	Input Hold Current	$V_{IN} = 0.7\text{V}$, $V_{CC} = 2.3\text{V}$	45			
		$V_{IN} = 1.7\text{V}$, $V_{CC} = 2.3\text{V}$	-45			
		$V_{IN} = 0.8\text{V}$, $V_{CC} = 3.0\text{V}$	75			
		$V_{IN} = 2.0\text{V}$, $V_{CC} = 3.0\text{V}$	-75			
		$V_{IN} = 0$ to 3.6V , $V_{CC} = 3.6\text{V}$			± 500	
I_{OZ}	Output Current (3-STATE Outputs)	$V_{OUT} = V_{CC}$ or GND, $V_{CC} = 3.6\text{V}$			± 10	
I_{CC}	Supply Current	$V_{CC} = 3.6\text{V}$, $I_{OUT} = 0\mu\text{A}$, $V_{IN} = \text{GND}$ or V_{CC}			40	
ΔI_{CC}	Supply Current per Input @ TTL HIGH	$V_{CC} = 3.0\text{V}$ to 3.6V One Input at $V_{CC} - 0.6\text{V}$ Other Inputs at V_{CC} or GND			750	
C_I	Control Inputs	$V_{IN} = V_{CC}$ or GND, $V_{CC} = 3.3\text{V}$		3		pF
	Data Inputs			6		
C_O	Outputs	$V_O = V_{CC}$ or GND, $V_{CC} = 3.3\text{V}$		7		

Notes:

1. For conditions shown as Max. or Min., use appropriate value specified under Electrical Characteristics for the applicable device type.
2. Typical values are at $V_{CC} = 3.3\text{V}$, $+25^{\circ}\text{C}$ ambient and maximum loading.
3. Unused Control Inputs must be held HIGH or LOW to prevent them from floating.

Timing Requirements

Parameters	Description		Conditions ⁽¹⁾	$V_{CC} = 2.5\text{V} \pm 0.2\text{V}$		$V_{CC} = 2.7\text{V}$		$V_{CC} = 3.3\text{V} \pm 0.3\text{V}$		Units
				Min. ⁽²⁾	Max.	Min. ⁽²⁾	Max.	Min. ⁽²⁾	Max.	
F_{CLOCK}	Clock Frequency		$C_L = 50\text{pF}$ $R_L = 500\Omega$	0	150	0	150	0	150	MHz
t_W	Pulse Duration	CLKAB or CLKBA HIGH or LOW		3.3		3.3		3.3		ns
t_{SU}	Setup Time	A Before CLKAB \uparrow or B Before CLKBA \uparrow		1.6		1.7		1.4		
t_H	Hold Time	A After CLKAB \uparrow or B After CLKBA \uparrow		0.6		0.4		0.7		

Switching Characteristics over Operating Range⁽¹⁾

Parameters	From (INPUT)	To (OUTPUT)	Conditions ⁽¹⁾	V _{CC} = 2.5V ±0.2V		V _{CC} = 2.7V		V _{CC} = 3.3V ±0.3V		Units		
				Min. ⁽²⁾	Max.	Min. ⁽²⁾	Max.	Min. ⁽²⁾	Max.			
f _{MAX}			C _L = 50pF R _L = 500Ω	150		150		150		MHz		
t _{PD}	A or B	B or A		1.0		4.8		4.5	1.0		ns	
t _{PD}	CLKAB or CLKBA	A or B				5.6		5.2				3.9
t _{PD}	SAB or SBA					6.8		6.4				4.5
t _{EN}	OE					6.5		6.2				5.1
t _{DIS}	OE	A or B		1.8	5.7		5.0	1.4	4.7			
t _{EN}	DIR			1.0	7.8		6.2	1.0	5.1			
t _{DIS}	DIR			1.7	6.5		6.0	1.1	5.3			
Description												
Δt/Δv ⁽³⁾	Input Transition Rise or Fall			0	10	0	10	0	10	ns/V		

Notes:



1. See test circuit and waveforms.
2. Minimum limits are guaranteed but not tested on Propagation Delays.
3. Recommended operating condition.

Operating Characteristics, T_A = 25°C

Parameter		Test Conditions	V _{CC} = 2.5V ±0.2V	V _{CC} = 3.3V ±0.3V	Units
			Typ.		
CPD Power Dissipation Capacitance	Outputs Enabled	C _L = 50pF, f = 10 MHz	39	43	pF
	Outputs Disabled		10	12	

Looking for pricing, stock, or lifecycle information?

Click below to explore more details on WIN SOURCE:

-  [View PI74ALVCH16646A on WIN SOURCE](#)
-  [Diodes Incorporated Information](#)

Optimize Your Supply Chain with WIN SOURCE Solutions

-  Global Sourcing Solution
-  Obsolete Management
-  Cost Control Management
-  Shortage Management
-  Alternative Solution
-  Excess Inventory Management