28/40/44-Pin, 8-Bit CMOS Flash Microcontroller Product Brief

High-Performance RISC CPU:

- Only 35 instructions to learn:
 - All single-cycle instructions except branches
- Operating speed:
 - DC – 20 MHz oscillator/clock input
 - DC – 200 ns instruction cycle
- Up to 8K x 14 words of Flash Program Memory
- Up to 368 bytes of data memory (RAM)
- Interrupt capability
- 8-level deep hardware stack
- Direct, Indirect and Relative Addressing modes
- Processor read access to program memory
- Pinout compatible to other 28/40-pin PIC16CXXX and PIC16FXXX microcontrollers

Special Microcontroller Features:

- Precision Internal Oscillator:
 - 16 MHz or 500 kHz operation
 - Factory calibrated to $\pm 1\%$, typical
 - Software tunable
 - Software selectable $\div 1$, $\div 2$, $\div 4$ or $\div 8$ divider
- Power-Saving Sleep mode
- Industrial and Extended temperature range
- Power-on Reset (POR)
- Power-up Timer (PWRT) and Oscillator Start-up Timer (OST)
- Brown-out Reset (BOR)
 - Selectable between two trip points
 - Disable in Sleep option
- Multiplexed Master Clear with pull-up/input pin
- Programmable code protection
- High-Endurance Flash cell:
 - 10,000 write Flash endurance (typical)
 - Flash retention: > 40 years
- Wide operating voltage range (1.8V-5.5V)
- On chip 3.2V Regulator
 - External capacitor pin can be used as I/O in lower voltage (1.8V-3.6V) applications.

Low-Power Features:

- Standby Current:
 - 100 nA @ 2.0V, typical
- Operating Current:
 - 6.0 μ A @ 32 kHz, 2.0V, typical
 - 54 μ A @ 1 MHz, 2.0V, typical
- Low-Power Watchdog Timer Current:
 - 1.0 μ A @ 2.0V, typical

Peripheral Features:

- Up to 35 I/O pins and 1 input-only pin:
 - High-current source/sink for direct LED drive
 - Interrupt-on-pin change
 - Individually programmable weak pull-ups
- In-Circuit Serial Programming™ (ICSP™) via two pins
- A/D Converter:
 - 8-bit resolution and up to 14 channels
 - Can operate during Sleep
 - Selectable 1.024/2.048/4.096V voltage reference
- Timer0: 8-bit timer/counter with 8-bit programmable prescaler
- Enhanced Timer1
 - Dedicated low-power 32 kHz oscillator
 - 16-bit timer/counter with prescaler
 - External Gate Input mode with toggle and single shot modes
 - Interrupt on gate completion
- Timer2: 8-bit timer/counter with 8-bit period register, prescaler and postscaler
- Two Capture, Compare, PWM modules
 - 16-bit Capture, max. resolution 12.5 ns
 - 16-bit Compare, max. resolution 200 ns
 - 10-bit PWM, max. frequency 20 kHz
- Addressable Universal Synchronous Asynchronous Receiver Transmitter (AUSART)
- Synchronous Serial Port (SSP)
 - SPI (Master/Slave)
 - I²C™ (Slave) with Address Mask

PIC16F72X

Device	Program Memory Flash (words)	SRAM (bytes)	I/Os	Interrupts	8-bit A/D (ch)	AUSART	CCP	Timers 8/16-bit
PIC16F722	2048	128	25	12	11	Yes	2	2/1
PIC16F723	4096	192	25	12	11	Yes	2	2/1
PIC16F724	4096	192	36	12	14	Yes	2	2/1
PIC16F726	8192	368	25	12	11	Yes	2	2/1
PIC16F727	8192	368	36	12	14	Yes	2	2/1

FIGURE 1: 28-PIN PDIP/SOIC/SSOP DIAGRAM FOR PIC16F722/723/726

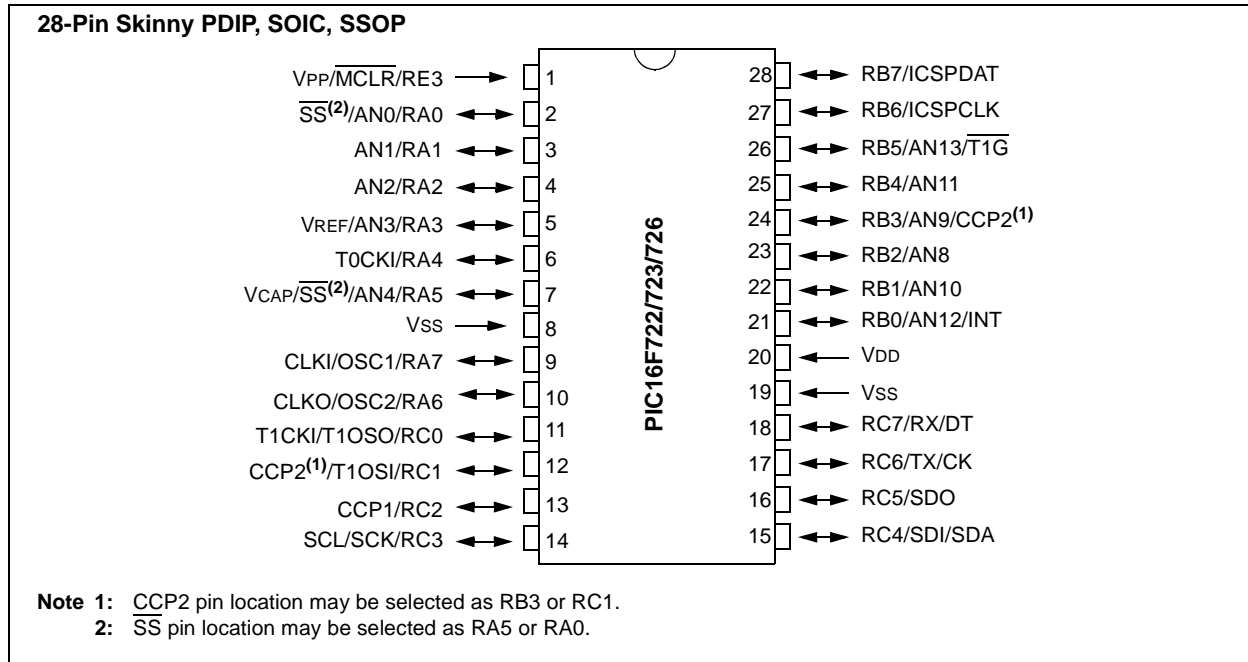
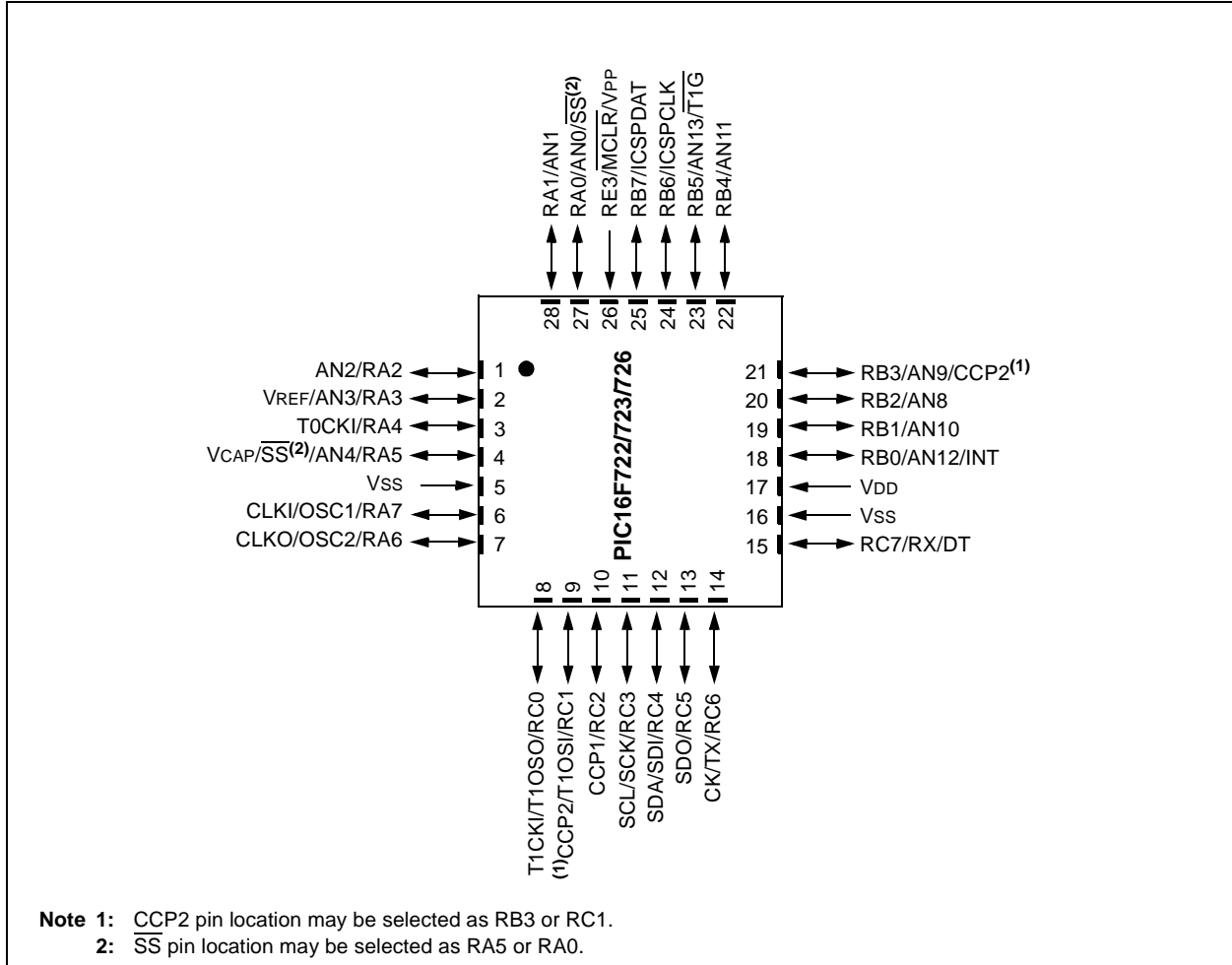

FIGURE 2: 28-PIN QFN (6X6 MM) PACKAGE DIAGRAM FOR PIC16F722/723/726



PIC16F72X

FIGURE 3: 40-PIN PDIP PACKAGE DIAGRAM FOR PIC16F724/727

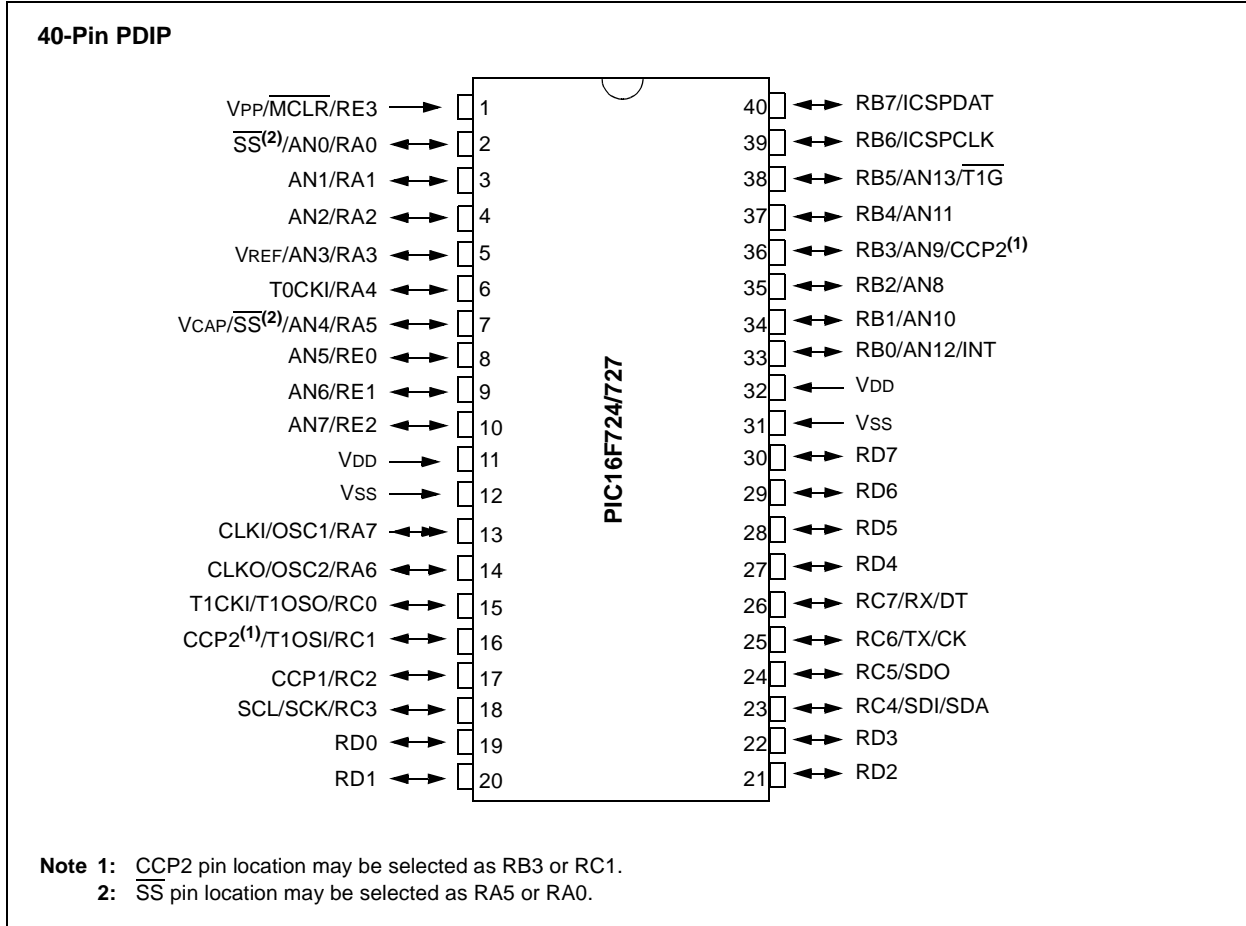
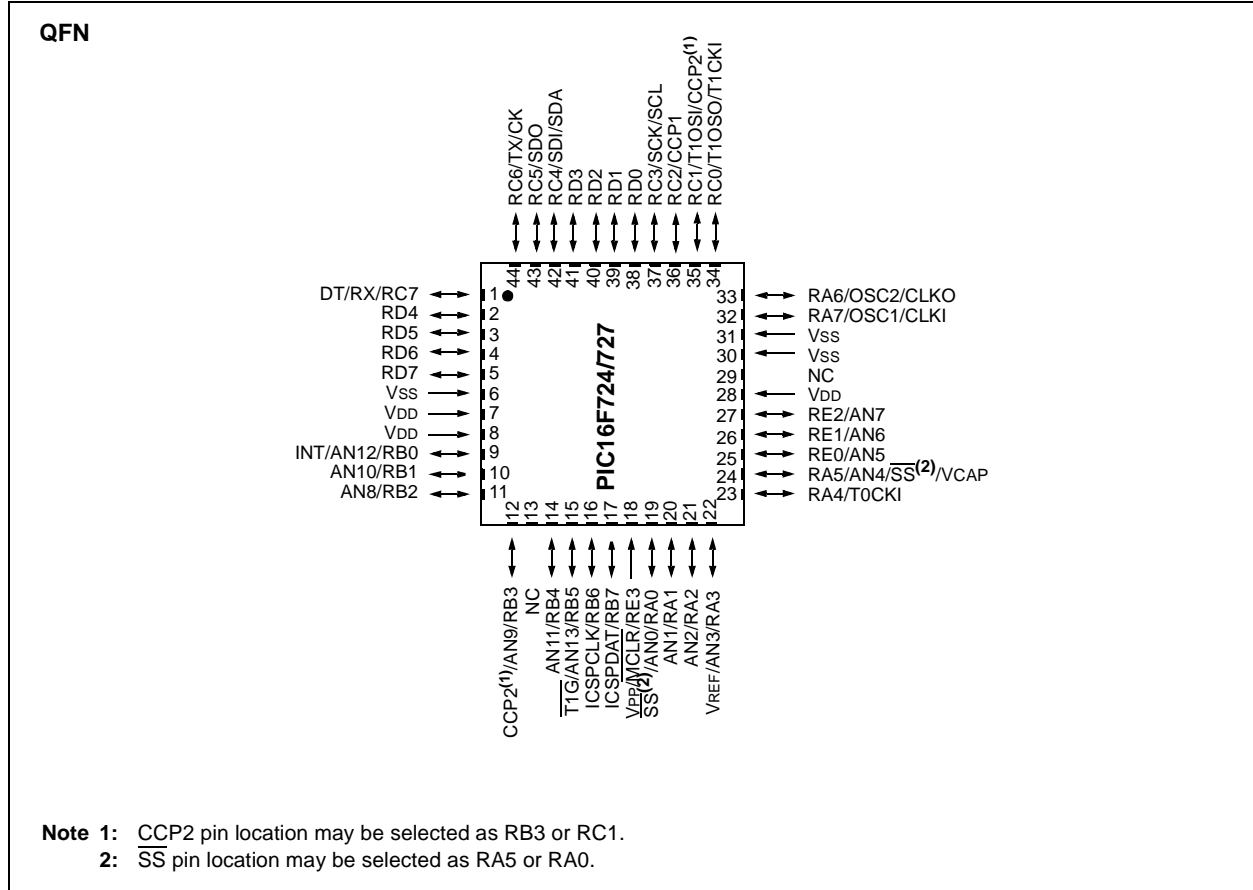
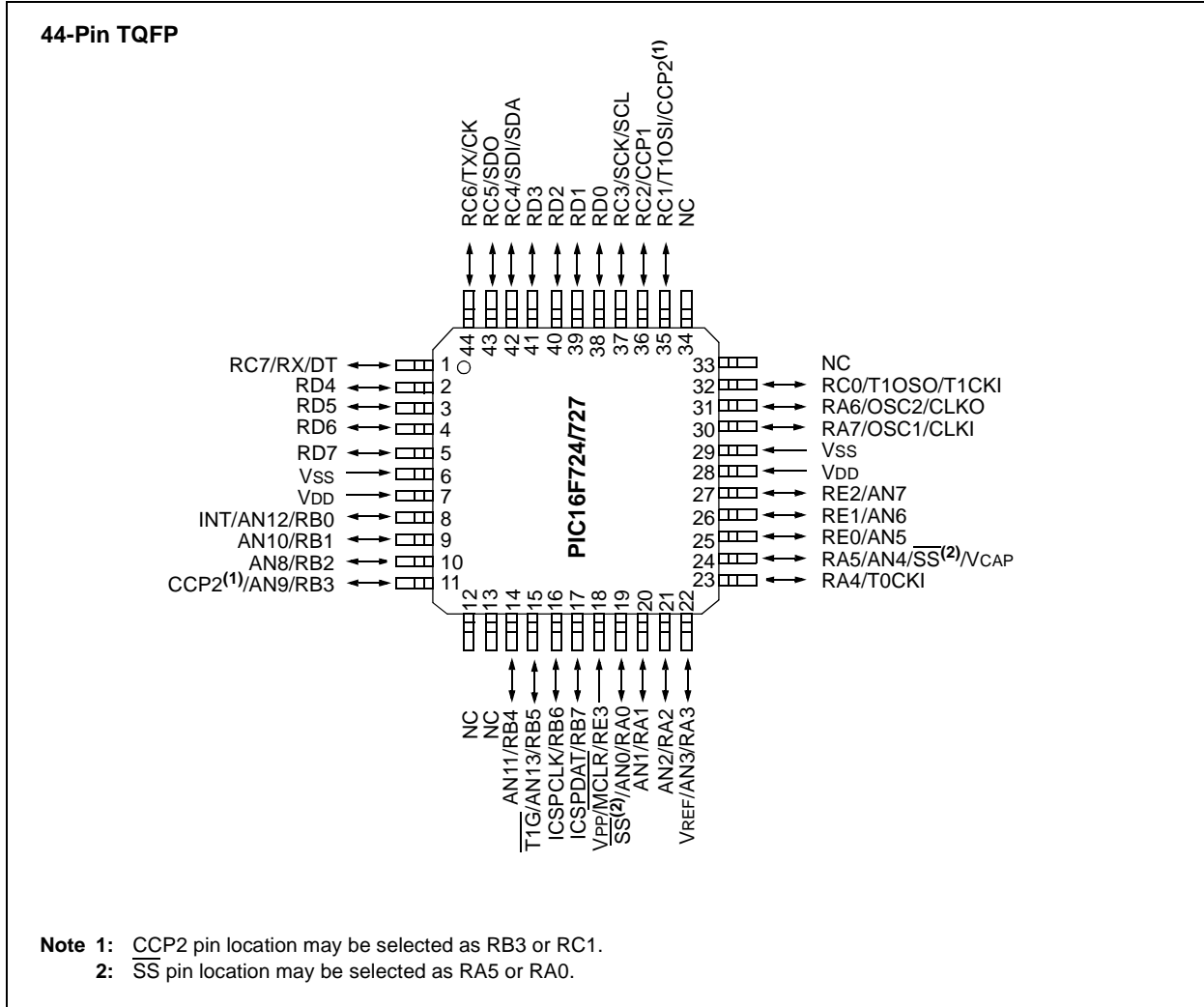

FIGURE 4: 44-PIN QFN (8X8 MM) PACKAGE DIAGRAM FOR PIC16F724/727



PIC16F72X

FIGURE 5: 44-PIN TQFP PACKAGE DIAGRAM FOR PIC16F724/727



Note the following details of the code protection feature on Microchip devices:

- Microchip products meet the specification contained in their particular Microchip Data Sheet.
- Microchip believes that its family of products is one of the most secure families of its kind on the market today, when used in the intended manner and under normal conditions.
- There are dishonest and possibly illegal methods used to breach the code protection feature. All of these methods, to our knowledge, require using the Microchip products in a manner outside the operating specifications contained in Microchip's Data Sheets. Most likely, the person doing so is engaged in theft of intellectual property.
- Microchip is willing to work with the customer who is concerned about the integrity of their code.
- Neither Microchip nor any other semiconductor manufacturer can guarantee the security of their code. Code protection does not mean that we are guaranteeing the product as “unbreakable.”

Code protection is constantly evolving. We at Microchip are committed to continuously improving the code protection features of our products. Attempts to break Microchip's code protection feature may be a violation of the Digital Millennium Copyright Act. If such acts allow unauthorized access to your software or other copyrighted work, you may have a right to sue for relief under that Act.

Information contained in this publication regarding device applications and the like is provided only for your convenience and may be superseded by updates. It is your responsibility to ensure that your application meets with your specifications. MICROCHIP MAKES NO REPRESENTATIONS OR WARRANTIES OF ANY KIND WHETHER EXPRESS OR IMPLIED, WRITTEN OR ORAL, STATUTORY OR OTHERWISE, RELATED TO THE INFORMATION, INCLUDING BUT NOT LIMITED TO ITS CONDITION, QUALITY, PERFORMANCE, MERCHANTABILITY OR FITNESS FOR PURPOSE. Microchip disclaims all liability arising from this information and its use. Use of Microchip devices in life support and/or safety applications is entirely at the buyer's risk, and the buyer agrees to defend, indemnify and hold harmless Microchip from any and all damages, claims, suits, or expenses resulting from such use. No licenses are conveyed, implicitly or otherwise, under any Microchip intellectual property rights.

Trademarks

The Microchip name and logo, the Microchip logo, Accuron, dsPIC, KEELOQ, microID, MPLAB, PIC, PICmicro, PICSTART, PRO MATE, PowerSmart, rPIC, and SmartShunt are registered trademarks of Microchip Technology Incorporated in the U.S.A. and other countries.

AmpLab, FilterLab, Migratable Memory, MXDEV, MXLAB, SEEVAL, SmartSensor and The Embedded Control Solutions Company are registered trademarks of Microchip Technology Incorporated in the U.S.A.

Analog-for-the-Digital Age, Application Maestro, CodeGuard, dsPICDEM, dsPICDEM.net, dsPICworks, ECAN, ECONOMONITOR, FanSense, FlexROM, fuzzyLAB, In-Circuit Serial Programming, ICSP, ICEPIC, Linear Active Thermistor, Mindi, MiWi, MPASM, MPLIB, MPLINK, PICkit, PICDEM, PICDEM.net, PICLAB, PICtail, PowerCal, PowerInfo, PowerMate, PowerTool, REAL ICE, rLAB, rPICDEM, Select Mode, Smart Serial, SmartTel, Total Endurance, UNI/O, WiperLock and ZENA are trademarks of Microchip Technology Incorporated in the U.S.A. and other countries.

SQTP is a service mark of Microchip Technology Incorporated in the U.S.A.

All other trademarks mentioned herein are property of their respective companies.

© 2007, Microchip Technology Incorporated, Printed in the U.S.A., All Rights Reserved.

 Printed on recycled paper.

QUALITY MANAGEMENT SYSTEM
CERTIFIED BY DNV
== ISO/TS 16949:2002 ==

Microchip received ISO/TS-16949:2002 certification for its worldwide headquarters, design and wafer fabrication facilities in Chandler and Tempe, Arizona, Gresham, Oregon and Mountain View, California. The Company's quality system processes and procedures are for its PIC[®] MCUs and dsPIC DSCs, KEELOQ[®] code hopping devices, Serial EEPROMs, microperipherals, nonvolatile memory and analog products. In addition, Microchip's quality system for the design and manufacture of development systems is ISO 9001:2000 certified.



WORLDWIDE SALES AND SERVICE

AMERICAS

Corporate Office

2355 West Chandler Blvd.
Chandler, AZ 85224-6199
Tel: 480-792-7200
Fax: 480-792-7277
Technical Support:
<http://support.microchip.com>
Web Address:
www.microchip.com

Atlanta

Duluth, GA
Tel: 678-957-9614
Fax: 678-957-1455

Boston

Westborough, MA
Tel: 774-760-0087
Fax: 774-760-0088

Chicago

Itasca, IL
Tel: 630-285-0071
Fax: 630-285-0075

Dallas

Addison, TX
Tel: 972-818-7423
Fax: 972-818-2924

Detroit

Farmington Hills, MI
Tel: 248-538-2250
Fax: 248-538-2260

Kokomo

Kokomo, IN
Tel: 765-864-8360
Fax: 765-864-8387

Los Angeles

Mission Viejo, CA
Tel: 949-462-9523
Fax: 949-462-9608

Santa Clara

Santa Clara, CA
Tel: 408-961-6444
Fax: 408-961-6445

Toronto

Mississauga, Ontario,
Canada
Tel: 905-673-0699
Fax: 905-673-6509

ASIA/PACIFIC

Asia Pacific Office

Suites 3707-14, 37th Floor
Tower 6, The Gateway
Harbour City, Kowloon
Hong Kong
Tel: 852-2401-1200
Fax: 852-2401-3431

Australia - Sydney

Tel: 61-2-9868-6733
Fax: 61-2-9868-6755

China - Beijing

Tel: 86-10-8528-2100
Fax: 86-10-8528-2104

China - Chengdu

Tel: 86-28-8665-5511
Fax: 86-28-8665-7889

China - Fuzhou

Tel: 86-591-8750-3506
Fax: 86-591-8750-3521

China - Hong Kong SAR

Tel: 852-2401-1200
Fax: 852-2401-3431

China - Qingdao

Tel: 86-532-8502-7355
Fax: 86-532-8502-7205

China - Shanghai

Tel: 86-21-5407-5533
Fax: 86-21-5407-5066

China - Shenyang

Tel: 86-24-2334-2829
Fax: 86-24-2334-2393

China - Shenzhen

Tel: 86-755-8203-2660
Fax: 86-755-8203-1760

China - Shunde

Tel: 86-757-2839-5507
Fax: 86-757-2839-5571

China - Wuhan

Tel: 86-27-5980-5300
Fax: 86-27-5980-5118

China - Xian

Tel: 86-29-8833-7250
Fax: 86-29-8833-7256

ASIA/PACIFIC

India - Bangalore

Tel: 91-80-4182-8400
Fax: 91-80-4182-8422

India - New Delhi

Tel: 91-11-4160-8631
Fax: 91-11-4160-8632

India - Pune

Tel: 91-20-2566-1512
Fax: 91-20-2566-1513

Japan - Yokohama

Tel: 81-45-471- 6166
Fax: 81-45-471-6122

Korea - Gumi

Tel: 82-54-473-4301
Fax: 82-54-473-4302

Korea - Seoul

Tel: 82-2-554-7200
Fax: 82-2-558-5932 or
82-2-558-5934

Malaysia - Penang

Tel: 60-4-646-8870
Fax: 60-4-646-5086

Philippines - Manila

Tel: 63-2-634-9065
Fax: 63-2-634-9069

Singapore

Tel: 65-6334-8870
Fax: 65-6334-8850

Taiwan - Hsin Chu

Tel: 886-3-572-9526
Fax: 886-3-572-6459

Taiwan - Kaohsiung

Tel: 886-7-536-4818
Fax: 886-7-536-4803

Taiwan - Taipei

Tel: 886-2-2500-6610
Fax: 886-2-2508-0102

Thailand - Bangkok

Tel: 66-2-694-1351
Fax: 66-2-694-1350

EUROPE

Austria - Wels

Tel: 43-7242-2244-39
Fax: 43-7242-2244-393

Denmark - Copenhagen

Tel: 45-4450-2828
Fax: 45-4485-2829

France - Paris

Tel: 33-1-69-53-63-20
Fax: 33-1-69-30-90-79

Germany - Munich

Tel: 49-89-627-144-0
Fax: 49-89-627-144-44

Italy - Milan

Tel: 39-0331-742611
Fax: 39-0331-466781

Netherlands - Drunen

Tel: 31-416-690399
Fax: 31-416-690340

Spain - Madrid

Tel: 34-91-708-08-90
Fax: 34-91-708-08-91

UK - Wokingham

Tel: 44-118-921-5869
Fax: 44-118-921-5820

12/08/06

Looking for pricing, stock, or lifecycle information?

Click below to explore more details on WIN SOURCE:

 [View PIC16F723-I/SS on WIN SOURCE](#)

 [Microchip Technology](#) Information

Optimize Your Supply Chain with WIN SOURCE Solutions

-  Global Sourcing Solution
-  Obsolete Management
-  Cost Control Management
-  Shortage Management
-  Alternative Solution
-  Excess Inventory Management