

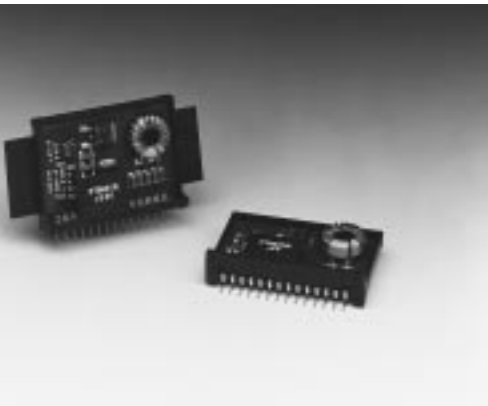

**THE DATASHEET OF
PT6601E**





- Single Device 9A Output
- Input Voltage Range: 3.1V to 6.0V
- Adjustable Output Voltage
- 90% Efficiency
- Remote Sense Capability
- Standby Function
- Over-Temperature Protection

In-line Package) Integrated Switching Regulators (ISRs), designed for stand-alone operation in applications requiring as much as 9A of output current.

The PT6600 series will operate off either a 3.3V or 5V input bus and requires only two external capacitors for proper operation. Please note that this product does not include short circuit protection.

The PT6600 series is a high performance family of 14-Pin SIP (Single

Standard Application

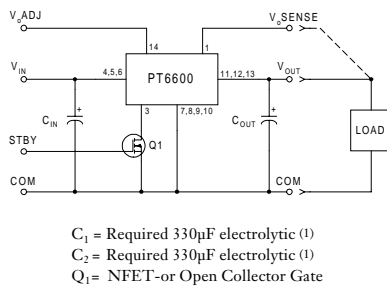

Pin-Out Information

Pin	Function
1	Remote Sense
2	Do not connect
3	STBY*-Standby
4	V _{in}
5	V _{in}
6	V _{in}
7	GND
8	GND
9	GND
10	GND
11	V _{out}
12	V _{out}
13	V _{out}
14	V _{out} Adjust

Ordering Information

PT6601!	= +3.3 Volts
†PT6602!	= +1.5 Volts
PT6603!	= +2.5 Volts
PT6604!	= +3.6 Volts
†PT6605!	= +1.2 Volts
†PT6606!	= +1.8 Volts

†3.3V Input Bus Capable

PT Series Suffix (PT1234X)

Case/Pin Configuration	Heat Spreader	Heat Spreader with Side Tabs
Vertical Through-Hole	P	R
Horizontal Through-Hole	D	G
Horizontal Surface Mount	E	B

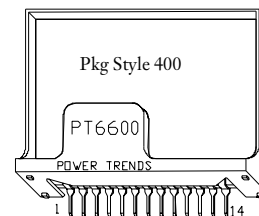

Note: Back surface of product is conducting metal.

Specifications

Characteristics (T _a = 25°C unless noted)	Symbols	Conditions	PT6600 SERIES			Units
			Min	Typ	Max	
Output Current	I _o	T _a = 60°C, 200 LFM, pkg P T _a = 25°C, natural convection	0.1 (2) 0.1 (2)	—	9.0 (4) 7.0 (4)	A
Input Voltage Range	V _{in}	0.1A ≤ I _o ≤ 8.0A	4.5 3.1 4.8	—	6.0 6.0 6.0	V
Output Voltage Tolerance	ΔV _o	V _{in} = +5V, I _o = 8.0A T _a = 0°C to 65°C	V _o -0.1	—	V _o +0.1	V
Output Voltage Adjust Range	V _{oadj}	Pin 14 to V _o or ground V _{in} min = +3.1V or V _o + 1.2V (whichever is greater)	2.25 1.27 1.80 2.50	—	4.20 2.65 3.50 4.30	V
Line Regulation	Reg _{line}	4.5V ≤ V _{in} ≤ 6.0V, I _o = 8.0A 3.1V ≤ V _{in} ≤ 6.0V, I _o = 8.0A 4.5V ≤ V _{in} ≤ 6.0V, I _o = 8.0A	—	±7 ±3 ±7	±17 ±8 ±13	mV
Load Regulation	Reg _{load}	V _{in} = +5V, 0.1 ≤ I _o ≤ 8.0A	—	±17 ±12 ±13	±33 ±23 ±25	mV
V _o Ripple/Noise	V _n	V _{in} = 5V, I _o = 8.0A	—	50	—	mV _{pp}
Transient Response with C ₂ = 330 μ F	t _{tr} V _{os}	I _o step between 4.0A and 8.0A V _o over/undershoot	—	100 150	—	μ Sec mV
Efficiency	η	V _{in} = +5V, I _o = 3.0A	—	90 76 85	—	%
		V _{in} = +5V, I _o = 8.0A	—	83 68 76	—	%
Switching Frequency	f _o	3.1V ≤ V _{in} ≤ 6.0V 0.1A ≤ I _o ≤ 8.0A	475	600	725	kHz
Absolute Maximum Operating Temperature Range	T _a	Over V _{in} range	-40 (3)	—	+85 (4)	°C
Thermal Resistance	θ _{ja}	Free Air Convection (40-60 LFM)	—	25	—	°C/W

Continued

PT6600 Series

9 Amp 5V/3.3V Input Adjustable Integrated Switching Regulator

Specifications (continued)

Characteristics ($T_A = 25^\circ\text{C}$ unless noted)	Symbols	Conditions	PT6600 SERIES			Units
			Min	Typ	Max	
Storage Temperature	T_s	—	-40	—	+125	$^\circ\text{C}$
Mechanical Shock	—	Per Mil-STD-883D, Method 2002.3	—	500	—	G's
Mechanical Vibration	—	Per Mil-STD-883D, Method 2007.2, 20-2000 Hz, soldered in a PC board	—	7.5	—	G's
Weight	—	—	—	14	—	grams

- Notes: (1) The PT6600 series requires two 330 μF electrolytic capacitors (input and output) for proper operation in all applications. The input capacitance must be rated for a minimum of 1.1 Arms of ripple current. See the application note, PT6500/6600 Series Capacitor Recommendations.
 (2) ISR will operate down to no load with reduced specifications.
 (3) For operation below 0°C , use tantalum capacitors for C_{IN} and C_{OUT} . For more information, contact an Application Specialist.
 (4) See Safe Operating Curves, or contact the factory for the appropriate derating.

TYPICAL CHARACTERISTICS

Safe Operating Area Curves (@ $V_{in} = +5.0\text{V}$) (See Note B)

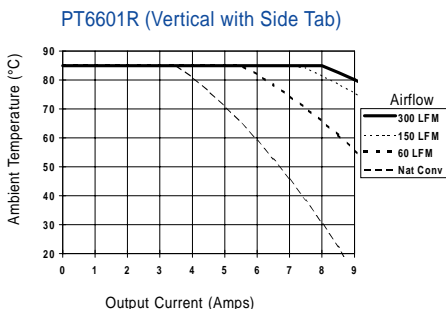
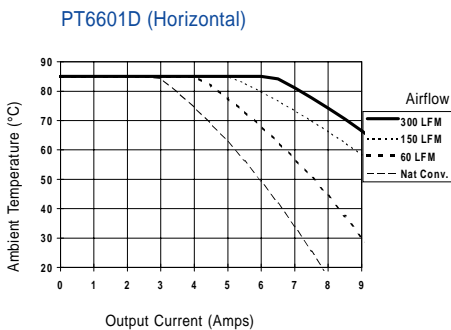
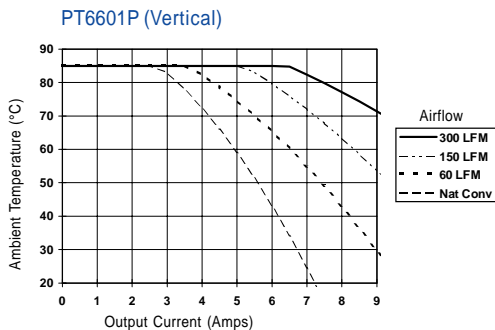

PT6601, 3.3 VDC (See Note A)

Efficiency vs Output Current

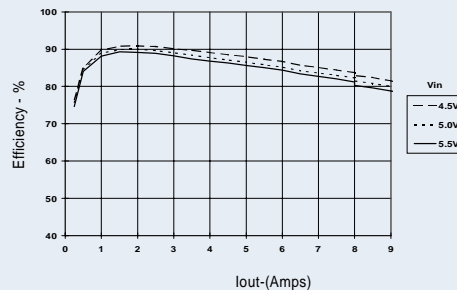

Ripple vs Output Current

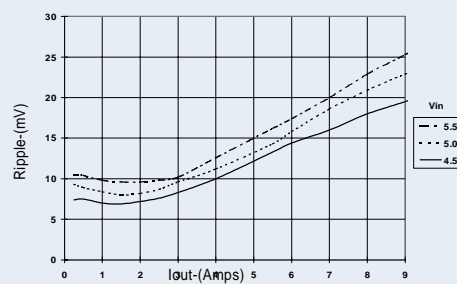

Power Dissipation vs Output Current

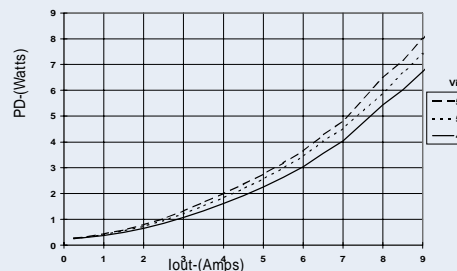

Note A: All data listed in the above graphs has been developed from actual products tested at 25°C . This data is considered typical data for the ISR.

Note B: SOA curves represent operating conditions at which internal components are at or below manufacturer's maximum rated operating temperatures.

PT6600 Series

Table 2

PT6600 ADJUSTMENT RESISTOR VALUES								
Series Pt #	PT6605	PT6607	PT6602	PT6608	PT6606	PT6603	PT6601	PT6604
V_O (nom)	1.2	1.3	1.5	1.7	1.8	2.5	3.3	3.6
V_a (req'd)								
1.15	(5.5)k Ω							
1.2		(3.0)k Ω						
1.25	47.8k Ω	(10.5)k Ω						
1.3	22.9k Ω		(1.7)k Ω					
1.35	14.6k Ω	47.8k Ω	(3.8)k Ω					
1.4	10.5k Ω	22.9k Ω	(8.0)k Ω	(1.3)k Ω	(0.5)k Ω			
1.45	8.0k Ω	14.6k Ω	(20.4)k Ω	(2.5)k Ω	(1.2)k Ω			
1.5	6.3k Ω	10.5k Ω		(4.2)k Ω	(2.2)k Ω			
1.55	5.1k Ω	8.0k Ω	47.8k Ω	(7.1)k Ω	(3.5)k Ω			
1.6	4.2k Ω	6.3k Ω	22.9k Ω	(12.9)k Ω	(5.5)k Ω			
1.65	3.5k Ω	4.1k Ω	14.6k Ω	(30.4)k Ω	(8.8)k Ω			
1.7	3.0k Ω	4.2k Ω	10.5k Ω		(15.4)k Ω			
1.75	2.5k Ω	3.5k Ω	8.0k Ω	47.8k Ω	(35.4)k Ω			
1.8	2.2k Ω	3.0k Ω	6.3k Ω	22.9k Ω		(1.5)k Ω		
1.85	1.8k Ω	2.5k Ω	5.1k Ω	14.6k Ω	47.8k Ω	(2.3)k Ω		
1.9	1.6k Ω	2.2k Ω	4.2k Ω	10.5k Ω	22.9k Ω	(3.3)k Ω		
1.95	1.3k Ω	1.8k Ω	3.5k Ω	8.0k Ω	14.6k Ω	(4.4)k Ω		
2.0	1.1k Ω	1.6k Ω	3.0k Ω	6.3k Ω	10.5k Ω	(5.8)k Ω		
2.05	0.9k Ω	1.3k Ω	2.5k Ω	5.1k Ω	8.0k Ω	(7.4)k Ω		
2.1	0.8k Ω	1.1k Ω	2.2k Ω	4.2k Ω	6.3k Ω	(9.5)k Ω		
2.15	0.6k Ω	0.9k Ω	1.8k Ω	3.5k Ω	5.1k Ω	(12.2)k Ω		
2.2	0.5k Ω	0.8k Ω	1.6k Ω	3.0k Ω	4.2k Ω	(15.7)k Ω		
2.25	0.4k Ω	0.6k Ω	1.3k Ω	2.5k Ω	3.5k Ω	(20.7)k Ω	(2.3)k Ω	
2.3	0.3k Ω	0.5k Ω	1.1k Ω	2.2k Ω	3.0k Ω	(28.2)k Ω	(3.6)k Ω	
2.35	0.2k Ω	0.4k Ω	0.9k Ω	1.8k Ω	2.5k Ω	(40.7)k Ω	(5.1)k Ω	
2.4		0.3k Ω	0.8k Ω	1.6k Ω	2.2k Ω	(65.6)k Ω	(6.7)k Ω	
2.45		0.2k Ω	0.6k Ω	1.3k Ω	1.8k Ω	(140.0)k Ω	(8.5)k Ω	
2.5			0.5k Ω	1.1k Ω	1.6k Ω		(10.6)k Ω	(1.5)k Ω
2.55			0.4k Ω	0.9k Ω	1.3k Ω	95.6k Ω	(12.9)k Ω	(2.7)k Ω
2.6			0.3k Ω	0.8k Ω	1.1k Ω	45.7k Ω	(15.6)k Ω	(3.9)k Ω
2.65			0.2k Ω	0.6k Ω	6.9k Ω	29.0k Ω	(18.6)k Ω	(5.3)k Ω
2.7				0.5k Ω	0.8k Ω	20.7k Ω	(22.2)k Ω	(6.8)k Ω
2.75				0.4k Ω	0.6k Ω	15.7k Ω	(26.4)k Ω	(8.5)k Ω
2.8				0.3k Ω	0.5k Ω	12.4k Ω	(31.5)k Ω	(10.4)k Ω
2.85				0.2k Ω	0.4k Ω	10.0k Ω	(37.6)k Ω	(12.6)k Ω
2.9					0.3k Ω	8.3k Ω	(45.4)k Ω	(15.0)k Ω
2.95					0.2k Ω	0.9k Ω	(55.3)k Ω	(17.9)k Ω
3.0						5.8k Ω	(68.6)k Ω	(21.2)k Ω
3.1						4.1k Ω	(115.0)k Ω	(29.9)k Ω
3.2						2.9k Ω	(254.0)k Ω	(42.9)k Ω
3.3						2.0k Ω		(64.6)k Ω
3.4						1.3k Ω	109.0k Ω	(108.0)k Ω
3.5						0.8k Ω	48.4k Ω	(238.0)k Ω
3.6							28.2k Ω	
3.7							18.2k Ω	87.9k Ω
3.8							12.1k Ω	37.9k Ω
3.9	4/. $V_{OUT} > 3.8V_{dc}$ requires $V_{IN} > 5.0V_{dc}$!						8.1k Ω	21.2k Ω
4.0							5.2k Ω	12.9k Ω
4.1							3.0k Ω	7.9k Ω
4.2							1.3k Ω	4.6k Ω
4.3								2.2k Ω

R1 = (Blue) R2 = Black

PT6600 Series

Using the Standby Function on the PT6600 5V Bus Converters

For applications requiring output voltage On/Off control, the 14-pin PT6600 ISR series incorporates a standby function. This function may be used in applications that require power-up/shutdown sequencing, and wherever there is a requirement for the output status of the module to be controlled by external circuitry.

The standby function is provided by the *STBY** control, pin 3. If pin 3 is left open-circuit the regulator operates normally, and provides a regulated output when a valid supply voltage is applied to V_{in} (pins 4, 5, & 6) with respect to GND (pins 7-10). If a low voltage² is then applied to pin-3 the regulator output will be disabled and the input current drawn by the ISR will drop to less than 50mA⁴. The standby control may also be used to hold-off the regulator output during the period that input power is applied.

The standby control pin is ideally controlled using an open-collector (or open-drain) discrete transistor (See Figure 1). It may also be driven directly from a dedicated TTL³ compatible gate. Table 1 provides details of the threshold requirements.

Table 1 Inhibit Control Thresholds ^(2,3)

Parameter	Min	Max
Enable (V_{IH})	1V	5V
Disable (V_{IL})	-0.1V	0.35V

Notes:

1. The Standby/Inhibit control logic is similar for all Power Trends' modules, but the flexibility and threshold tolerances will be different. For specific information on this function for other regulator models, consult the applicable application note.
2. The Standby control pin is ideally controlled using an open-collector (or open-drain) discrete transistor and requires no external pull-up resistor. The control input has an open-circuit voltage of about 1Vdc. To disable the regulator output, the control pin must be pulled to less than 0.35Vdc with a low-level 0.5mA sink to ground.
3. The Standby input on the PT6600 series may be driven by a differential output device, making it compatible with TTL logic. A standard TTL logic gate will meet the 0.35V $V_{IL(max)}$ requirement (Table 1) at 0.5mA I_{OL} . *Do not* use devices that can drive the Standby control input above 5Vdc.
4. When the regulator output is disabled the current drawn from the input source is reduced to approximately 30–40mA (50mA maximum).

Figure 1

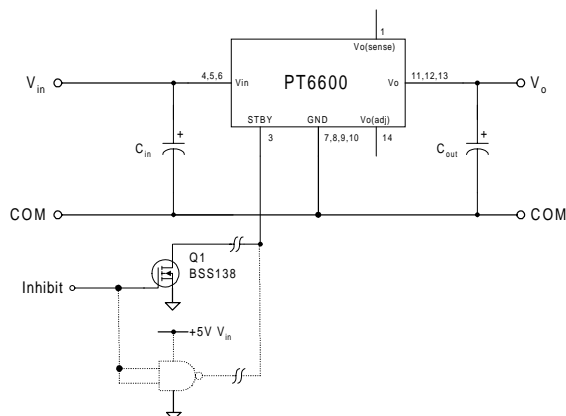

Turn-On Time: In the circuit of Figure 1, turning Q_1 on applies a low voltage to the Standby control (pin 3) and disables the regulator output. Correspondingly, turning Q_1 off releases the low-voltage signal and enables the output. The PT6600 ISR series regulators have a fast response and will provide a fully regulated output voltage within 250 μ sec. The actual turn-on time will vary with load and the total amount of output capacitance. The waveform of Figure 2 shows the typical output voltage response of a PT6601 (3.3V) following the turn-off of Q_1 at time $t = 0.0$ secs. The waveform was measured with a 5Vdc input voltage, and 0.6 Ω load.

Figure 2

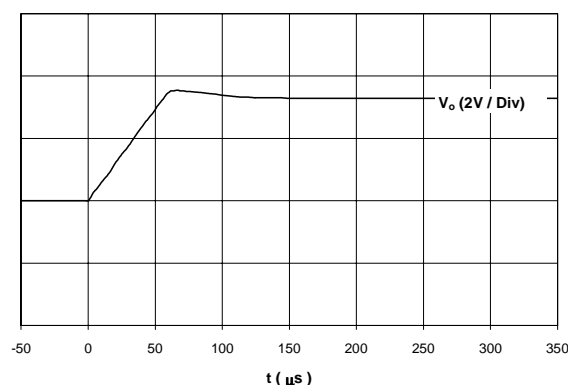

IMPORTANT NOTICE

Texas Instruments and its subsidiaries (TI) reserve the right to make changes to their products or to discontinue any product or service without notice, and advise customers to obtain the latest version of relevant information to verify, before placing orders, that information being relied on is current and complete. All products are sold subject to the terms and conditions of sale supplied at the time of order acknowledgment, including those pertaining to warranty, patent infringement, and limitation of liability.

TI warrants performance of its semiconductor products to the specifications applicable at the time of sale in accordance with TI's standard warranty. Testing and other quality control techniques are utilized to the extent TI deems necessary to support this warranty. Specific testing of all parameters of each device is not necessarily performed, except those mandated by government requirements.

Customers are responsible for their applications using TI components.

In order to minimize risks associated with the customer's applications, adequate design and operating safeguards must be provided by the customer to minimize inherent or procedural hazards.

TI assumes no liability for applications assistance or customer product design. TI does not warrant or represent that any license, either express or implied, is granted under any patent right, copyright, mask work right, or other intellectual property right of TI covering or relating to any combination, machine, or process in which such semiconductor products or services might be or are used. TI's publication of information regarding any third party's products or services does not constitute TI's approval, warranty or endorsement thereof.

Looking for pricing, stock, or lifecycle information?

Click below to explore more details on WIN SOURCE:

 [View PT6601E on WIN SOURCE](#)

 [Texas Instruments](#) Information

Optimize Your Supply Chain with WIN SOURCE Solutions

-  Global Sourcing Solution
-  Obsolete Management
-  Cost Control Management
-  Shortage Management
-  Alternative Solution
-  Excess Inventory Management