

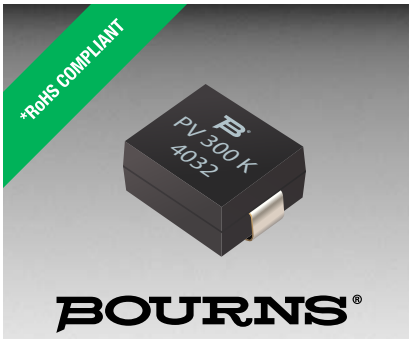

**THE DATASHEET OF
PV95K4032R2**





Features

- Formerly a **KEKOVARICON** product
- Two model sizes available - 3255 & 4032
- Operating voltage range (V_{dc}) 14 V to 385 V
- Operating voltage (V_{rms}) 11 V to 300 V
- +85 °C Continuous operating temperature
- UL 94 V-0 Non-flammable thermoplastic encapsulation

- Easily solderable tinned copper sheet
- Available in tape and reel packaging for automatic pick-and-place
- RoHS compliant*

PV Series - Low & Medium Voltage Plastic-Encapsulated Varistors

General Information

The PV series of low and medium voltage plastic-encapsulated varistors is designed to protect electronic equipment against voltage surges in the low and medium voltage region. They offer direct SMD equivalents to leaded disc varistors of 5 and 7 mm sizes. The thermoplastic encapsulation is non-flammable and UL 94 V-0 rated. Contacts are made of tinned copper sheet.

PV series varistors are designed for surface mounting and are available in two model sizes.

These transient voltage suppressors cover an operating voltage V_{rms} from 11 V to 300 V, featuring maximum surge currents from 100 A to 1200 A.

Absolute Maximum Ratings

Parameter	Value	Units
Continuous:		
Steady State Applied Voltage		
DC Voltage Range (V_{dc})	14 to 385	V
AC Voltage Range (V_{rms})	11 to 300***	V
Transient:		
Non-Repetitive Surge Current, 8/20 μ s Waveform (I_{max})	100 to 1200	A
Non-Repetitive Surge Energy, 10/1000 μ s Waveform (W_{max})	0.6 to 30	J
Operating Ambient Temperature	-40 to +85	°C
Storage Temperature Range	-40 to +125	°C
Threshold Voltage Temperature Coefficient	< +0.05	%/°C
Response Time	< 5	ns
Climatic Category	40 / 85 / 56	

***Varistors with rated voltages of 11 V_{rms} to 50 V_{rms} are non-standard and available only upon request.

Additional Information

Click these links for more information:



[PRODUCT SELECTOR](#) [TECHNICAL LIBRARY](#) [INVENTORY](#) [SAMPLES](#) [CONTACT](#)

Agency Recognition

Standard	UL 1449
File Number	E313168**

**Not all rated voltages are UL recognized; check the file for details.

Varistor Symbol

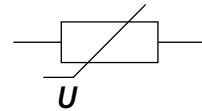

Index

Features	1
General Information	1
Agency Recognition	1
Varistor Symbol	1
Absolute Maximum Ratings	1
Applications	2
Device Ratings	2
Product Dimensions	3-4
How to Order	4
Typical Part Marking	4
Protection Level/ Pulse Rating Curves	5-6
Soldering Pad Configuration	7
Packaging Specifications	8
Soldering Recommendations for SMD Components	9-10
Reliability Testing Procedures	11-12
Terminology	13
Legal Disclaimer	14



Asia-Pacific: Tel: +886-2 2562-4117 • Email: asiacus@bourns.com

EMEA: Tel: +36 88 885 877 • Email: eurocus@bourns.com

The Americas: Tel: +1-951 781-5500 • Email: americus@bourns.com

www.bourns.com



WARNING Cancer and Reproductive Harm - www.P65Warnings.ca.gov

*RoHS Directive 2015/863, Mar 31, 2015 and Annex.

Specifications are subject to change without notice.

Users should verify actual device performance in their specific applications.

The products described herein and this document are subject to specific legal disclaimers as set forth on the last page of this document, and at www.bourns.com/docs/legal/disclaimer.pdf.

Applications

- Electricity meters
- White goods
- Entertainment electronics
- Power supplies
- Distribution panels
- Sensors

PV Series - Low & Medium Voltage Plastic-Encapsulated Varistors **BOURNS®**

Device Ratings

Model	V _{rms}	V _{dc}	V _n @ 1 mA	V _c	I _c	W _{max} 10/1000 μs	P max.	I _{max} 8/20 μs	C Typ. @ 1 kHz
	V	V	V	V	A	J	W	A	pF
PV 11 K 3225	11	14	18	36	2.5	0.6	0.01	100	1600
PV 11 K 4032	11	14	18	36	5	1.1	0.02	250	3100
PV 14 K 3225	14	18	22	43	2.5	0.7	0.01	100	1300
PV 14 K 4032	14	18	22	43	5	1.3	0.02	250	2500
PV 17 K 3225	17	22	27	53	2.5	0.9	0.01	100	1050
PV 17 K 4032	17	22	27	53	5	1.6	0.02	250	1900
PV 20 K 3225	20	26	33	65	2.5	1.1	0.01	100	750
PV 20 K 4032	20	26	33	65	5	2.0	0.02	250	1500
PV 25 K 3225	25	31	39	77	2.5	1.2	0.01	100	660
PV 25 K 4032	25	31	39	77	5	2.4	0.02	250	1260
PV 30 K 3225	30	38	47	93	2.5	1.5	0.01	100	580
PV 30 K 4032	30	38	47	93	5	2.8	0.02	250	1050
PV 35 K 3225	35	45	56	110	2.5	1.8	0.01	100	460
PV 35 K 4032	35	45	56	110	5	3.4	0.02	250	850
PV 40 K 3225	40	56	68	135	2.5	2.2	0.01	100	400
PV 40 K 4032	40	56	68	135	5	4.1	0.02	250	720
PV 50 K 3225	50	65	82	135	5	2.5	0.10	400	390
PV 50 K 4032	50	65	82	135	10	6.5	0.25	1200	820
PV 60 K 3225	60	85	100	165	5	3.0	0.10	400	330
PV 60 K 4032	60	85	100	165	10	7.0	0.25	1200	680
PV 75 K 3225	75	100	120	200	5	4.0	0.10	400	270
PV 75 K 4032	75	100	120	200	10	9.0	0.25	1200	550
PV 95 K 3225	95	125	150	250	5	6.0	0.10	400	220
PV 95 K 4032	95	125	150	250	10	11.0	0.25	1200	440
PV 115 K 3225	115	150	180	300	5	6.5	0.10	400	180
PV 115 K 4032	115	150	180	300	10	13.0	0.25	1200	360
PV 130 K 3225	130	170	205	340	5	7.0	0.10	400	160
PV 130 K 4032	130	170	205	340	10	15.0	0.25	1200	320
PV 140 K 3225	140	180	220	360	5	7.5	0.10	400	150
PV 140 K 4032	140	180	220	360	10	18.0	0.25	1200	300
PV 150 K 3225	150	200	240	395	5	9.0	0.10	400	140
PV 150 K 4032	150	200	240	395	10	18.5	0.25	1200	280
PV 175 K 3225	175	225	270	455	5	9.5	0.10	400	120
PV 175 K 4032	175	225	270	455	10	21.0	0.25	1200	250
PV 230 K 3225	230	300	360	595	5	10.0	0.10	400	95
PV 230 K 4032	230	300	360	595	10	23.0	0.25	1200	190
PV 250 K 3225	250	320	390	650	5	11.0	0.10	400	80
PV 250 K 4032	250	320	390	650	10	25.0	0.25	1200	180
PV 275 K 3225	275	350	430	710	5	13.0	0.10	400	75
PV 275 K 4032	275	350	430	710	10	29.0	0.25	1200	160
PV 300 K 3225	300	385	470	775	5	15.0	0.10	400	70
PV 300 K 4032	300	385	470	775	10	30.0	0.25	1200	150

Specifications are subject to change without notice.

Users should verify actual device performance in their specific applications.

The products described herein and this document are subject to specific legal disclaimers as set forth on the last page of this document, and at www.bourns.com/docs/legal/disclaimer.pdf.

PV Series - Low & Medium Voltage Plastic-Encapsulated Varistors **BOURNS®**

Product Dimensions

Model	Dimension			
	$h \pm \frac{0.3}{(.012)}$	$L \pm \frac{0.5}{(.020)}$	$W \pm \frac{0.4}{(.016)}$	$t \pm \frac{0.3}{(.012)}$
PV 11 K 3225	$\frac{1.7}{(.066)}$	$\frac{8.0}{(.315)}$	$\frac{6.3}{(.248)}$	$\frac{3.4}{(.134)}$
PV 11 K 4032	$\frac{2.3}{(.091)}$	$\frac{10.0}{(.394)}$	$\frac{8.0}{(.315)}$	$\frac{4.7}{(.185)}$
PV 14 K 3225	$\frac{1.7}{(.066)}$	$\frac{8.0}{(.315)}$	$\frac{6.3}{(.248)}$	$\frac{3.4}{(.134)}$
PV 14 K 4032	$\frac{2.3}{(.091)}$	$\frac{10.0}{(.394)}$	$\frac{8.0}{(.315)}$	$\frac{4.7}{(.185)}$
PV 17 K 3225	$\frac{1.7}{(.066)}$	$\frac{8.0}{(.315)}$	$\frac{6.3}{(.248)}$	$\frac{3.4}{(.134)}$
PV 17 K 4032	$\frac{2.3}{(.091)}$	$\frac{10.0}{(.394)}$	$\frac{8.0}{(.315)}$	$\frac{4.7}{(.185)}$
PV 20 K 3225	$\frac{1.7}{(.066)}$	$\frac{8.0}{(.315)}$	$\frac{6.3}{(.248)}$	$\frac{3.4}{(.134)}$
PV 20 K 4032	$\frac{2.3}{(.091)}$	$\frac{10.0}{(.394)}$	$\frac{8.0}{(.315)}$	$\frac{4.7}{(.185)}$
PV 25 K 3225	$\frac{1.7}{(.066)}$	$\frac{8.0}{(.315)}$	$\frac{6.3}{(.248)}$	$\frac{3.4}{(.134)}$
PV 25 K 4032	$\frac{2.3}{(.091)}$	$\frac{10.0}{(.394)}$	$\frac{8.0}{(.315)}$	$\frac{4.7}{(.185)}$
PV 30 K 3225	$\frac{1.7}{(.066)}$	$\frac{8.0}{(.315)}$	$\frac{6.3}{(.248)}$	$\frac{3.4}{(.134)}$
PV 30 K 4032	$\frac{2.3}{(.091)}$	$\frac{10.0}{(.394)}$	$\frac{8.0}{(.315)}$	$\frac{4.7}{(.185)}$
PV 35 K 3225	$\frac{1.7}{(.066)}$	$\frac{8.0}{(.315)}$	$\frac{6.3}{(.248)}$	$\frac{3.4}{(.134)}$
PV 35 K 4032	$\frac{2.3}{(.091)}$	$\frac{10.0}{(.394)}$	$\frac{8.0}{(.315)}$	$\frac{4.7}{(.185)}$
PV 40 K 3225	$\frac{1.7}{(.066)}$	$\frac{8.0}{(.315)}$	$\frac{6.3}{(.248)}$	$\frac{3.4}{(.134)}$
PV 40 K 4032	$\frac{2.3}{(.091)}$	$\frac{10.0}{(.394)}$	$\frac{8.0}{(.315)}$	$\frac{4.7}{(.185)}$
PV 50 K 3225	$\frac{1.7}{(.066)}$	$\frac{8.0}{(.315)}$	$\frac{6.3}{(.248)}$	$\frac{3.4}{(.134)}$
PV 50 K 4032	$\frac{2.3}{(.091)}$	$\frac{10.0}{(.394)}$	$\frac{8.0}{(.315)}$	$\frac{4.7}{(.185)}$
PV 60 K 3225	$\frac{1.7}{(.066)}$	$\frac{8.0}{(.315)}$	$\frac{6.3}{(.248)}$	$\frac{3.4}{(.134)}$
PV 60 K 4032	$\frac{2.3}{(.091)}$	$\frac{10.0}{(.394)}$	$\frac{8.0}{(.315)}$	$\frac{4.7}{(.185)}$
PV 75 K 3225	$\frac{1.7}{(.066)}$	$\frac{8.0}{(.315)}$	$\frac{6.3}{(.248)}$	$\frac{3.4}{(.134)}$
PV 75 K 4032	$\frac{2.3}{(.091)}$	$\frac{10.0}{(.394)}$	$\frac{8.0}{(.315)}$	$\frac{4.7}{(.185)}$
PV 95 K 3225	$\frac{1.7}{(.066)}$	$\frac{8.0}{(.315)}$	$\frac{6.3}{(.248)}$	$\frac{3.4}{(.134)}$
PV 95 K 4032	$\frac{2.3}{(.091)}$	$\frac{10.0}{(.394)}$	$\frac{8.0}{(.315)}$	$\frac{4.7}{(.185)}$
PV 115 K 3225	$\frac{1.7}{(.066)}$	$\frac{8.0}{(.315)}$	$\frac{6.3}{(.248)}$	$\frac{3.4}{(.134)}$
PV 115 K 4032	$\frac{2.3}{(.091)}$	$\frac{10.0}{(.394)}$	$\frac{8.0}{(.315)}$	$\frac{4.7}{(.185)}$
PV 130 K 3225	$\frac{1.7}{(.066)}$	$\frac{8.0}{(.315)}$	$\frac{6.3}{(.248)}$	$\frac{3.4}{(.134)}$
PV 130 K 4032	$\frac{2.3}{(.091)}$	$\frac{10.0}{(.394)}$	$\frac{8.0}{(.315)}$	$\frac{4.7}{(.185)}$
PV 140 K 3225	$\frac{1.7}{(.066)}$	$\frac{8.0}{(.315)}$	$\frac{6.3}{(.248)}$	$\frac{3.4}{(.134)}$
PV 140 K 4032	$\frac{2.3}{(.091)}$	$\frac{10.0}{(.394)}$	$\frac{8.0}{(.315)}$	$\frac{4.7}{(.185)}$

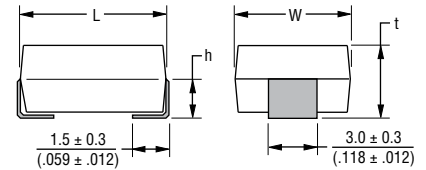

DIMENSIONS: $\frac{\text{MM}}{\text{(INCHES)}}$

Specifications are subject to change without notice.

Users should verify actual device performance in their specific applications.

The products described herein and this document are subject to specific legal disclaimers as set forth on the last page of this document, and at www.bourns.com/docs/legal/disclaimer.pdf.

PV Series - Low & Medium Voltage Plastic-Encapsulated Varistors **BOURNS®**

Product Dimensions (Continued)

Model	Dimension			
	$h \pm \frac{0.3}{(.012)}$	$L \pm \frac{0.5}{(.020)}$	$W \pm \frac{0.4}{(.016)}$	$t \pm \frac{0.3}{(.012)}$
PV 150 K 3225	$\frac{1.7}{(.066)}$	$\frac{8.0}{(.315)}$	$\frac{6.3}{(.248)}$	$\frac{3.4}{(.134)}$
PV 150 K 4032	$\frac{2.3}{(.091)}$	$\frac{10.0}{(.394)}$	$\frac{8.0}{(.315)}$	$\frac{4.7}{(.185)}$
PV 175 K 3225	$\frac{2.3}{(.091)}$	$\frac{8.0}{(.315)}$	$\frac{6.3}{(.248)}$	$\frac{4.7}{(.185)}$
PV 175 K 4032	$\frac{2.3}{(.091)}$	$\frac{10.0}{(.394)}$	$\frac{8.0}{(.315)}$	$\frac{4.7}{(.185)}$
PV 230 K 3225	$\frac{2.3}{(.091)}$	$\frac{8.0}{(.315)}$	$\frac{6.3}{(.248)}$	$\frac{4.7}{(.185)}$
PV 230 K 4032	$\frac{2.3}{(.091)}$	$\frac{10.0}{(.394)}$	$\frac{8.0}{(.315)}$	$\frac{4.7}{(.185)}$
PV 250 K 3225	$\frac{2.3}{(.091)}$	$\frac{8.0}{(.315)}$	$\frac{6.3}{(.248)}$	$\frac{4.7}{(.185)}$
PV 250 K 4032	$\frac{2.3}{(.091)}$	$\frac{10.0}{(.394)}$	$\frac{8.0}{(.315)}$	$\frac{4.7}{(.185)}$
PV 275 K 3225	$\frac{2.3}{(.091)}$	$\frac{8.0}{(.315)}$	$\frac{6.3}{(.248)}$	$\frac{4.7}{(.185)}$
PV 275 K 4032	$\frac{2.3}{(.091)}$	$\frac{10.0}{(.394)}$	$\frac{8.0}{(.315)}$	$\frac{4.7}{(.185)}$
PV 300 K 3225	$\frac{2.3}{(.091)}$	$\frac{8.0}{(.315)}$	$\frac{6.3}{(.248)}$	$\frac{4.7}{(.185)}$
PV 300 K 4032	$\frac{2.3}{(.091)}$	$\frac{10.0}{(.394)}$	$\frac{8.0}{(.315)}$	$\frac{4.7}{(.185)}$

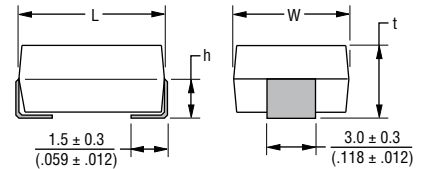

DIMENSIONS: $\frac{\text{MM}}{\text{(INCHES)}}$

How to Order

PV20K3225R2yy

- Series Designator
PV = PV Series
- Max. Continuous Operating Voltage (V_{rms})
- V_n Tolerance
K = $\pm 10\%$
- Model Size
• 3225
• 4032
- Packaging
R2 = 330 mm Reel
- Special Requirements
• yy

Instructions for Creating Orderable Part Number:

- 1) Start with base part number in characteristics table (example: PV20K3225).
- 2) Add Packaging: R2 (example part number becomes PV20K3225R2).
- 3) Part number can have no spaces or lower case letters.

Typical Part Marking

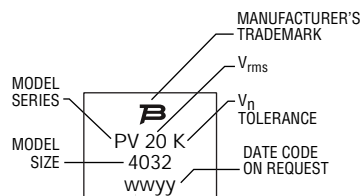

Specifications are subject to change without notice.

Users should verify actual device performance in their specific applications.

The products described herein and this document are subject to specific legal disclaimers as set forth on the last page of this document, and at www.bourns.com/docs/legal/disclaimer.pdf.

PV Series - Low & Medium Voltage Plastic-Encapsulated Varistors **BOURNS®**

Protection Level

Model Size 3225 - (PV50 ~ PV300)

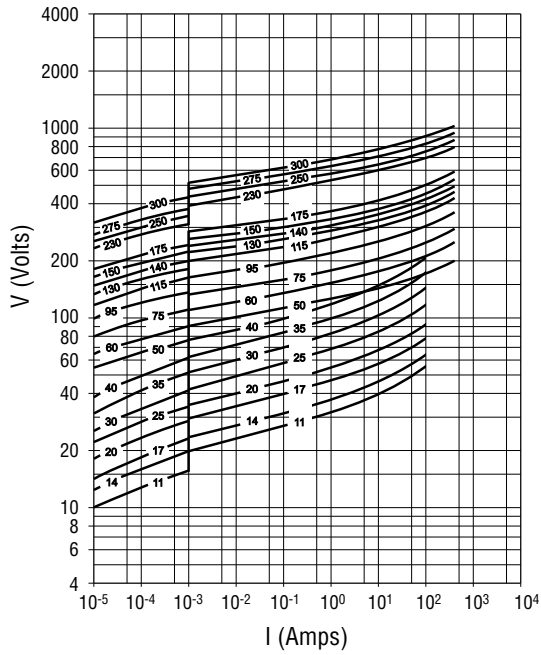

Pulse Rating Curves

Model Size 3225 - (PV11 ~ PV40)

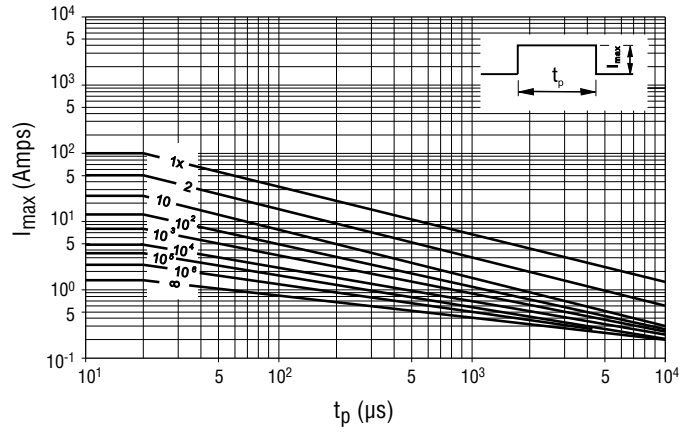

Model Size 3225 - (PV50 ~ PV300)

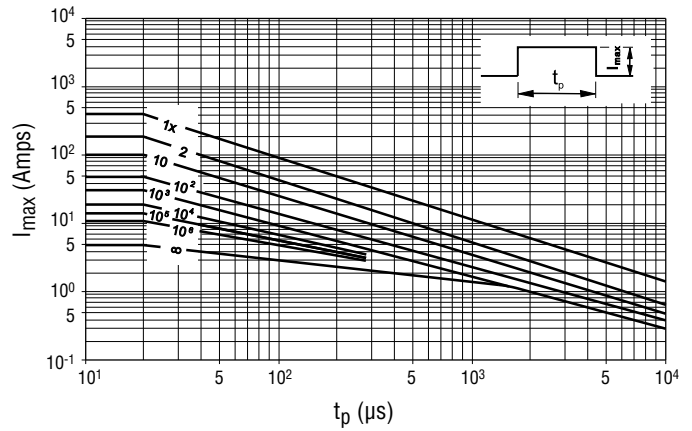

Specifications are subject to change without notice.

Users should verify actual device performance in their specific applications.

The products described herein and this document are subject to specific legal disclaimers as set forth on the last page of this document, and at www.bourns.com/docs/legal/disclaimer.pdf.

PV Series - Low & Medium Voltage Plastic-Encapsulated Varistors **BOURNS®**

Protection Level

Model Size 4032 - (PV11 ~ PV300)

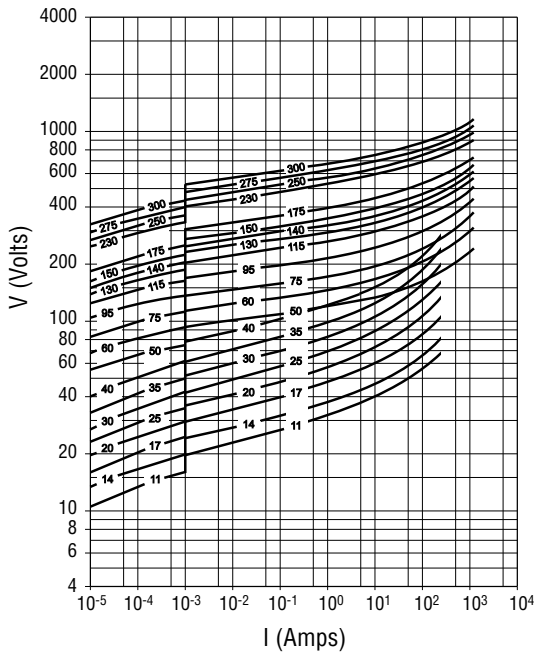

Pulse Rating Curves

Model Size 4032 - (PV11 ~ PV40)

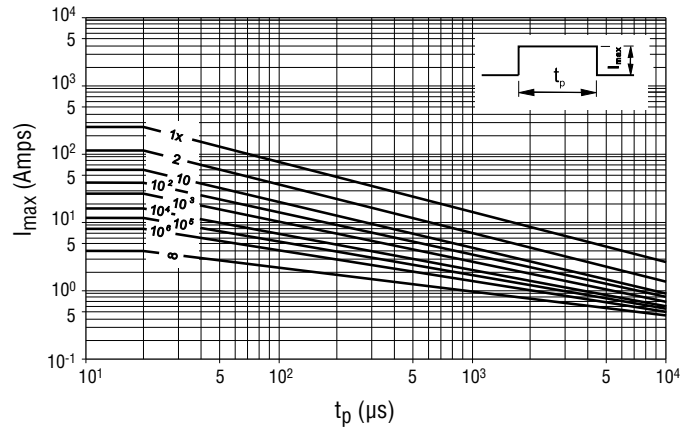

Model Size 4032 - (PV50 ~ PV300)

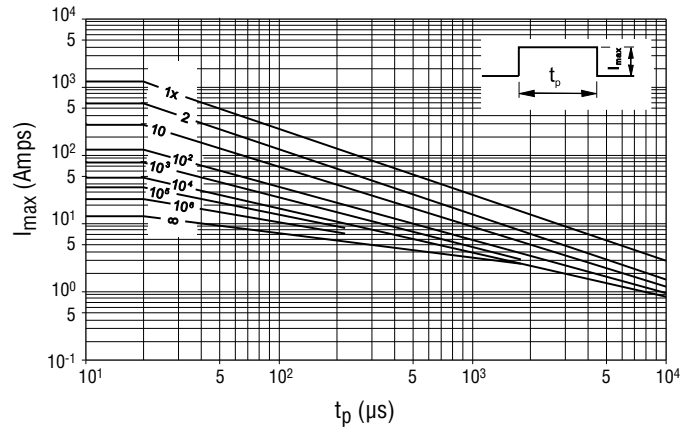

Specifications are subject to change without notice.

Users should verify actual device performance in their specific applications.

The products described herein and this document are subject to specific legal disclaimers as set forth on the last page of this document, and at www.bourns.com/docs/legal/disclaimer.pdf.

PV Series - Low & Medium Voltage Plastic-Encapsulated Varistors **BOURNS®**

Soldering Pad Configuration

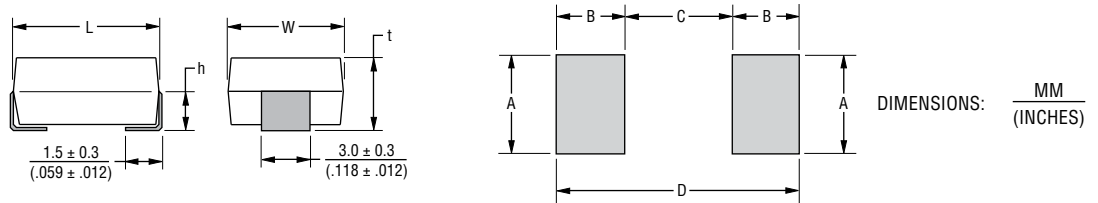

Size	Voltage Range (V)	Dimension							
		$h \pm \frac{0.3}{(.012)}$	$L \pm \frac{0.5}{(.020)}$	$W \pm \frac{0.4}{(.016)}$	$t \pm \frac{0.3}{(.012)}$	A	B	C	D
3225	11 to 150	$\frac{1.7}{(.066)}$	$\frac{8.0}{(.315)}$	$\frac{6.3}{(.248)}$	$\frac{3.4}{(.134)}$	$\frac{3.5}{(.138)}$	$\frac{2.9}{(.114)}$	$\frac{4.5}{(.177)}$	$\frac{10.3}{(.406)}$
3225	175 to 300	$\frac{2.3}{(.091)}$	$\frac{8.0}{(.315)}$	$\frac{6.3}{(.248)}$	$\frac{4.7}{(.185)}$	$\frac{3.5}{(.138)}$	$\frac{2.9}{(.114)}$	$\frac{4.5}{(.177)}$	$\frac{10.3}{(.406)}$
4032	11 to 300	$\frac{2.3}{(.091)}$	$\frac{10.0}{(.394)}$	$\frac{8.3}{(.327)}$	$\frac{4.7}{(.185)}$	$\frac{3.5}{(.138)}$	$\frac{2.9}{(.114)}$	$\frac{6.5}{(.256)}$	$\frac{12.3}{(.484)}$

Specifications are subject to change without notice.

Users should verify actual device performance in their specific applications.

The products described herein and this document are subject to specific legal disclaimers as set forth on the last page of this document, and at www.bourns.com/docs/legal/disclaimer.pdf.

PV Series - Low & Medium Voltage Plastic-Encapsulated Varistors **BOURNS®**

Packaging Specifications

Conforms to IEC Publication 286-3 Ed. 4: 2007-06

Tape

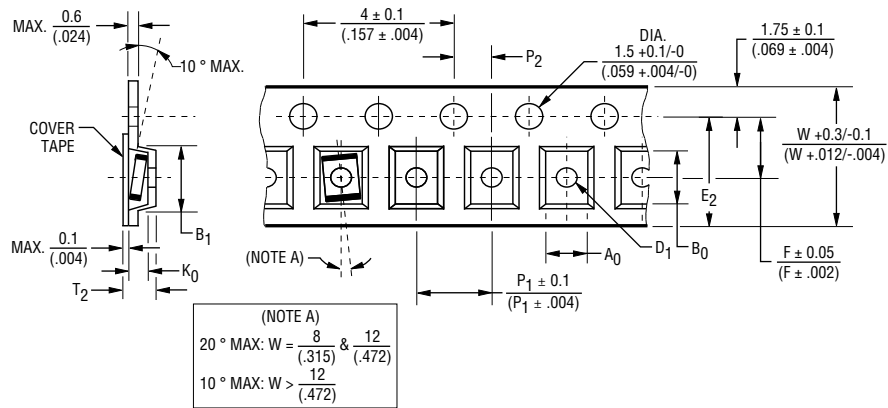

Reel

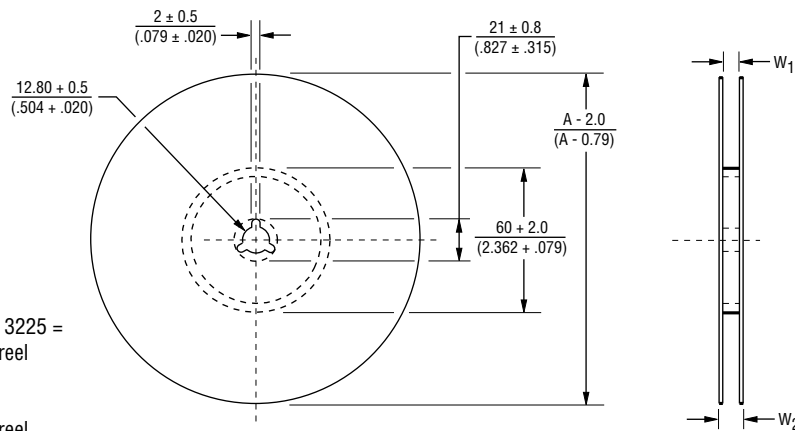

PV 11 K 3225 ~ PV 150 K 3225 =
1,500 pieces per 13-inch reel

All other models =
1,000 pieces per 13-inch reel

Dimension	Model Size	
	3225	4032
Size	$\frac{7}{(.276)}$	$\frac{8.6}{(.339)}$
A_0	$\frac{7.8}{(.307)}$	$\frac{10.8}{(.425)}$
B_0	$\frac{3.7}{(.146)}$	
K_0 MAX.	$\frac{12.1}{(.476)}$	
B_1 MAX.	$\frac{1.5}{(.059)}$	
D_1 DIA. MAX.	$\frac{14.25}{(.561)}$	
e_2	$\frac{12}{(.472)}$	

Dimension	Model Size	
	3225	4032
P_1	$\frac{7.5}{(.295)}$	
F	$\frac{16.0}{(.630)}$	
W	$\frac{9.5}{(.374)}$	
T_2 MAX.	$\frac{16.4 + 2}{(.646 + .079)}$	
W_1	$\frac{22.4}{(.882)}$	
W_2 MAX.	$\frac{15.9}{(.626)}^{10} \frac{19.4}{(.764)}$	
A DIA.	$\frac{330}{(12.992)}$	

DIMENSIONS: $\frac{\text{MM}}{\text{(INCHES)}}$

Specifications are subject to change without notice.

Users should verify actual device performance in their specific applications.

The products described herein and this document are subject to specific legal disclaimers as set forth on the last page of this document, and at www.bourns.com/docs/legal/disclaimer.pdf.

PV Series - Low & Medium Voltage Plastic-Encapsulated Varistors **BOURNS®**

Soldering Recommendations for SMD Components

Popular soldering techniques used for surface mounted components are Wave and Infrared Reflow processes. Both processes can be performed with Pb-containing or Pb-free solders. The termination options available for these soldering techniques are AgPd and Barrier Type End Terminations.

End Termination	Designation	Recommended and Suitable for	RoHS Compliant
Ag/Pd	PV Series...R1	Pb-containing soldering	Yes
Barrier Type End Termination	PV Series...N R1	Pb-containing and Pb-free soldering	Yes
NiSn End Termination	PV Series ...Ni R1	Pb-containing and Pb-free soldering	Yes

Wave Soldering

This process is generally associated with discrete components mounted on the underside of printed circuit boards, or for large top-side components with bottom-side mounting tabs to be attached, such as the frames of transformers, relays, connectors, etc. SMD varistors to be wave soldered are first glued to the circuit board, usually with an epoxy adhesive. When all components on the PCB have been positioned and an appropriate amount of time is allowed for adhesive curing, the completed assembly is then placed on a conveyor and run through a single, double wave process.

Infrared Reflow Soldering

These reflow processes are typically associated with top-side component placement. This technique utilizes a mixture of adhesive and solder compounds (and sometimes fluxes) that are blended into a paste. The paste is then screened onto PCB soldering pads specifically designed to accept a particular sized SMD component. The recommended solder paste wet layer thickness is 100 to 300 μm . Once the circuit board is fully populated with SMD components, it is placed in a reflow environment, where the paste is heated to slightly above its eutectic temperature. When the solder paste reflows, the SMD components are attached to the solder pads.

Solder Fluxes

Solder fluxes are generally applied to populated circuit boards to keep oxides from forming during the heating process and to facilitate the flowing of the solder. Solder fluxes can be either a part of the solder paste compound or separate materials, usually fluids.

Recommended fluxes are:

- non-activated (R) fluxes, whenever possible
- mildly activated (RMA) fluxes of class L3CN
- class ORLO

Activated (RA), water soluble or strong acidic fluxes with a chlorine content > 0.2 wt. % are NOT RECOMMENDED. The use of such fluxes could create high leakage current paths along the body of the varistor components.

When a flux is applied prior to wave soldering, it is important to completely dry any residual flux solvents prior to the soldering process.

Thermal Shock

To avoid the possibility of generating stresses in the varistor chip due to thermal shock, a preheat stage to within 100 °C of the peak soldering process temperature is recommended. Additionally, SMD varistors should not be subjected to a temperature gradient greater than 4 °C/sec., with an ideal gradient being 2 °C/sec. Peak temperatures should be controlled. Wave and Reflow soldering conditions for SMD varistors with Pb-containing solders are shown on the next page in Fig. 1 and 2 respectively, while Wave and Reflow soldering conditions for SMD varistors with Pb-free solders are shown in Fig. 1 and 3.

Whenever several different types of SMD components are being soldered, each having a specific soldering profile, the soldering profile with the least heat and the minimum amount of heating time is recommended. Once soldering has been completed, it is necessary to minimize the possibility of thermal shock by allowing the hot PCB to cool to less than 50 °C before cleaning.

Specifications are subject to change without notice.

Users should verify actual device performance in their specific applications.

The products described herein and this document are subject to specific legal disclaimers as set forth on the last page of this document, and at www.bourns.com/docs/legal/disclaimer.pdf.

PV Series - Low & Medium Voltage Plastic-Encapsulated Varistors **BOURNS®**

Soldering Recommendations for SMD Components (Continued)

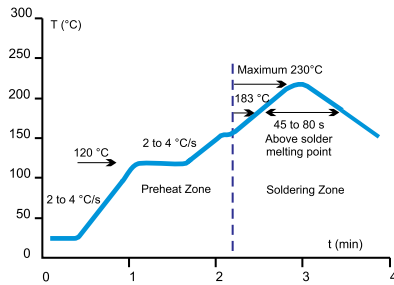

Fig. 1. Infrared Reflow Temperature Profile for Pb-containing Soldering

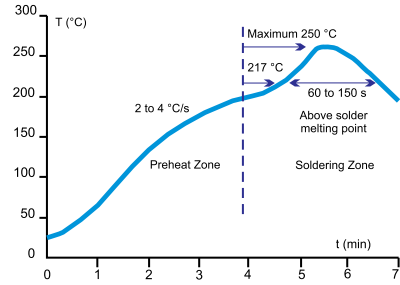

Fig. 2. Reflow Temperature Profile for Pb-free Soldering

Inspection Criteria

When Infrared Reflow processes are used, the inspection criteria to determine acceptable solder joints will depend on several key variables, principally termination material process profiles.

Solder Test and Retained Samples

Reflow soldering test based on J-STD-020D.1 and soldering test by dipping based on IEC 60068- 2 for Pb-free solders are performed on each production lot. Test results and accompanying samples are retained for a minimum of two (2) years. The solderability of a specific lot can be checked at any time within this period, should a customer require this information.

Rework Criteria - Soldering Iron

Unless absolutely necessary, the use of soldering irons is NOT recommended for reworking varistors encapsulated in plastic. If no other means of rework is available, the following criteria must be strictly followed:

- Do not allow the tip of the iron to directly contact the top of the plastic
- Do not exceed the following soldering iron specifications:

Output Power.....	30 Watts Maximum
Temperature of Soldering Iron Tip.....	280 °C Maximum
Soldering Time.....	10 Seconds Maximum

Storage Conditions

SMD varistors should be used within 1 year of purchase to avoid possible soldering problems caused by oxidized terminals. The storage environment should be controlled, with humidity less than 40 % and temperature between -25 and +45 °C. Varistor chips should always be stored in their original packaged unit.

PV Series - Low & Medium Voltage Plastic-Encapsulated Varistors **BOURNS®**

Reliability Testing Procedures

Varistor test procedures comply with CECC 42200, IEC 1051-1/2 (and AEC-Q200, if applicable). Test results are available upon customer request. Special tests can be performed upon customer request.

Reliability Parameter	Test	Tested According to	Condition to be Satisfied after Testing
AC/DC Bias Reliability	AC/DC Life Test	CECC 42200, Test 4.20 or IEC 1051-1, Test 4.20, AEC-Q200 Test 8 - 1000 h at UCT	$ \delta V_N (1 \text{ mA}) < 10 \%$
Pulse Current Capability	$I_{\max} 8/20 \mu\text{s}$	CECC 42200, Test C 2.1 or IEC 1051-1, Test 4.5 10 pulses in the same direction at 2 pulses per minute at maximum peak current for 10 pulses	$ \delta V_N (1 \text{ mA}) < 10 \%$ no visible damage
Pulse Energy Capability	$W_{\max} 10/1000 \mu\text{s}$	CECC 42200, Test C 2.1 or IEC 1051-1, Test 4.5 10 pulses in the same direction at 1 pulse every 2 minutes at maximum peak current for 10 pulses	$ \delta V_N (1 \text{ mA}) < 10 \%$ no visible damage
WLD Capability	WLD x 10	ISO 7637, Test pulse 5, 10 pulses at rate of 1 per minute	$ \delta V_N (1 \text{ mA}) < 15 \%$ no visible damage
V_{jump} Capability	V _{jump} 5 min.	Increase of supply voltage to $V \geq V_{\text{jump}}$ for 1 minute	$ \delta V_N (1 \text{ mA}) < 15 \%$ no visible damage
Environmental and Storage Reliability	Climatic Sequence	CECC 42200, Test 4.16 or IEC 1051-1, Test 4.17 a) Dry heat, 16h, UCT, Test Ba, IEC 68-2-2 b) Damp heat, cyclic, the first cycle: 55 °C, 93 % RH, 24 h, Test Db 68-2-4 c) Cold, LCT, 2 h, Test Aa, IEC 68-2-1 d) Damp heat cyclic, remaining 5 cycles: 55 °C, 93 % RH, 24 h/cycle, Test Bd, IEC 68-2-30	$ \delta V_N (1 \text{ mA}) < 10 \%$
	Thermal Shock	CECC 42200, Test 4.12, Test Na, IEC 68-2-14, AEC-Q200 Test 16, 5	$ \delta V_N (1 \text{ mA}) < 10 \%$ no visible damage
	Steady State Damp Heat	CECC 42200, Test 4.17, Test Ca, IEC 68-2-3, AEC-Q200 Test 6, 56 days, 40 °C, 93 % RH, AEC-Q200 Test 7: Bias, Rh, T all at 85.	$ \delta V_N (1 \text{ mA}) < 10 \%$
	Storage Test	IEC 68-2-2, Test Ba, AEC-Q200 Test 3, 1000 h at maximum storage temperature	$ \delta V_N (1 \text{ mA}) < 5 \%$

Continued on Next Page

Specifications are subject to change without notice.

Users should verify actual device performance in their specific applications.

The products described herein and this document are subject to specific legal disclaimers as set forth on the last page of this document, and at www.bourns.com/docs/legal/disclaimer.pdf.

PV Series - Low & Medium Voltage Plastic-Encapsulated Varistors **BOURNS®**

Reliability Testing Procedures (Continued)

Reliability Parameter	Test	Tested According to	Condition to be Satisfied after Testing
Mechanical Reliability	Solderability	CECC 42200, Test 4.10.1, Test Ta, IEC 68-2-20 solder bath and reflow method	Solderable at shipment and after 2 years of storage, criteria: >95% must be covered by solder for reflow meniscus
	Resistance to Soldering Heat	CECC 42200, Test 4.10.2, Test Tb, IEC 68-2-20 solder bath nad reflow method	$ \delta V_{\eta} (1 \text{ mA}) < 5 \%$
	Terminal Strength	JIS-C-6429, App. 1, 18N for 60 sec. - same for AEC-Q200 Test 22	No visual damage
	Board Flex	JIS-C-6429, App. 2, 2 mm min. AEC-Q200 test 21 - Board flex: 2 mm flex min.	$ \delta V_{\eta} (1 \text{ mA}) < 2 \%$ No visible damage
	Vibration	CECC 42200, Test 4.15, Test Fc, IEC 68-2-6, AEC-Q200 Test 14 Frequency range 10 to 55 Hz (AEC: 10-2000 Hz) Amplitude 0.75 m/s ² or 98 m/s ² (AEC: 5 g for 20 minutes) Total duration 6 h (3x2 h) (AEC: 12 cycles each of 3 directions) Waveshape - half sine	$ \delta V_{\eta} (1 \text{ mA}) < 2 \%$ No visible damage
	Mechanical Shock	CECC 42200, Test 4.14, Test Ea, IEC 68-2-27, AEC-Q200 Test 13. Acceleration = 490 m/s ² (AEC: MIL-STD-202-Method 213), Pulse duration = 11 ms, Waveshape - half sine; Number of shocks = 3x6	$ \delta V_{\eta} (1 \text{ mA}) < 10 \%$ No visible damage
Electrical Transient Conduction	ISO-7637-1 Pulses	AEC-Q200 Test 30: Test pulses 1 to 3. Also other pulses - freestyle.	$ \delta V_{\eta} (1 \text{ mA}) < 10 \%$ No visible damage

Specifications are subject to change without notice.

Users should verify actual device performance in their specific applications.

The products described herein and this document are subject to specific legal disclaimers as set forth on the last page of this document, and at www.bourns.com/docs/legal/disclaimer.pdf.

PV Series - Low & Medium Voltage Plastic-Encapsulated Varistors **BOURNS**[®]

Terminology

Term	Symbol	Definition
Rated AC Voltage	V_{rms}	Maximum continuous sinusoidal AC voltage (<5 % total harmonic distortion) which may be applied to the component under continuous operation conditions at +25 °C
Rated DC Voltage	V_{dc}	Maximum continuous DC voltage (<5 % ripple) which may be applied to the component under continuous operating conditions at +25 °C
Supply Voltage	V	The voltage by which the system is designated and to which certain operating characteristics of the system are referred; $V_{rms} = 1.1 \times V$
Leakage Current	I_{dc}	The current passing through the varistor at V_{dc} and at +25 °C or at any other specified temperature
Varistor Voltage	V_n	Voltage across the varistor measured at a given reference current (I_n)
Reference Current	I_n	Reference current = 1 mA DC
Clamping Voltage	V_c	The peak voltage developed across the varistor under standard atmospheric conditions, when passing an 8/20 μs class current pulse
Protection Level		
Class Current	I_c	A peak value of current which is 1/10 of the maximum peak current for 100 pulses at two per minute for the 8/20 μs pulse
Voltage Clamping Ratio	V_c/V_{app}	A figure of merit measure of the varistor clamping effectiveness as defined by the symbols V_c/V_{app} , where ($V_{app} = V_{rms}$ or V_{dc})
Jump Start Transient	V_{jump}	The jump start transient results from the temporary application of an overvoltage in excess of the rated battery voltage. The circuit power supply may be subjected to a temporary overvoltage condition due to the voltage regulation failing or it may be deliberately generated when it becomes necessary to boost start the car.
Rated Single Pulse	W_{max}	Energy which may be dissipated for a single 10/1000 μs pulse of a maximum rated current, with rated AC voltage or rated DC voltage also applied, without causing device failure
Transient Energy		
Load Dump Transient	WLD	Load Dump is a transient which occurs in automotive environments. It is an exponentially decaying positive voltage which occurs in the event of a battery disconnect while the alternator is still generating charging current with other loads remaining on the alternator circuit at the time of battery disconnect.
Rated Peak Single Pulse	I_{max}	Maximum peak current which may be applied for a single 8/20 μs pulse, with rated line voltage also applied, without causing device failure
Transient Current		
Rated Transient Average	P	Maximum average power which may be dissipated due to a group of pulses occurring within a specified isolated time period, without causing device failure at 25 °C
Power Dissipation		
Capacitance	C	Capacitance between two terminals of the varistor measured @ 1 kHz
Non-linearity Exponent	α	A measure of varistor nonlinearity between two given operating currents, I_n and I_1 as described by $I = k V \exp(a)$, where: <ul style="list-style-type: none"> - k is a device constant, - $I_1 < I < I_n$ and - $a \log(I_1/I_n) / \log(V_1/V_n) = 1 / \log(V_1/V_n)$, where: - I_r is reference current (1 mA) and V_n is varistor voltage - $I_1 = 10 I_n$, V_1 is the voltage measured at I_1
Response Time	t_r	The time lag between application of a surge and varistor's "turn-on" conduction action
Varistor Voltage Temperature	TC	$(V_n @ 85 \text{ °C} - V_n @ 25 \text{ °C}) / (V_n @ 25 \text{ °C}) \times 60 \text{ °C} \times 100$
Coefficient		
Insulation Resistance	IR	Minimum resistance between shorted terminals and varistor surface
Isolation Voltage		The maximum peak voltage which may be applied under continuous operating conditions between the varistor terminations and any conducting mounting surface
Operating Temperature		The range of ambient temperature for which the varistor is designed to operate continuously as defined by the temperature limits of its climatic category
Climatic Category	LCT/UCT/DHD	LCT & UCT = Lower and Upper Category Temperature - the minimum and maximum ambient temperatures for which a varistor has been designed to operate continuously. DHD = Dump Heat Test Duration
Storage Temperature		Storage temperature range without voltage applied
Current/Energy Derating		Derating of maximum values when operated above UCT

REV. C 06/20

Specifications are subject to change without notice.

Users should verify actual device performance in their specific applications.

The products described herein and this document are subject to specific legal disclaimers as set forth on the last page of this document, and at www.bourns.com/docs/legal/disclaimer.pdf.

This legal disclaimer applies to purchasers and users of Bourns® products manufactured by or on behalf of Bourns, Inc. and its affiliates (collectively, “Bourns”).

Unless otherwise expressly indicated in writing, Bourns® products and data sheets relating thereto are subject to change without notice. Users should check for and obtain the latest relevant information and verify that such information is current and complete before placing orders for Bourns® products.

The characteristics and parameters of a Bourns® product set forth in its data sheet are based on laboratory conditions, and statements regarding the suitability of products for certain types of applications are based on Bourns’ knowledge of typical requirements in generic applications. The characteristics and parameters of a Bourns® product in a user application may vary from the data sheet characteristics and parameters due to (i) the combination of the Bourns® product with other components in the user’s application, or (ii) the environment of the user application itself. The characteristics and parameters of a Bourns® product also can and do vary in different applications and actual performance may vary over time. Users should always verify the actual performance of the Bourns® product in their specific devices and applications, and make their own independent judgments regarding the amount of additional test margin to design into their device or application to compensate for differences between laboratory and real world conditions.

Unless Bourns has explicitly designated an individual Bourns® product as meeting the requirements of a particular industry standard (e.g., ISO/TS 16949) or a particular qualification (e.g., UL listed or recognized), Bourns is not responsible for any failure of an individual Bourns® product to meet the requirements of such industry standard or particular qualification. Users of Bourns® products are responsible for ensuring compliance with safety-related requirements and standards applicable to their devices or applications.

Bourns® products are not recommended, authorized or intended for use in nuclear, lifesaving, life-critical or life-sustaining applications, nor in any other applications where failure or malfunction may result in personal injury, death, or severe property or environmental damage. Unless expressly and specifically approved in writing by two authorized Bourns representatives on a case-by-case basis, use of any Bourns® products in such unauthorized applications might not be safe and thus is at the user’s sole risk. Life-critical applications include devices identified by the U.S. Food and Drug Administration as Class III devices and generally equivalent classifications outside of the United States.

Bourns expressly identifies those Bourns® standard products that are suitable for use in automotive applications on such products’ data sheets in the section entitled “Applications.” Unless expressly and specifically approved in writing by two authorized Bourns representatives on a case-by-case basis, use of any other Bourns® standard products in an automotive application might not be safe and thus is not recommended, authorized or intended and is at the user’s sole risk. If Bourns expressly identifies a sub-category of automotive application in the data sheet for its standard products (such as infotainment or lighting), such identification means that Bourns has reviewed its standard product and has determined that if such Bourns® standard product is considered for potential use in automotive applications, it should only be used in such sub-category of automotive applications. Any reference to Bourns® standard product in the data sheet as compliant with the AEC-Q standard or “automotive grade” does not by itself mean that Bourns has approved such product for use in an automotive application.

Bourns® standard products are not tested to comply with United States Federal Aviation Administration standards generally or any other generally equivalent governmental organization standard applicable to products designed or manufactured for use in aircraft or space applications. Bourns expressly identifies Bourns® standard products that are suitable for use in aircraft or space applications on such products’ data sheets in the section entitled “Applications.” Unless expressly and specifically approved in writing by two authorized Bourns representatives on a case-by-case basis, use of any other Bourns® standard product in an aircraft or space application might not be safe and thus is not recommended, authorized or intended and is at the user’s sole risk.

The use and level of testing applicable to Bourns® custom products shall be negotiated on a case-by-case basis by Bourns and the user for which such Bourns® custom products are specially designed. Absent a written agreement between Bourns and the user regarding the use and level of such testing, the above provisions applicable to Bourns® standard products shall also apply to such Bourns® custom products.

Users shall not sell, transfer, export or re-export any Bourns® products or technology for use in activities which involve the design, development, production, use or stockpiling of nuclear, chemical or biological weapons or missiles, nor shall they use Bourns® products or technology in any facility which engages in activities relating to such devices. The foregoing restrictions apply to all uses and applications that violate national or international prohibitions, including embargos or international regulations. Further, Bourns® products and Bourns technology and technical data may not under any circumstance be exported or re-exported to countries subject to international sanctions or embargoes. Bourns® products may not, without prior authorization from Bourns and/or the U.S. Government, be resold, transferred, or re-exported to any party not eligible to receive U.S. commodities, software, and technical data.

To the maximum extent permitted by applicable law, Bourns disclaims (i) any and all liability for special, punitive, consequential, incidental or indirect damages or lost revenues or lost profits, and (ii) any and all implied warranties, including implied warranties of fitness for particular purpose, non-infringement and merchantability.

For your convenience, copies of this Legal Disclaimer Notice with German, Spanish, Japanese, Traditional Chinese and Simplified Chinese bilingual versions are available at:

Web Page: <http://www.bourns.com/legal/disclaimers-terms-and-policies>

PDF: <http://www.bourns.com/docs/Legal/disclaimer.pdf>

Looking for pricing, stock, or lifecycle information?

Click below to explore more details on WIN SOURCE:

 [View PV95K4032R2 on WIN SOURCE](#)

 [Bourns Inc. Information](#)

Optimize Your Supply Chain with WIN SOURCE Solutions

-  Global Sourcing Solution
-  Obsolete Management
-  Cost Control Management
-  Shortage Management
-  Alternative Solution
-  Excess Inventory Management