



# 55GN01MA

## RF Transistor 10V, 70mA, $f_T=5.5\text{GHz}$ , NPN Single MCP

ON Semiconductor®

<http://onsemi.com>

### Features

- High cut-off frequency :  $f_T=5.5\text{GHz}$  typ
- High gain :  $|S_{21e}|^2=10\text{dB}$  typ ( $f=1\text{GHz}$ )

### Specifications

Absolute Maximum Ratings at  $T_a=25^\circ\text{C}$

Parameter	Symbol	Conditions	Ratings	Unit
Collector-to-Base Voltage	$V_{CBO}$		20	V
Collector-to-Emitter Voltage	$V_{CEO}$		10	V
Emitter-to-Base Voltage	$V_{EBO}$		3	V
Collector Current	$I_C$		70	mA
Collector Dissipation	$P_C$	When mounted on ceramic substrate (250mm <sup>2</sup> ×0.8mm)	400	mW
Junction Temperature	$T_j$		150	°C
Storage Temperature	$T_{stg}$		-55 to +150	°C

Stresses exceeding Maximum Ratings may damage the device. Maximum Ratings are stress ratings only. Functional operation above the Recommended Operating Conditions is not implied. Extended exposure to stresses above the Recommended Operating Conditions may affect device reliability.

### Package Dimensions

unit : mm (typ)

7023A-009

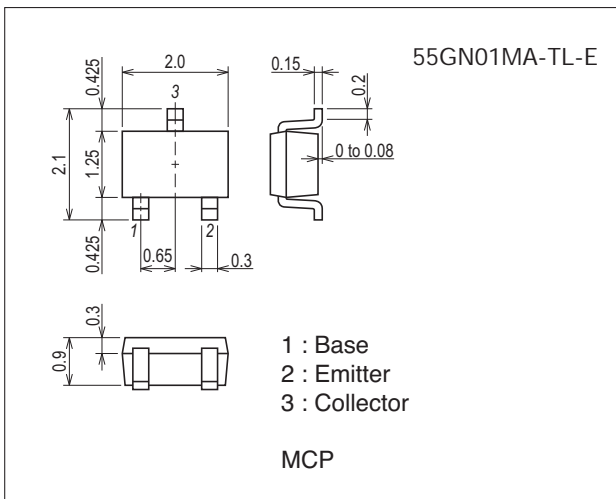

### Product & Package Information

- Package : MCP
- JEITA, JEDEC : SC-70, SOT-323
- Minimum Packing Quantity : 3,000 pcs./reel

### Packing Type: TL

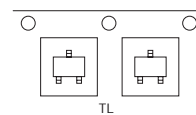

### Marking

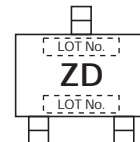

### Electrical Connection

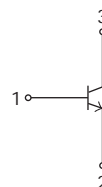

# 55GN01MA

## Electrical Characteristics at Ta=25°C

Parameter	Symbol	Conditions	Ratings			Unit
			min	typ	max	
Collector Cutoff Current	$I_{CBO}$	$V_{CB}=10V, I_E=0A$			0.1	$\mu A$
Emitter Cutoff Current	$I_{EBO}$	$V_{EB}=2V, I_C=0A$			1	$\mu A$
DC Current Gain	$h_{FE}$	$V_{CE}=5V, I_C=10mA$	100		180	
Gain-Bandwidth Product	$f_{T1}$	$V_{CE}=3V, I_C=5mA$	3.0	4.5		GHz
	$f_{T2}$	$V_{CE}=5V, I_C=20mA$		5.5		GHz
Output Capacitance	$C_{ob}$	$V_{CB}=10V, f=1MHz$		1.0	1.3	pF
Reverse Transfer Capacitance	$C_{re}$			0.6		pF
Forward Transfer Gain	$ S_{21e} ^2$	$V_{CE}=5V, I_C=20mA, f=1GHz$	7	10		dB
Noise Figure	NF	$V_{CE}=3V, I_C=5mA, f=1GHz, Z_O=50\Omega$		1.9	2.8	dB

## Ordering Information

Device	Package	Shipping	memo
55GN01MA-TL-E	MCP	3,000pcs./reel	Pb Free

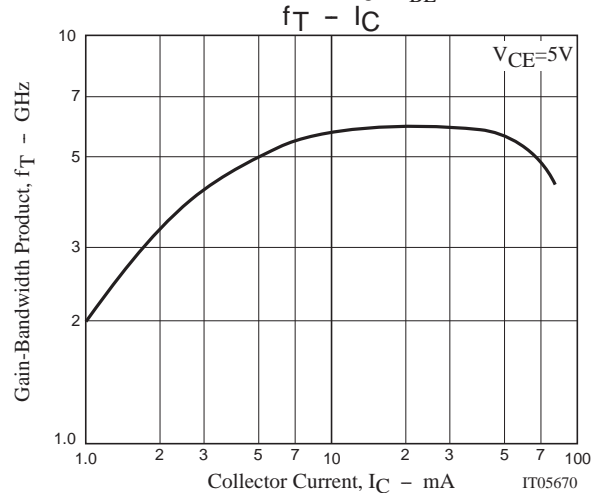
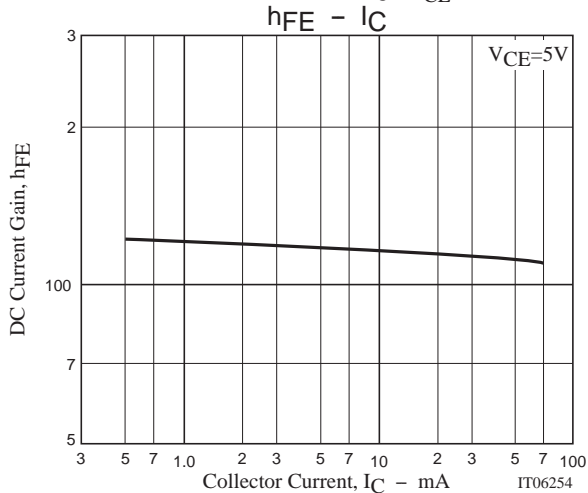
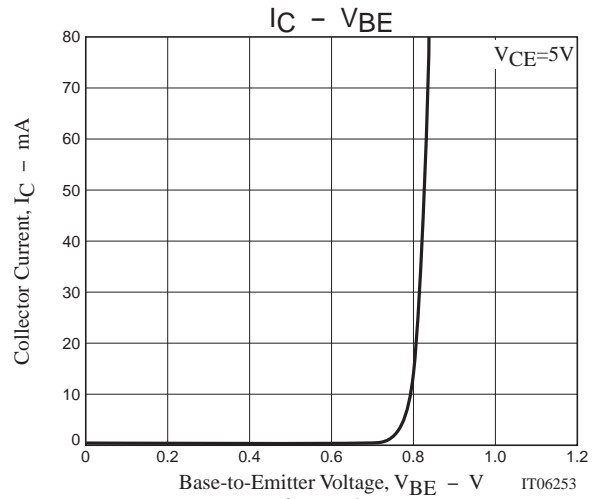
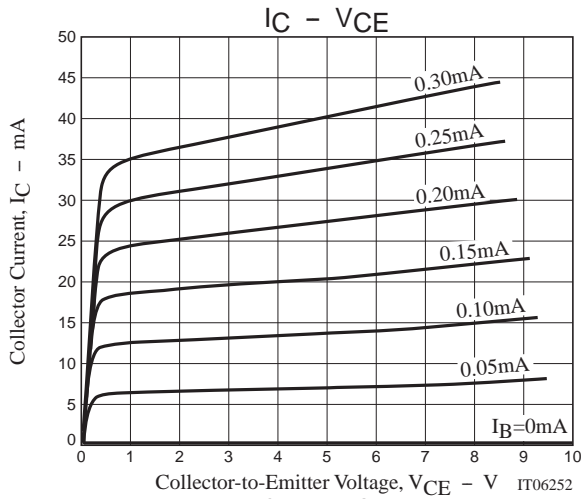

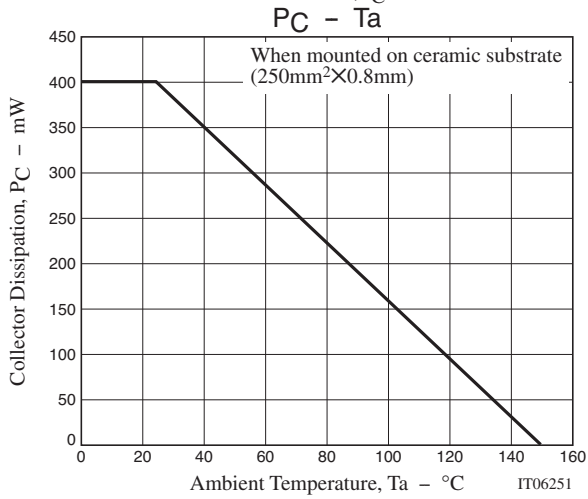
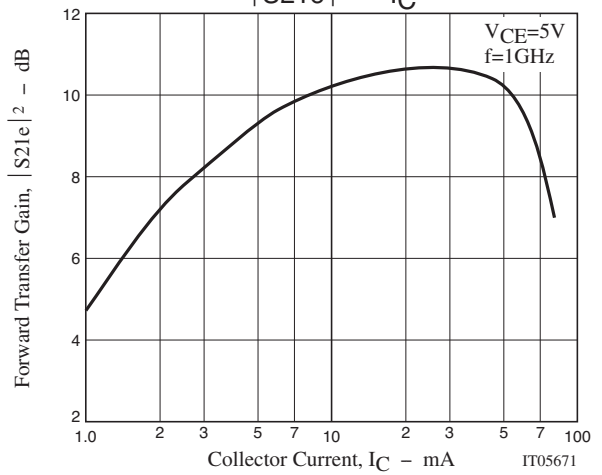
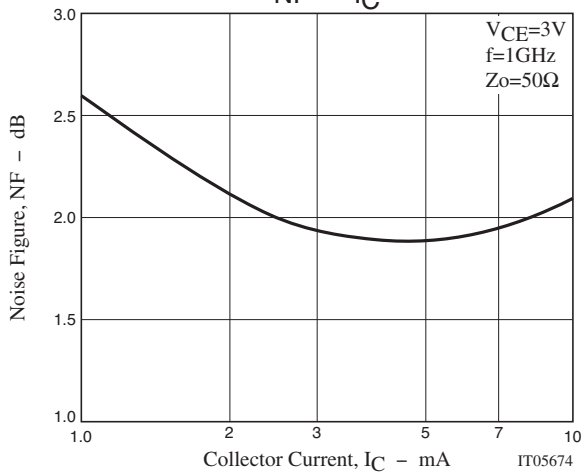
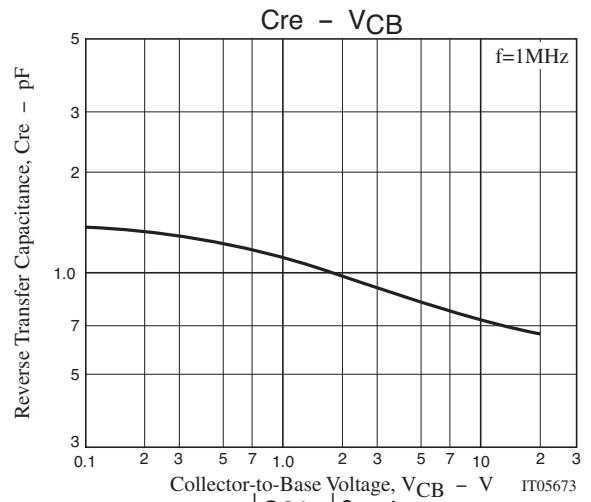
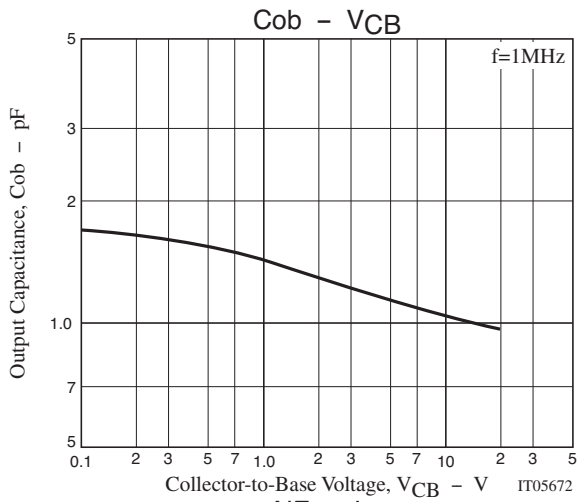

## 55GN01MA

### S Parameters (Common emitter)

$V_{CE}=5V, I_C=5mA, Z_O=50\Omega$

Freq(MHz)	S11	$\angle S11$	S21	$\angle S21$	S12	$\angle S12$	S22	$\angle S22$
100	0.830	-43.97	13.127	147.99	0.038	67.23	0.872	-22.91
200	0.694	-77.62	10.294	125.90	0.060	54.39	0.700	-35.46
400	0.540	-117.92	6.419	101.76	0.081	48.13	0.501	-44.05
600	0.481	-140.06	4.518	88.76	0.095	49.82	0.424	-46.75
800	0.461	-155.07	3.503	78.58	0.111	52.28	0.393	-49.83
1000	0.451	-165.52	2.877	70.19	0.128	54.96	0.381	-53.19
1200	0.445	-174.34	2.452	62.66	0.146	56.81	0.375	-57.17
1400	0.445	178.04	2.147	56.03	0.168	58.15	0.377	-61.74
1600	0.445	171.32	1.918	49.61	0.189	58.43	0.382	-66.69
1800	0.445	164.86	1.737	43.71	0.211	58.38	0.386	-71.55
2000	0.449	158.60	1.595	38.11	0.237	58.17	0.390	-76.75
2200	0.452	152.58	1.467	32.97	0.265	57.40	0.396	-82.35
2400	0.450	146.68	1.363	28.29	0.289	56.02	0.399	-87.23
2600	0.453	141.54	1.274	24.12	0.315	55.05	0.402	-92.59
2800	0.462	136.46	1.198	20.67	0.346	53.73	0.407	-98.30
3000	0.472	131.80	1.143	17.49	0.377	51.74	0.405	-104.52

$V_{CE}=5V, I_C=10mA, Z_O=50\Omega$

Freq(MHz)	S11	$\angle S11$	S21	$\angle S21$	S12	$\angle S12$	S22	$\angle S22$
100	0.684	-64.81	20.386	135.46	0.033	61.46	0.746	-32.56
200	0.537	-103.63	13.552	113.26	0.046	54.93	0.530	-42.92
400	0.442	-139.55	7.523	93.84	0.066	56.90	0.365	-45.97
600	0.418	-156.47	5.145	83.67	0.087	60.27	0.318	-46.89
800	0.415	-167.86	3.934	75.21	0.109	62.42	0.302	-49.45
1000	0.412	-175.67	3.211	67.90	0.131	63.30	0.299	-52.76
1200	0.411	177.29	2.725	61.28	0.155	63.24	0.299	-56.97
1400	0.415	171.08	2.375	55.21	0.179	62.62	0.304	-61.81
1600	0.418	165.63	2.121	49.25	0.203	61.52	0.311	-66.89
1800	0.419	159.97	1.918	43.74	0.228	60.43	0.315	-71.68
2000	0.424	154.44	1.760	38.40	0.254	58.94	0.320	-76.83
2200	0.429	148.97	1.619	33.44	0.281	57.20	0.326	-82.56
2400	0.427	143.60	1.506	28.88	0.304	55.14	0.329	-86.87
2600	0.431	139.13	1.408	24.76	0.329	53.64	0.334	-92.16
2800	0.441	134.54	1.327	21.16	0.358	51.96	0.339	-97.67
3000	0.451	130.40	1.266	17.89	0.386	49.84	0.338	-103.91

$V_{CE}=5V, I_C=20mA, Z_O=50\Omega$

Freq(MHz)	S11	$\angle S11$	S21	$\angle S21$	S12	$\angle S12$	S22	$\angle S22$
100	0.527	-90.16	26.224	123.28	0.026	59.94	0.598	-40.43
200	0.438	-127.59	15.340	104.33	0.037	60.44	0.396	-45.63
400	0.399	-155.68	8.065	89.00	0.060	65.69	0.282	-44.29
600	0.393	-167.56	5.453	80.60	0.084	67.76	0.256	-44.57
800	0.397	-176.18	4.149	73.14	0.109	68.31	0.250	-47.52
1000	0.398	177.84	3.379	66.41	0.134	67.71	0.252	-51.39
1200	0.401	172.13	2.862	60.19	0.159	66.77	0.255	-55.96
1400	0.406	166.95	2.491	54.45	0.186	65.32	0.262	-61.04
1600	0.411	162.22	2.222	48.82	0.210	63.20	0.270	-66.49
1800	0.414	157.06	2.008	43.51	0.235	61.52	0.275	-71.29
2000	0.419	152.07	1.840	38.32	0.261	59.51	0.282	-76.53
2200	0.425	146.91	1.693	33.45	0.288	57.59	0.289	-82.27
2400	0.424	141.87	1.574	29.00	0.312	55.28	0.293	-86.65
2600	0.429	137.61	1.472	24.92	0.336	53.54	0.298	-91.76
2800	0.438	133.38	1.387	21.39	0.365	51.63	0.304	-97.07
3000	0.449	129.47	1.321	18.07	0.392	49.39	0.303	-103.60

## 55GN01MA

### S Parameters (Common emitter)

$V_{CE}=5V$ ,  $I_C=30mA$ ,  $Z_O=50\Omega$

Freq(MHz)	S11	$\angle S11$	S21	$\angle S21$	S12	$\angle S12$	S22	$\angle S22$
100	0.461	-105.76	28.111	117.59	0.023	60.62	0.521	-42.88
200	0.412	-139.73	15.717	100.76	0.034	64.40	0.344	-44.71
400	0.393	-162.64	8.133	87.05	0.058	69.84	0.255	-41.81
600	0.394	-172.24	5.483	79.25	0.084	70.67	0.237	-42.42
800	0.400	-179.58	4.169	72.10	0.110	70.59	0.235	-45.80
1000	0.401	175.18	3.392	65.52	0.135	69.45	0.239	-49.94
1200	0.405	169.95	2.870	59.47	0.161	68.00	0.244	-54.75
1400	0.412	165.14	2.496	53.81	0.187	66.24	0.252	-60.09
1600	0.417	160.67	2.226	48.20	0.212	64.03	0.260	-65.80
1800	0.422	155.72	2.010	42.96	0.237	62.33	0.267	-70.89
2000	0.428	150.84	1.841	37.78	0.263	60.20	0.275	-76.12
2200	0.434	145.91	1.692	32.98	0.291	58.16	0.282	-81.97
2400	0.433	140.96	1.574	28.60	0.314	55.69	0.286	-86.52
2600	0.438	136.73	1.469	24.51	0.339	53.89	0.291	-91.68
2800	0.447	132.49	1.384	21.02	0.367	52.12	0.298	-97.10
3000	0.459	128.65	1.319	17.72	0.395	49.72	0.298	-103.63

# 55GN01MA

## Embossed Taping Specification

55GN01MA-TL-E

### 1. Packing Format

Package Name	Carrier Tape Type	Maximum Number of devices contained (pcs)			Packing format	
		Reel	Inner box	Outer box	Inner BOX (C-1)	Outer BOX (A-7)
MCP	MCP	3,000	15,000	90,000	5 reels contained Dimensions:mm (external) 183×72×185	6 inner boxes contained Dimensions:mm (external) 440×195×210

#### Packing method

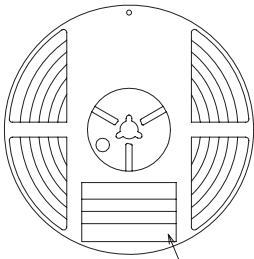

Reel label

Type No.  
LOT No.  
Quantity  
Origin

Reel label, Inner box label  
(unit: mm)

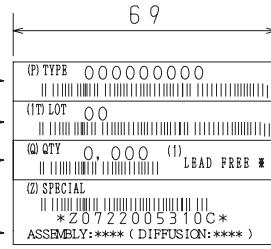

Outer box label

It is a label at the time of factory shipments.  
The form of a label may change in physical distribution process.

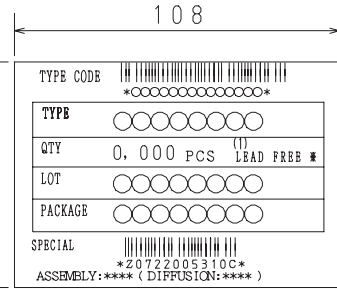

NOTE (1)

The LEAD FREE \* description shows that the surface treatment of the terminal is lead free.

Label	JEITA Phase
LEAD FREE 3	JEITA Phase 3A
LEAD FREE 4	JEITA Phase 3

### 2. Taping configuration

#### 2-1. Carrier tape size (unit:mm)

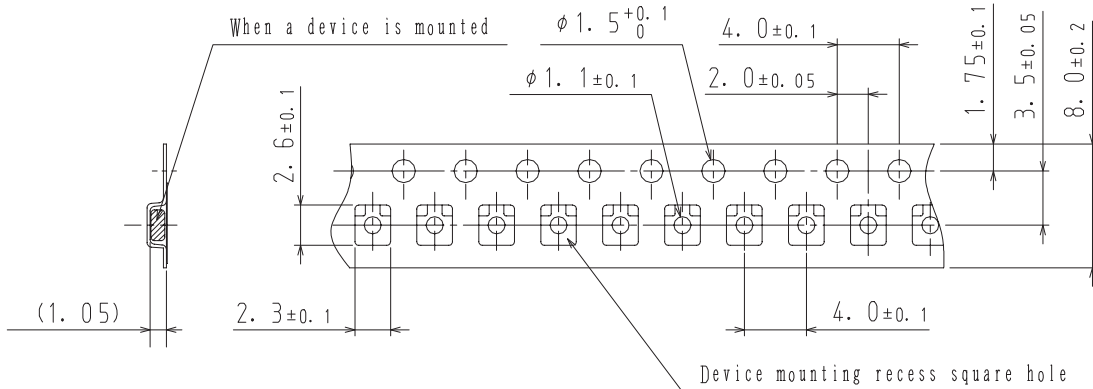

#### 2-2. Device placement direction

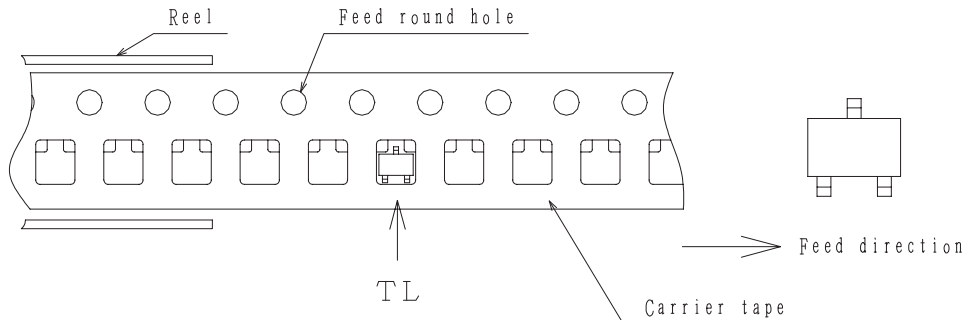

Those with one electrode terminal on the feed hole side.....TL

# 55GN01MA

## Outline Drawing 55GN01MA-TL-E

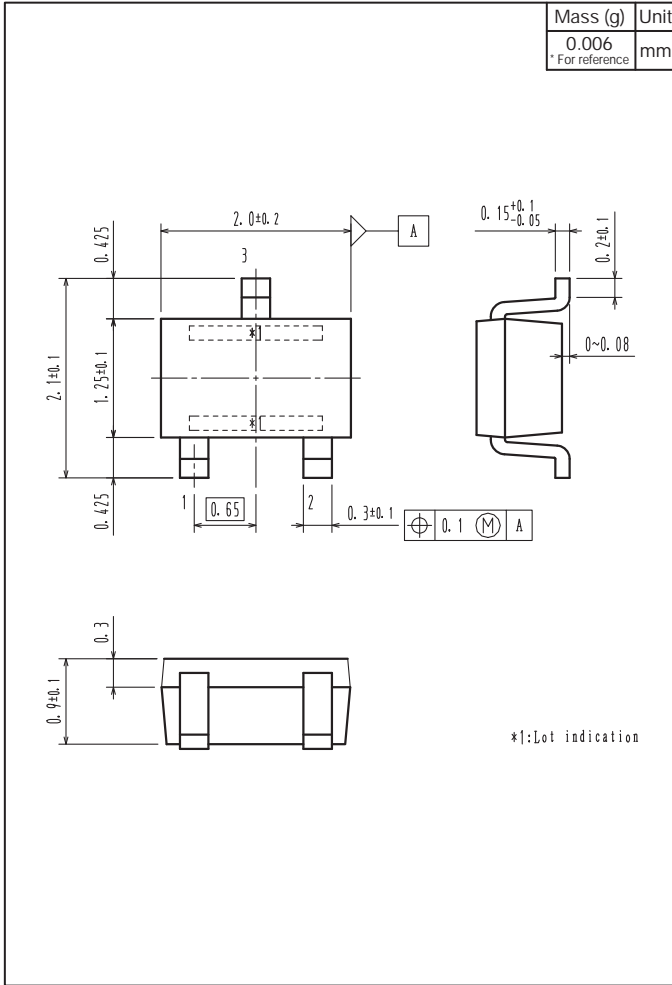

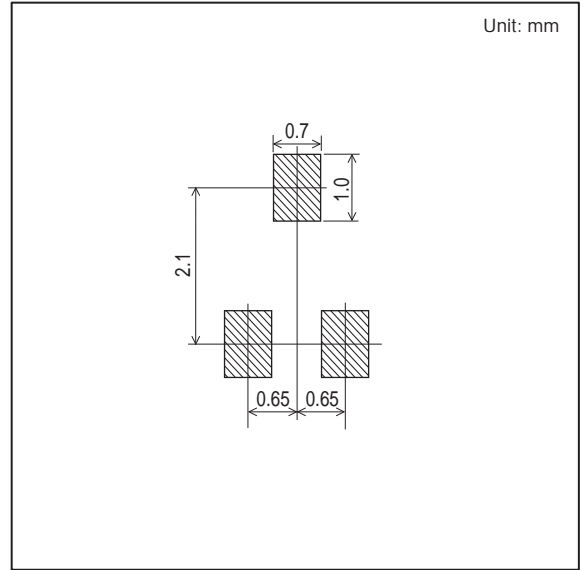

## Land Pattern Example





ON Semiconductor and the ON logo are registered trademarks of Semiconductor Components Industries, LLC (SCILLC). SCILLC owns the rights to a number of patents, trademarks, copyrights, trade secrets, and other intellectual property. A listing of SCILLC's product/patent coverage may be accessed at [www.onsemi.com/site/pdf/Patent-Marking.pdf](http://www.onsemi.com/site/pdf/Patent-Marking.pdf). SCILLC reserves the right to make changes without further notice to any products herein. SCILLC makes no warranty, representation or guarantee regarding the suitability of its products for any particular purpose, nor does SCILLC assume any liability arising out of the application or use of any product or circuit, and specifically disclaims any and all liability, including without limitation special, consequential or incidental damages. "Typical" parameters which may be provided in SCILLC data sheets and/or specifications can and do vary in different applications and actual performance may vary over time. All operating parameters, including "Typicals" must be validated for each customer application by customer's technical experts. SCILLC does not convey any license under its patent rights nor the rights of others. SCILLC products are not designed, intended, or authorized for use as components in systems intended for surgical implant into the body, or other applications intended to support or sustain life, or for any other application in which the failure of the SCILLC product could create a situation where personal injury or death may occur. Should Buyer purchase or use SCILLC products for any such unintended or unauthorized application, Buyer shall indemnify and hold SCILLC and its officers, employees, subsidiaries, affiliates, and distributors harmless against all claims, costs, damages, and expenses, and reasonable attorney fees arising out of, directly or indirectly, any claim of personal injury or death associated with such unintended or unauthorized use, even if such claim alleges that SCILLC was negligent regarding the design or manufacture of the part. SCILLC is an Equal Opportunity/Affirmative Action Employer. This literature is subject to all applicable copyright laws and is not for resale in any manner.

## Looking for pricing, stock, or lifecycle information?

Click below to explore more details on WIN SOURCE:

-  [View 55GN01MA-TL-E on WIN SOURCE](#)
-  [ON Semiconductor](#) Information

## Optimize Your Supply Chain with WIN SOURCE Solutions

-  Global Sourcing Solution
-  Obsolete Management
-  Cost Control Management
-  Shortage Management
-  Alternative Solution
-  Excess Inventory Management