



# 5LN01C

## N-Channel Small Signal MOSFET 50V, 0.1A, 7.8Ω, Single CP

ON Semiconductor®

<http://onsemi.com>

### Features

- Low ON-resistance
- Ultrahigh-speed switching
- 2.5V drive

### Specifications

#### Absolute Maximum Ratings at Ta=25°C

Parameter	Symbol	Conditions	Ratings	Unit
Drain to Source Voltage	V <sub>DSS</sub>		50	V
Gate to Source Voltage	V <sub>GSS</sub>		±10	V
Drain Current (DC)	I <sub>D</sub>		0.1	A
Drain Current (Pulse)	I <sub>DP</sub>	PW≤10μs, duty cycle≤1%	0.4	A
Allowable Power Dissipation	P <sub>D</sub>		0.25	W
Channel Temperature	T <sub>ch</sub>		150	°C
Storage Temperature	T <sub>stg</sub>		-55 to +150	°C

This product is designed to "ESD immunity < 200V\*\*", so please take care when handling.

\* Machine Model

Stresses exceeding Maximum Ratings may damage the device. Maximum Ratings are stress ratings only. Functional operation above the Recommended Operating Conditions is not implied. Extended exposure to stresses above the Recommended Operating Conditions may affect device reliability.

### Package Dimensions

unit : mm (typ)

7013A-013

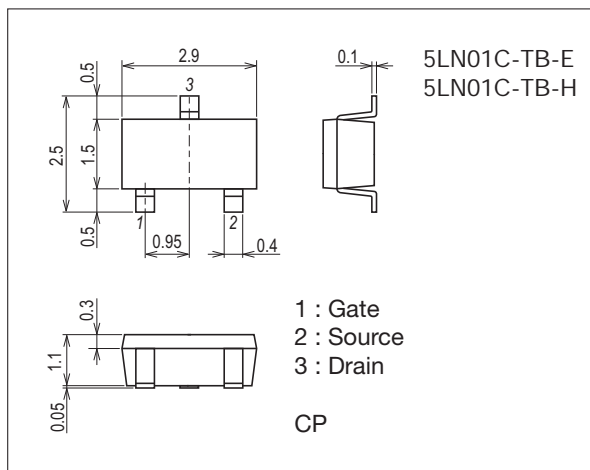

### Ordering & Package Information

Device	Package	Shipping	memo
5LN01C-TB-E	CP SC-59, TO-236, SOT-23, TO-236AB	3,000pcs./ reel	Pb-Free
5LN01C-TB-H	CP SC-59, TO-236, SOT-23, TO-236AB	3,000pcs./ reel	Pb-Free and Halogen Free

### Packing Type: TB

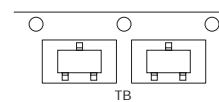

### Marking

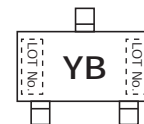

### Electrical Connection

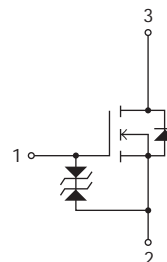

# 5LN01C

## Electrical Characteristics at $T_a=25^\circ\text{C}$

Parameter	Symbol	Conditions	Ratings			Unit
			min	typ	max	
Drain to Source Breakdown Voltage	$V(\text{BR})\text{DSS}$	$I_D=1\text{mA}, V_{GS}=0\text{V}$	50			V
Zero-Gate Voltage Drain Current	$I_{\text{DSS}}$	$V_{\text{DS}}=50\text{V}, V_{\text{GS}}=0\text{V}$			1	$\mu\text{A}$
Gate to Source Leakage Current	$I_{\text{GSS}}$	$V_{\text{GS}}=\pm 8\text{V}, V_{\text{DS}}=0\text{V}$			$\pm 10$	$\mu\text{A}$
Cutoff Voltage	$V_{\text{GS(off)}}$	$V_{\text{DS}}=10\text{V}, I_D=100\mu\text{A}$	0.4		1.3	V
Forward Transfer Admittance	$ y_{fs} $	$V_{\text{DS}}=10\text{V}, I_D=50\text{mA}$	0.13	0.18		S
Static Drain to Source On-State Resistance	$R_{\text{DS(on)1}}$	$I_D=50\text{mA}, V_{\text{GS}}=4\text{V}$		6	7.8	$\Omega$
	$R_{\text{DS(on)2}}$	$I_D=30\text{mA}, V_{\text{GS}}=2.5\text{V}$		7.1	9.9	$\Omega$
	$R_{\text{DS(on)3}}$	$I_D=10\text{mA}, V_{\text{GS}}=1.5\text{V}$		10	20	$\Omega$
Input Capacitance	$C_{\text{iss}}$	$V_{\text{DS}}=10\text{V}, f=1\text{MHz}$		6.6		pF
Output Capacitance	$C_{\text{oss}}$			4.7		pF
Reverse Transfer Capacitance	$C_{\text{rss}}$			1.7		pF
Turn-ON Delay Time	$t_{\text{d(on)}}$		See specified Test Circuit.		18	
Rise Time	$t_{\text{r}}$			42		ns
Turn-OFF Delay Time	$t_{\text{d(off)}}$			190		ns
Fall Time	$t_{\text{f}}$			105		ns
Total Gate Charge	$Q_{\text{g}}$	$V_{\text{DS}}=10\text{V}, V_{\text{GS}}=10\text{V}, I_D=100\text{mA}$			1.57	
Gate to Source Charge	$Q_{\text{gs}}$			0.20		nC
Gate to Drain "Miller" Charge	$Q_{\text{gd}}$			0.32		nC
Diode Forward Voltage	$V_{\text{SD}}$	$I_S=100\text{mA}, V_{\text{GS}}=0\text{V}$		0.85	1.2	V

## Switching Time Test Circuit

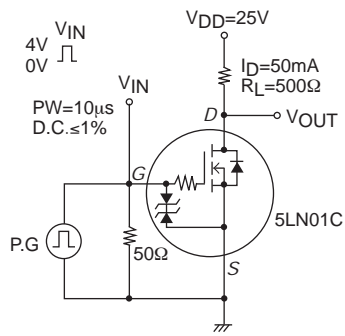

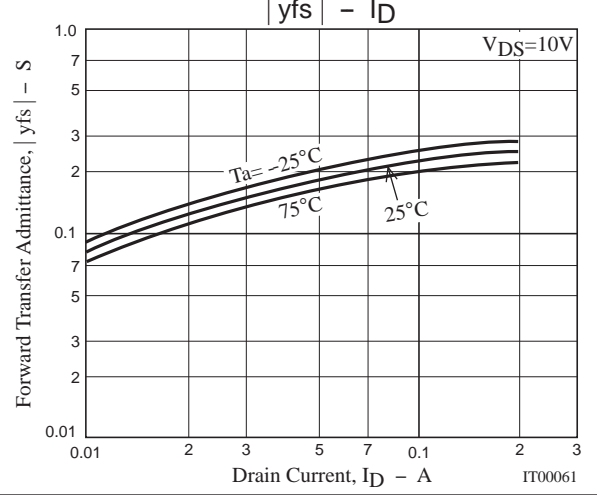
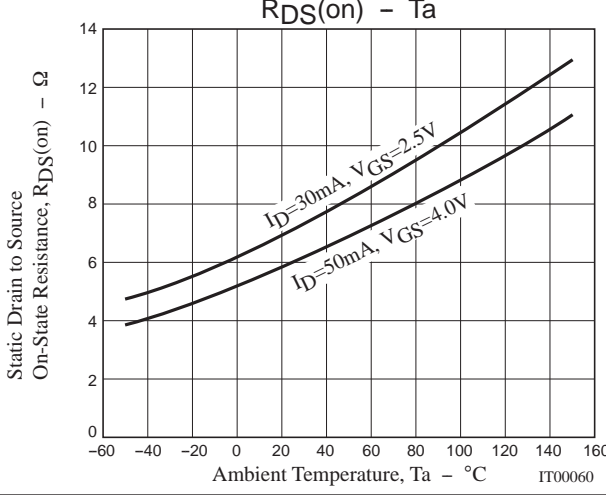
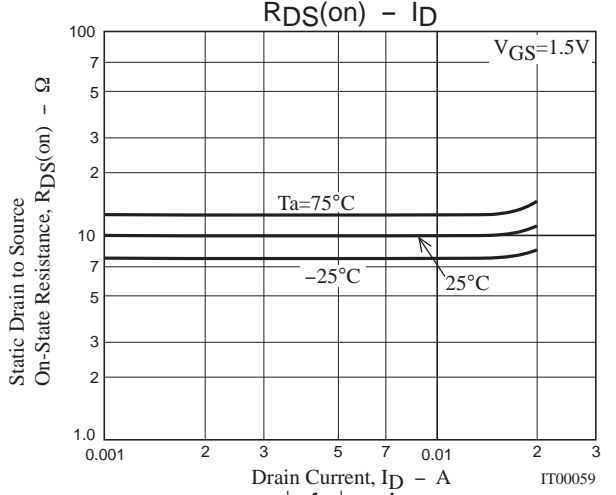
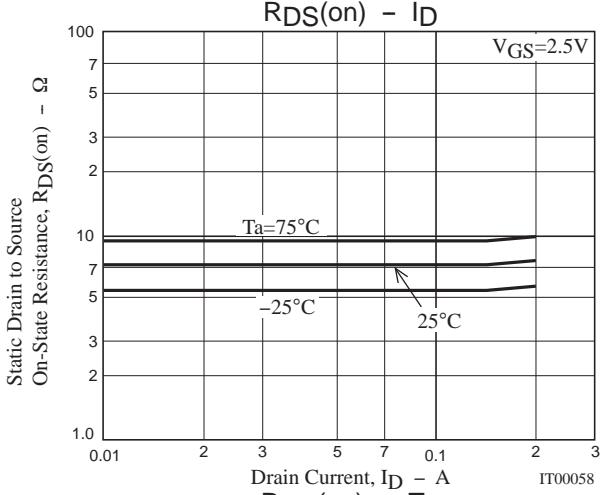
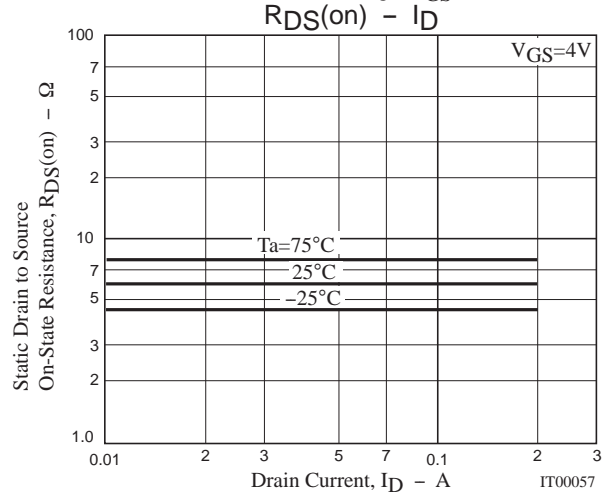
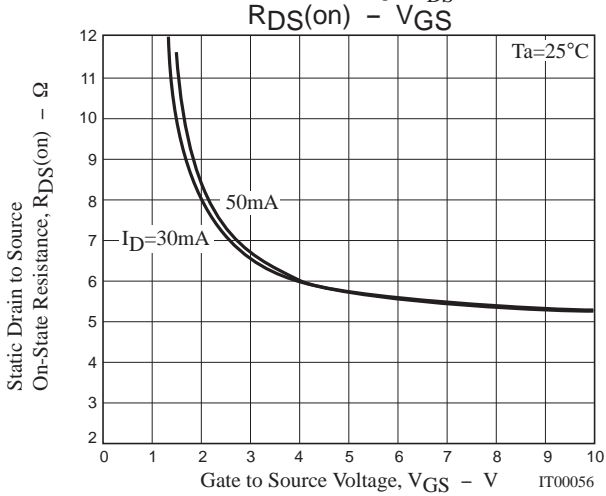
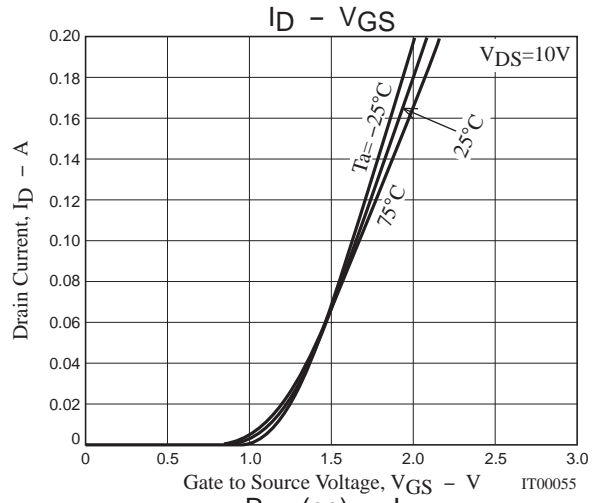
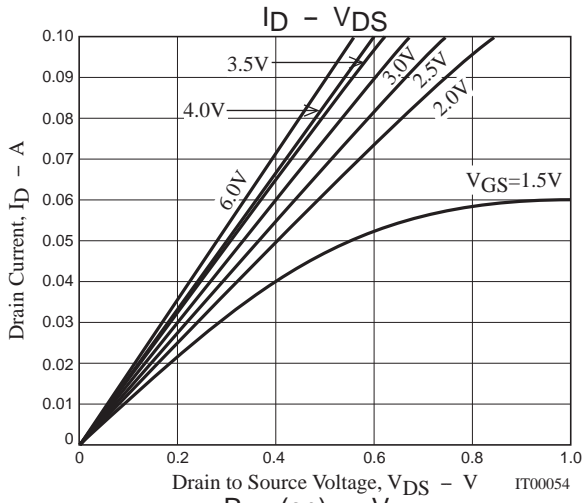

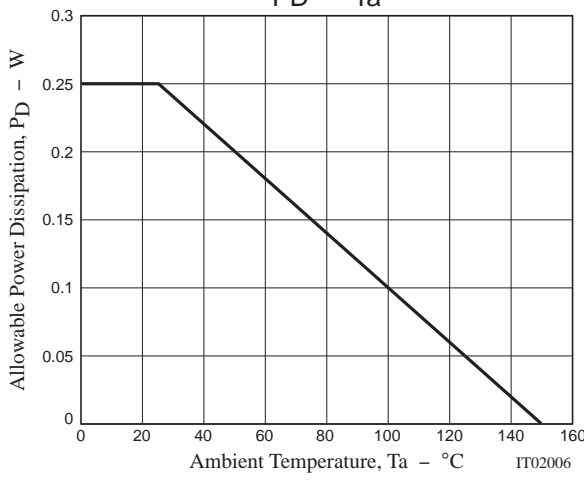
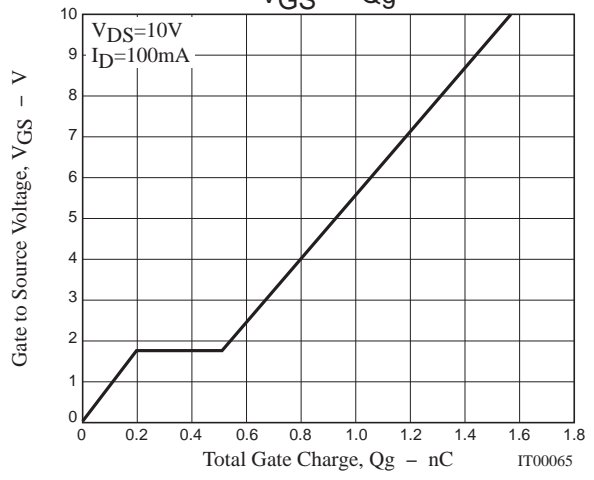
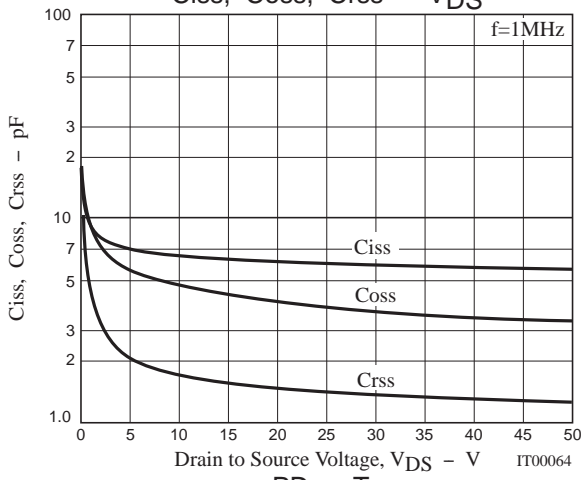
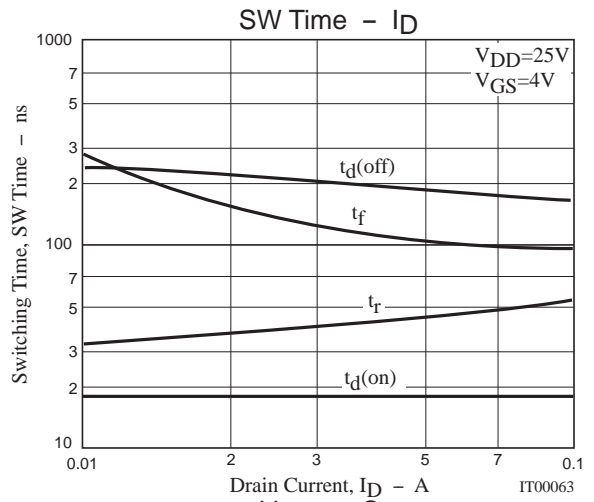
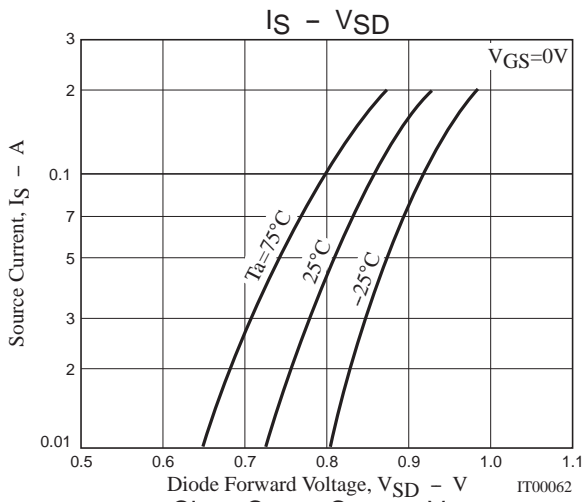

# 5LN01C

## Outline Drawing

5LN01C-TB-E, 5LN01C-TB-H

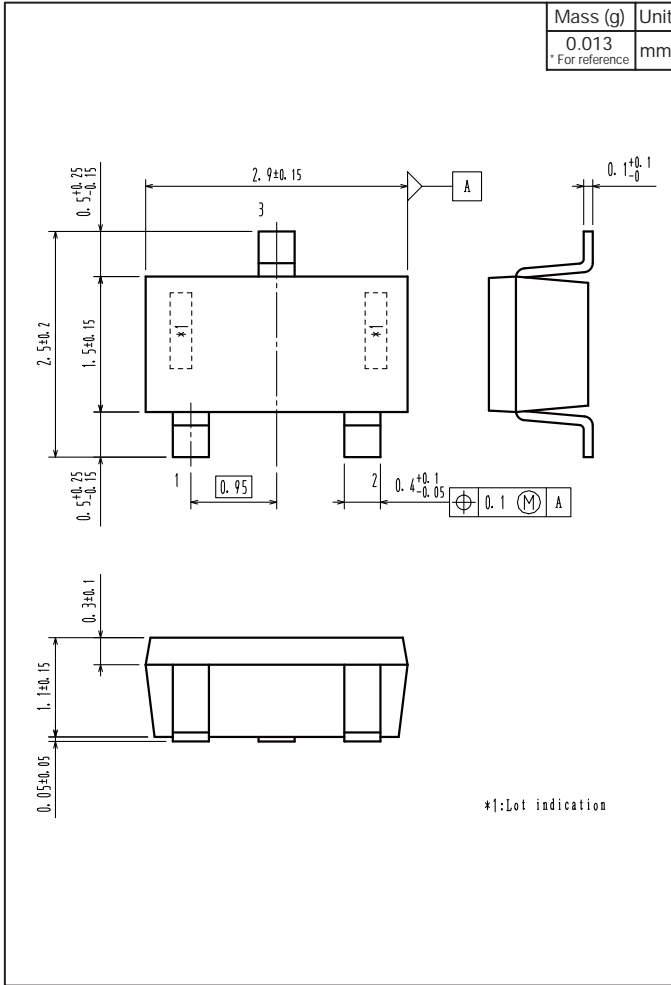

## Land Pattern Example

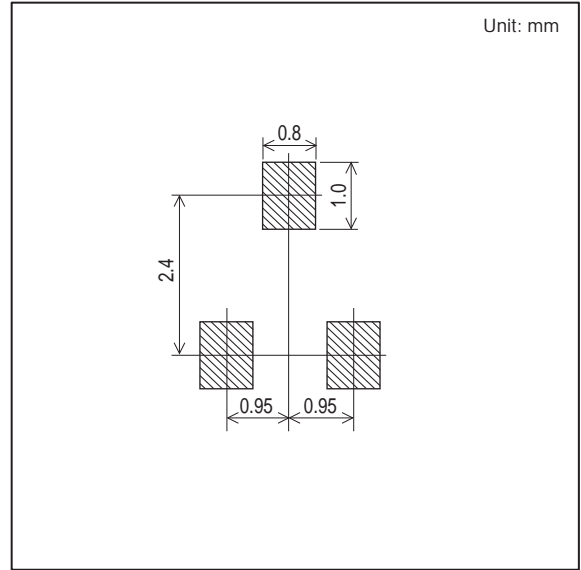

Note on usage : Since the 5LN01C is a MOSFET product, please avoid using this device in the vicinity of highly charged objects.

ON Semiconductor and the ON logo are registered trademarks of Semiconductor Components Industries, LLC (SCILLC). SCILLC owns the rights to a number of patents, trademarks, copyrights, trade secrets, and other intellectual property. A listing of SCILLC's product/patent coverage may be accessed at [www.onsemi.com/site/pdf/Patent-Marking.pdf](http://www.onsemi.com/site/pdf/Patent-Marking.pdf). SCILLC reserves the right to make changes without further notice to any products herein. SCILLC makes no warranty, representation or guarantee regarding the suitability of its products for any particular purpose, nor does SCILLC assume any liability arising out of the application or use of any product or circuit, and specifically disclaims any and all liability, including without limitation special, consequential or incidental damages. "Typical" parameters which may be provided in SCILLC data sheets and/or specifications can and do vary in different applications and actual performance may vary over time. All operating parameters, including "Typicals" must be validated for each customer application by customer's technical experts. SCILLC does not convey any license under its patent rights nor the rights of others. SCILLC products are not designed, intended, or authorized for use as components in systems intended for surgical implant into the body, or other applications intended to support or sustain life, or for any other application in which the failure of the SCILLC product could create a situation where personal injury or death may occur. Should Buyer purchase or use SCILLC products for any such unintended or unauthorized application, Buyer shall indemnify and hold SCILLC and its officers, employees, subsidiaries, affiliates, and distributors harmless against all claims, costs, damages, and expenses, and reasonable attorney fees arising out of, directly or indirectly, any claim of personal injury or death associated with such unintended or unauthorized use, even if such claim alleges that SCILLC was negligent regarding the design or manufacture of the part. SCILLC is an Equal Opportunity/Affirmative Action Employer. This literature is subject to all applicable copyright laws and is not for resale in any manner.

## Looking for pricing, stock, or lifecycle information?

Click below to explore more details on WIN SOURCE:

- ⊖ [View 5LN01C-TB-E on WIN SOURCE](#)
- ⊖ [ON Semiconductor](#) Information

## Optimize Your Supply Chain with WIN SOURCE Solutions

- ✓ Global Sourcing Solution
- ✓ Obsolete Management
- ✓ Cost Control Management
- ✓ Shortage Management
- ✓ Alternative Solution
- ✓ Excess Inventory Management